



841 S. 71st Avenue • Phoenix, AZ 85043
(623) 907-0081
www.performanceaccessories.com

CHEVY / GMC 2500 & 3500 DURAMAX DIESEL PICKUP BODY LIFT

INSTALLATION INSTRUCTIONS

03-05 2" KIT #PA10122

03-05 3" KIT #PA10123

MANUAL TRANSMISSION VEHICLES REQUIRE KIT PA4701

⚠ WARNING

Installation of a Performance Accessories body lift kit will change the vehicle's center of gravity and handling characteristics both on and off-road. You must drive the vehicle safely! Extreme care must be taken to prevent vehicle rollover or loss of control, which could result in serious injury or death. Avoid sudden sharp turns or abrupt maneuvers and always make sure all vehicle occupants have their seat belts fastened.

⚠ WARNING

Before you install this kit, read and understand all instructions, warnings, cautions, and notes in this instruction sheet and in the vehicle owner's manual.

⚠ CAUTION

Proper installation of this kit requires knowledge of the factory recommended procedures for removal and installation of original equipment components. We recommend that the factory shop manual and any special tools needed to service your vehicle be on hand during the installation. Installation of this kit without proper knowledge of the factory recommended procedures may affect the performance of these components and the safety of the vehicle. We strongly recommend that a certified mechanic familiar with the installation of similar components install this kit.

⚠ WARNING

DO NOT combine suspension, body, or other lift devices. Use of vehicle with combined lifts may result in unsafe and/or unexpected handling characteristics.

⚠ WARNING

This kit should only be installed on a vehicle that is in good working condition. Before you install the kit, thoroughly inspect the vehicle for corrosion or deformation of the sheet metal around the factory body mounts. If the vehicle is suspected to have been in a collision or misused, do not install this kit. Off-road use of your vehicle with this kit installed may increase the stress applied to the factory body mounts. We do not recommend that any vehicle with a body lift kit installed be involved in any extreme off-road maneuvers such as jumping. Failure to observe this warning may result in serious personal injury and/or severe damage to your vehicle.

⚠ WARNING

Many states and municipalities have laws restricting bumper heights and vehicle lifts. Consult state and local laws to determine if the changes you intend to make to the vehicle comply with the law.

⚠ WARNING

The installation of larger tires may reduce the effectiveness of the Braking System.

⚠ WARNING

Always wear eye protection when operating power tools.

⚠ WARNING

Before you install this kit, block the vehicle tires to prevent the vehicle from rolling.

⚠ WARNING

Accidental deployment of the air bag can result in serious personal injury or death. To avoid accidental deployment during installation of the kit, the Supplemental Restraint System (SRS, or airbag) must remain deactivated. Do not allow anyone near the airbag during installation. Refer to the factory service manual or owner's manual for the recommended procedure to disable the SRS. After you install the kit, reactivate the SRS before driving the vehicle.

⚠ NOTE

Performance Accessories recommends using the Loctite® supplied in the kit on the threads of all kit nuts and bolts unless specified otherwise in these instructions.

Before Starting Installation

NOTE
Kit parts are prefaced by the word **kit** and appear in **bold print**.

1. Carefully read all warnings and instructions completely before beginning.
2. Verify all parts have been received in this kit by checking the parts list at the end of this document.

NOTE
If parts are missing from kit, please be prepared to provide the following information:
1. **Name** of purchase location
2. **Bar Code** on side of box
3. **Date** above bar code
4. **Date** inside box cover
5. **Inspector #** from inside box cover

3. **Only install this kit on the vehicle for which it is specified.** If anytime during the installation you encounter something different from what is outlined in the instructions, call technical support at (928) 636-7080.

4. Special tools needed:
 - a. Die grinder or similar tool capable of cutting metal.
5. Park the vehicle on a clean, dry, flat, level surface and block the tires so the vehicle cannot roll in either direction.

A. Engine compartment

1. Battery cables
 - a. Disconnect battery cables from both batteries. Disconnect two negative cables first, then two positive cables.

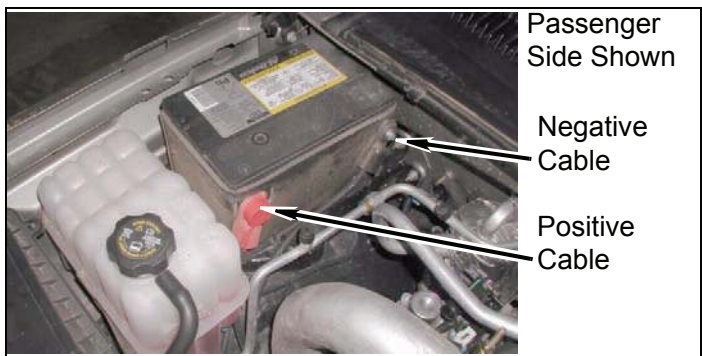

2. Airbag fuse
 - a. Remove cover and airbag fuse "SIR" from fuse panel. Fuse locations may vary. Check fuse chart on back of cover.



B. Measurements

1. Measure distance between the front bumper and front fenders. Record measurement.
Driver Side _____ Passenger Side _____
2. Measure distance between rear bumper and bed.
Driver Side _____ Passenger Side _____
3. Measure and record distance between cab and bed both sides.
Driver Side _____ Passenger Side _____

Prepare to install kit.

A. Front of vehicle

1. Grille
 - a. Remove cover from core support with seven push pins.

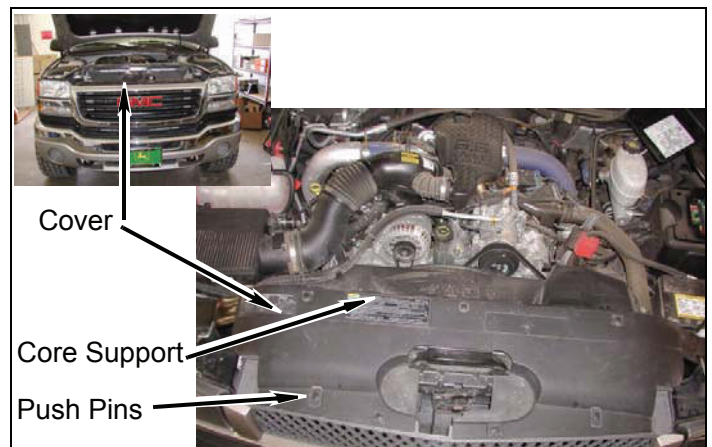

- b. Remove bolt, six clips, and grille from core support. Some GMC models may have extra clips.

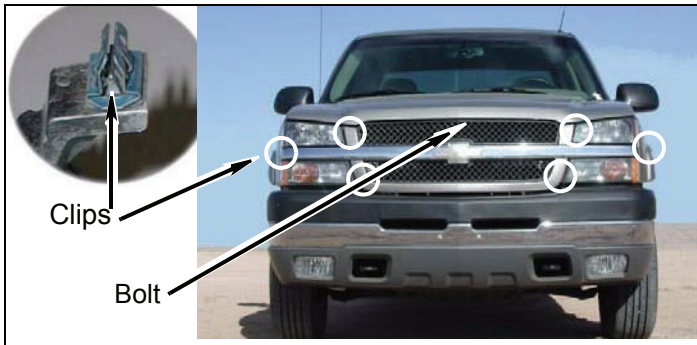

- d. Remove six bolts, and two tow hooks from frame.

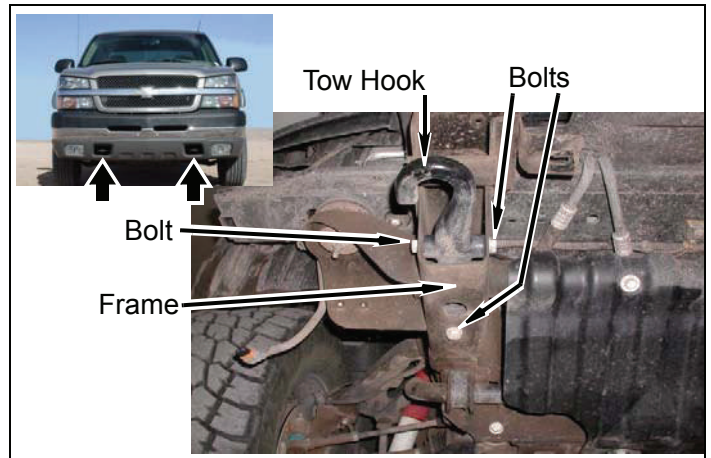

2. Front bumper

- a. If equipped, remove two connectors from two fog lamps.
- b. Remove six bolts and two front outer bumper braces from front bumper and frame.

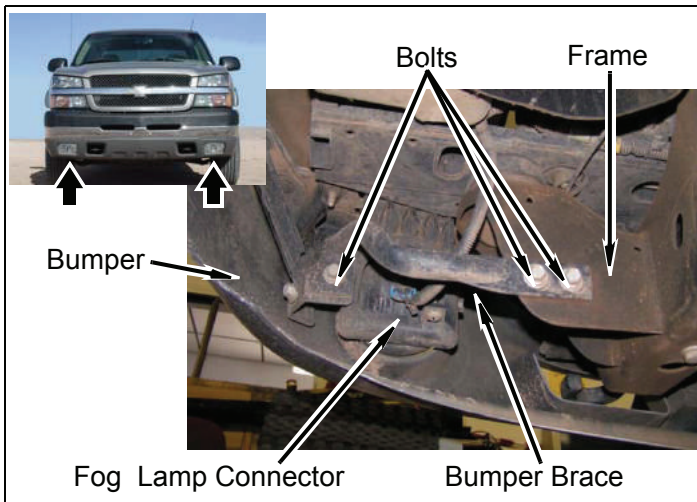

3. Plastic cover and air flap

- a. Remove five bolts, and plastic cover from frame and core support.

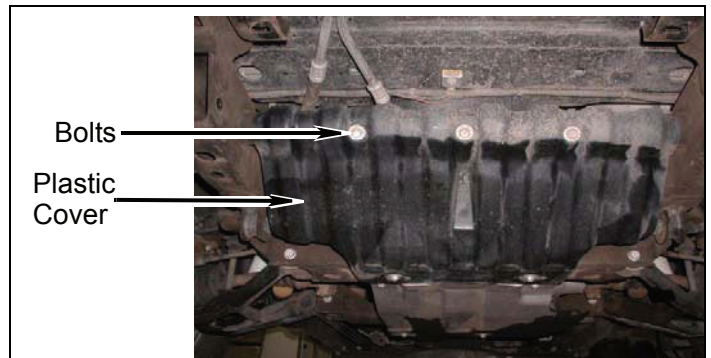

- b. Remove plastic cover from push clip, lower radiator hose and vehicle.

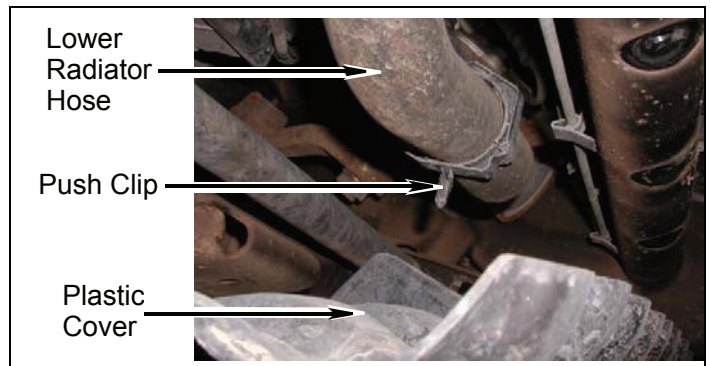

- c. Remove four bolts and front bumper from frame.

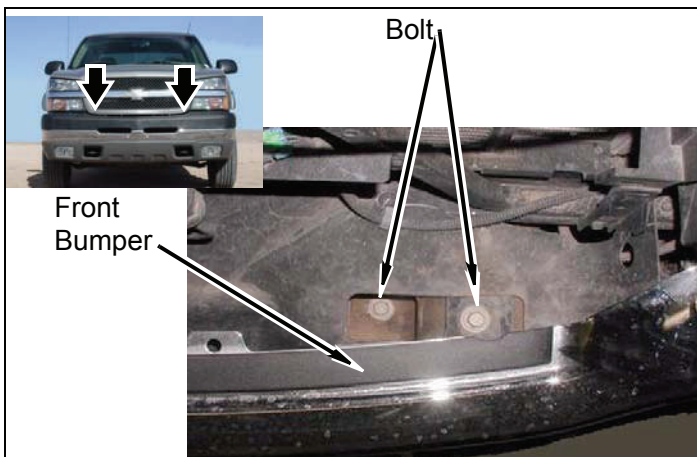

c. Outline transmission cooler hose on lower fan shroud as shown.

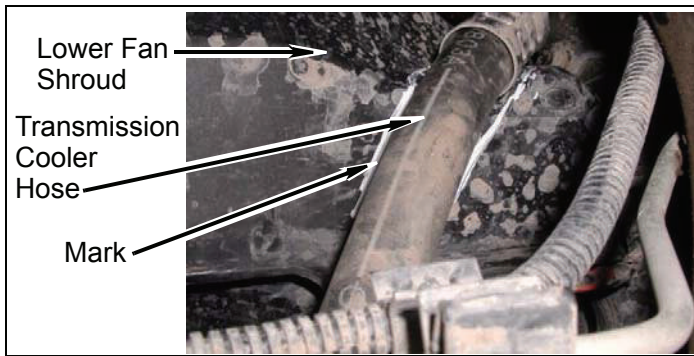

d. If equipped, remove clip and harness from air flap.

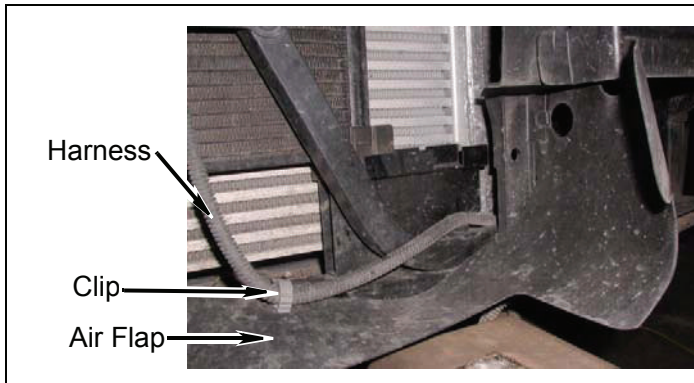

e. Remove two clips, three push pins, and air flap from core support.

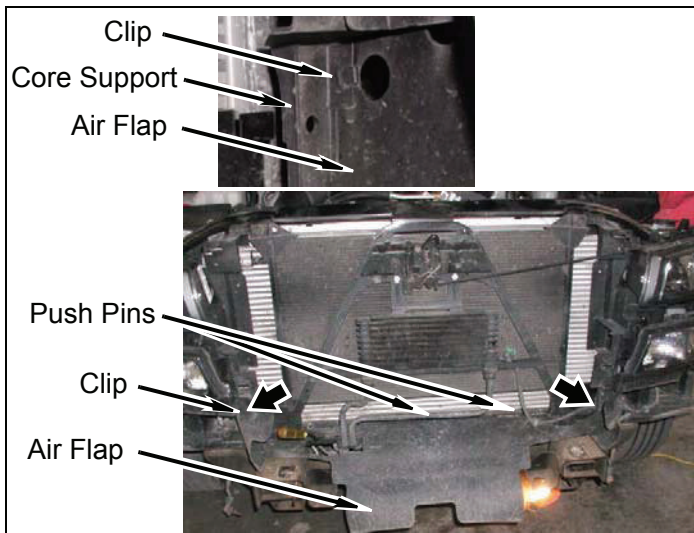

4. Transmission cooler

NOTE
Tie transmission cooler to core support so that it hangs free, and not binding hoses.

a. Remove two bolts, two push pins, and transmission cooler from core support.

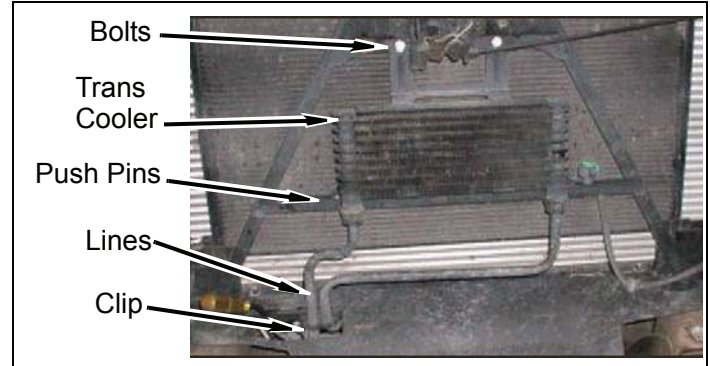

b. Remove two transmission cooler lines from clip.

B. Engine Compartment

1. Cooling system

WARNING
If the engine cooling system is hot, the coolant will be **HOT** and **UNDER PRESSURE**. To prevent serious personal injury, wait until the cooling system is completely cool before loosening the radiator cap.

NOTE
2003 2" lift kit; heater hose replacement and draining of coolant NOT necessary.

a. Carefully loosen radiator cap.

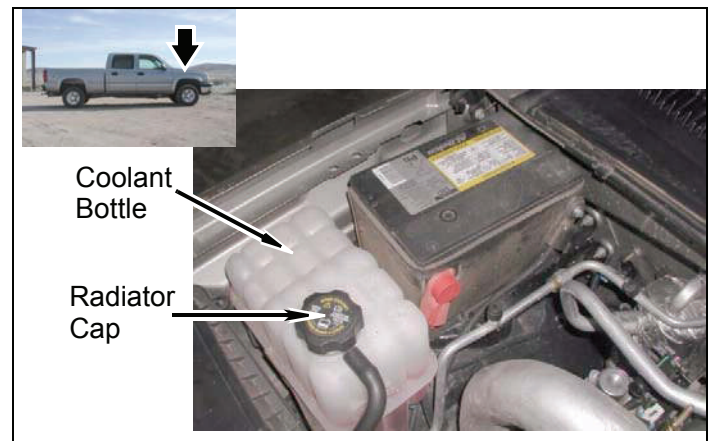

- b. Drain approximately two gallons of anti-freeze from radiator using drain valve, into a clean container.

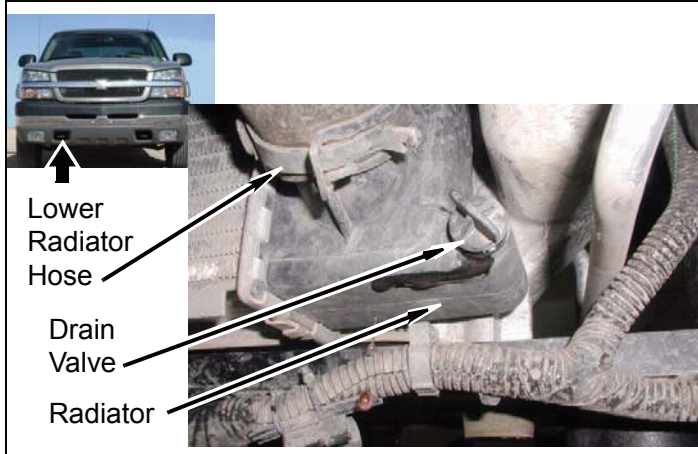

2. Air intake

- a. Loosen clamp and remove torx bolt from air baffle and air intake assembly.

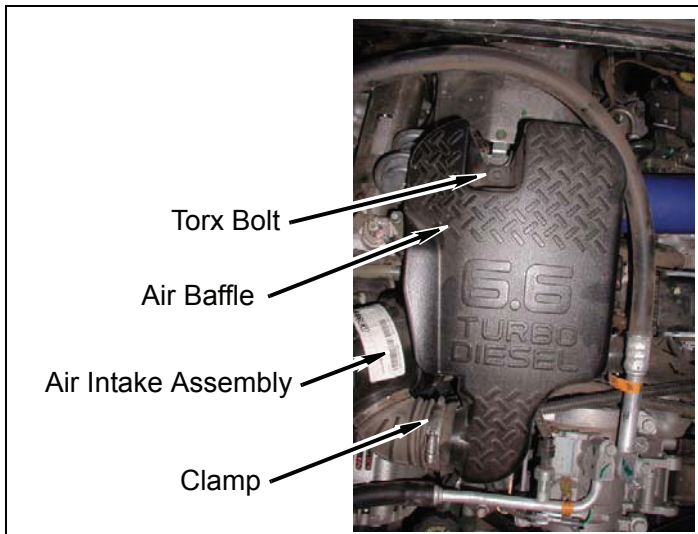

- b. Rotate air baffle up and forward from intake as shown and loosen clamp.

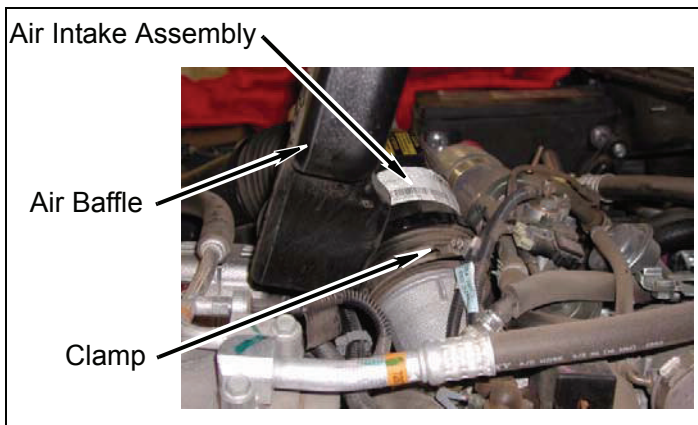

CAUTION
The turbocharger inlet should be covered or plugged to prevent foreign objects from entering the inlet and damaging the turbocharger or engine.

- c. Loosen clamp and remove air intake assembly from turbo inlet and air filter housing.

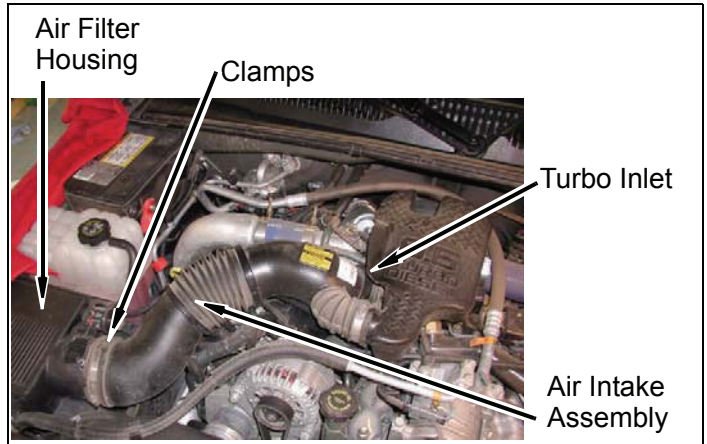

- d. Remove A/C hose from clip on upper fan shroud.

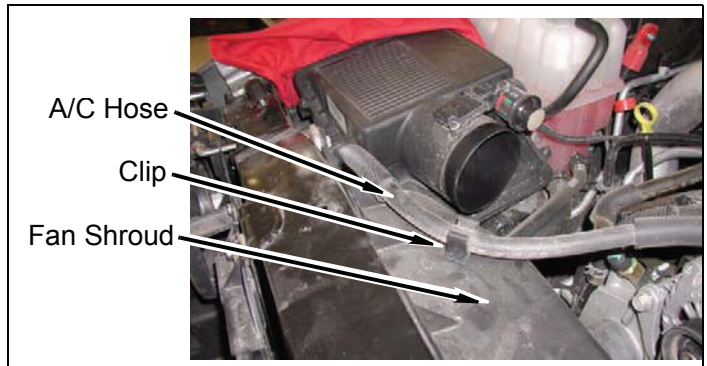

3. Fan shroud

- a. Remove four bolts from computer cover, upper fan shroud, and core support.

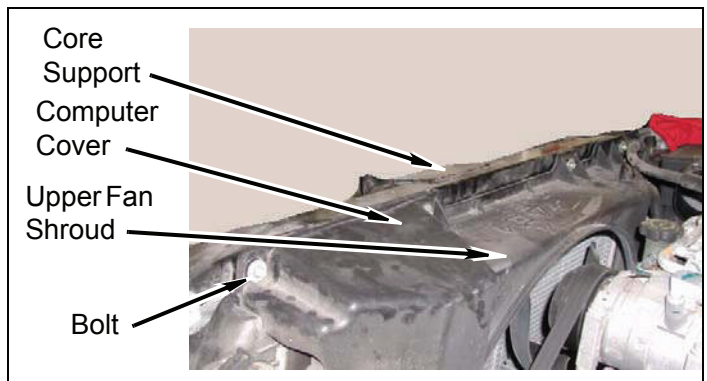

⚠CAUTION

Do not disconnect wiring harnesses from computer module.

- b. Lift up and back to remove computer module and computer cover from fan shroud. Rest assembly on power steering belt/pump.

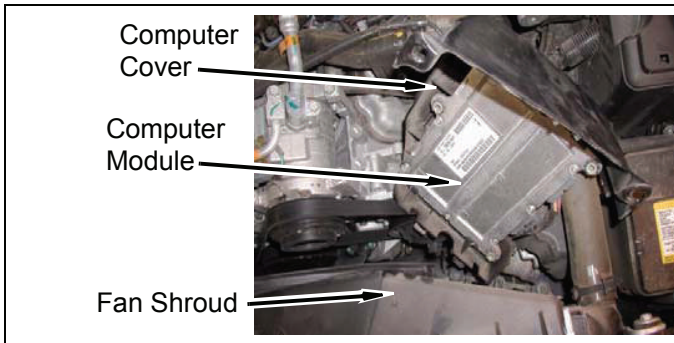

- c. Remove four pop-ups and upper fan shroud from vehicle.

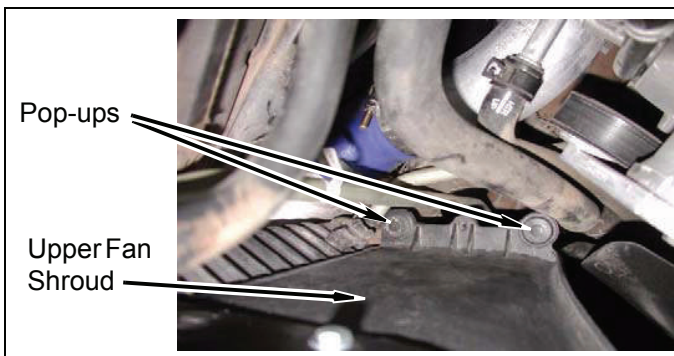

- d. Remove computer wiring harness from harness push clip and lower fan shroud.

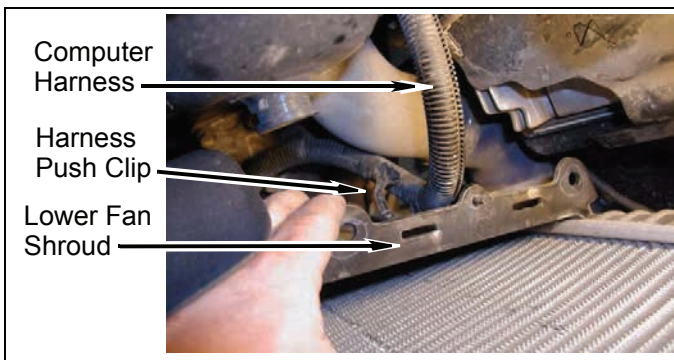

- e. Lift lower fan shroud from radiator clips on side of radiator body.

⚠NOTE

The following step, requires two people to position lower fan shroud under radiator.

- f. Remove two bolts, intercooler, and radiator from core support. Lift intercooler and radiator. Do not remove from vehicle. Carefully push lower fan shroud down under radiator and core support.

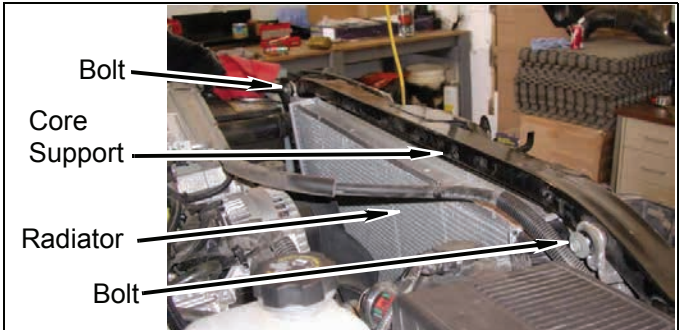

- g. Lower intercooler and radiator and install on core support with two bolts.

4. Heater and intercooler piping

- a. Heater hoses.
2003 3" lift kit; remove two clamps and outside heater hose.
2004 2" and 3" lift kit; remove two clamps and inside heater hose.

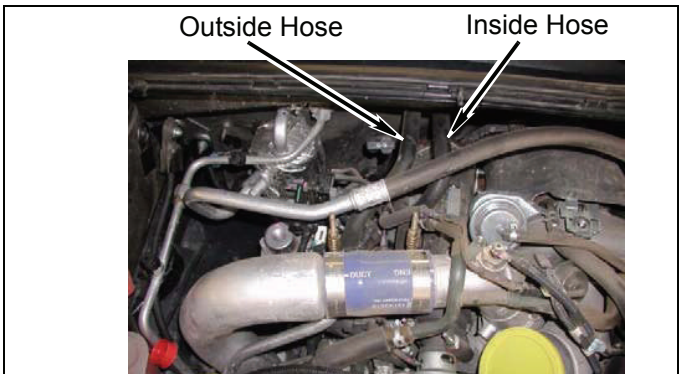

- b. Install kit **heater hose 5/8" x 14"** and two kit **hose clamps #28**, on fire wall and heater piping. Do not tighten at this time.

5. Intercooler piping passenger side

- a. Remove clamp, silicone hose and intercooler piping from turbo outlet passenger side.

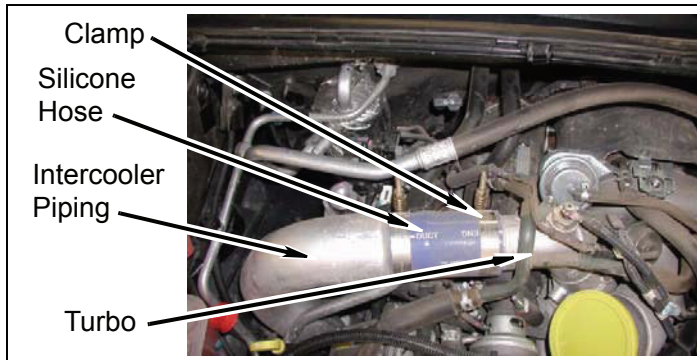

- b. Remove clip and harness from engine mounted bracket.

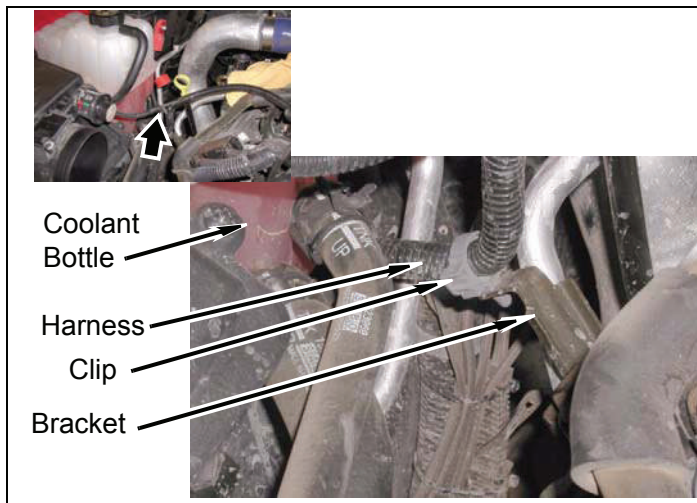

- c. Remove two clamps, silicone elbow, and intercooler piping from intercooler inlet.

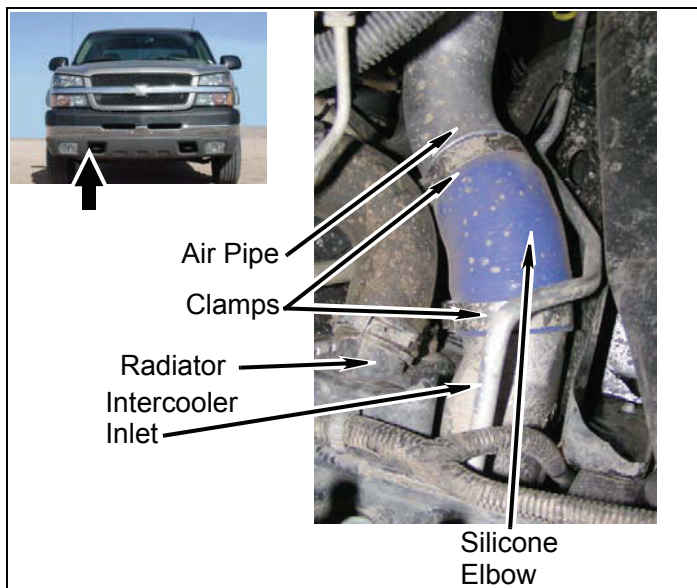

6. Intercooler piping drivers side

- a. Loosen two clamps, silicone elbow, and intercooler piping from intercooler. Do not remove.

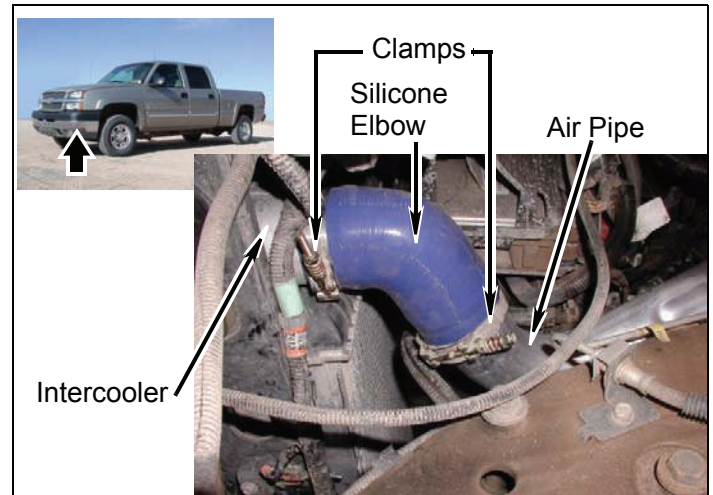

NOTE
Ensure steering shaft does not turn independently of the steering gearbox. This could cause the air bag system to malfunction, resulting in serious personal injury or damage to the equipment.

7. Steering shaft

- a. Straighten steering wheel and strap the wheel so it will not turn.
- b. Remove bolt and nut from upper and lower steering shaft.

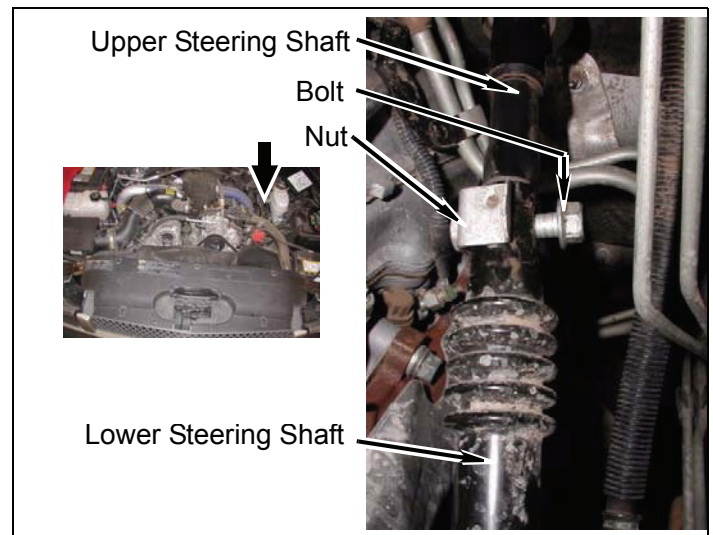

- c. Slide upper steering shaft up to separate from lower steering shaft.

8. Wiring harnesses and ground strap

- a. Remove nut and ground strap from stud on fire wall.

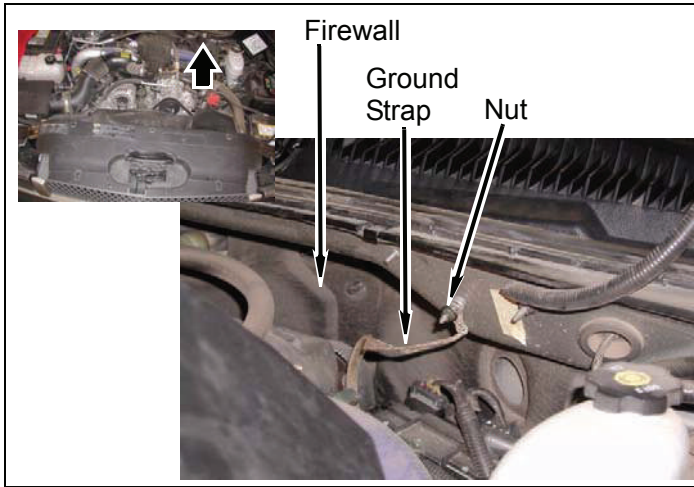

- b. Remove harness from clip and bracket.

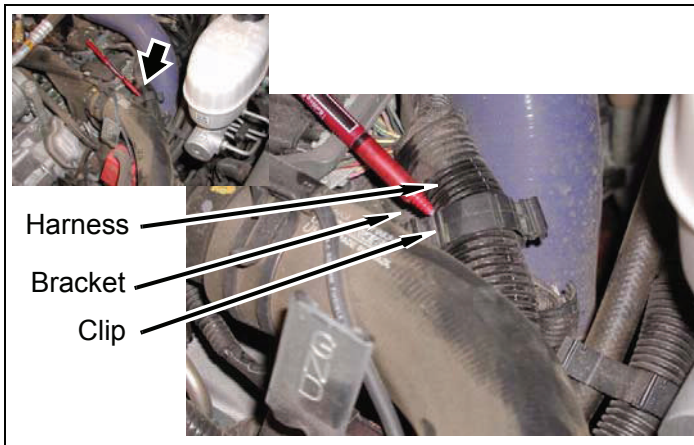

- c. Remove two clips and harness from cover and inner fender.

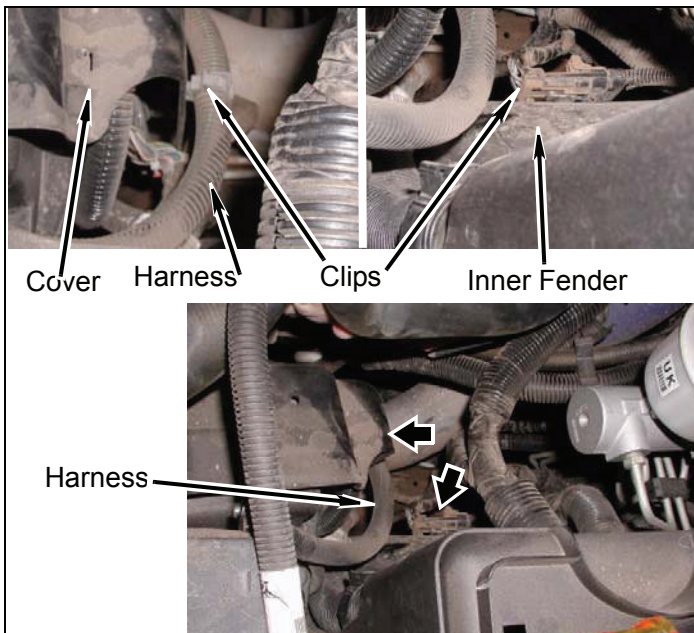

9. Wiring harnesses and power steering drivers side

- a. Remove bolt and two ground wires from frame.

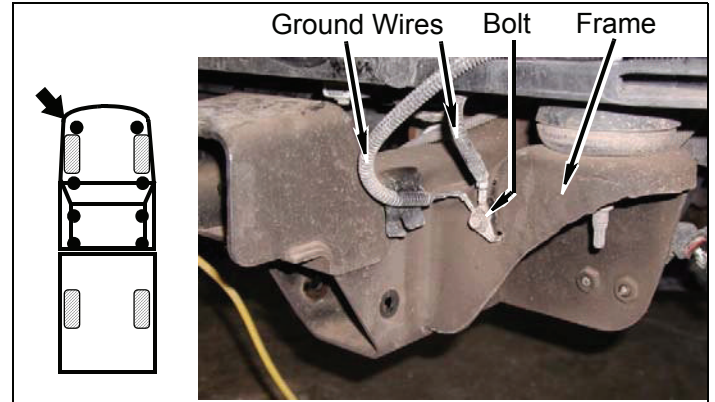

NOTE

Driver side inner fender well was removed for clarity and ease of access.

- b. Remove clip and harness from frame and shock tower driver side.

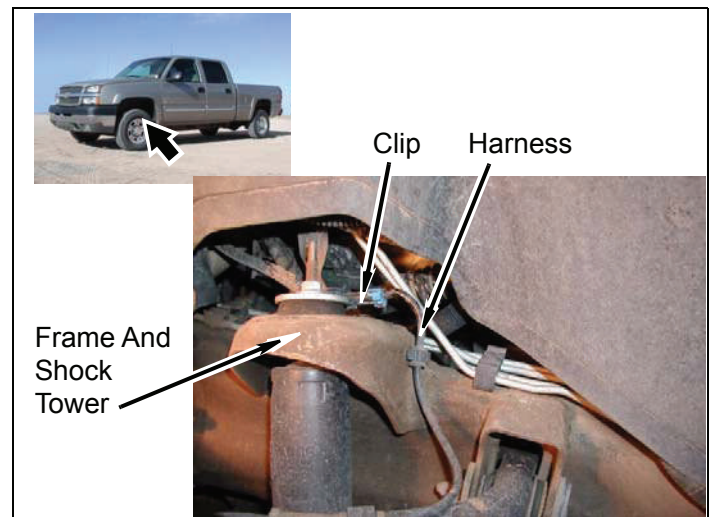

- c. Carefully bend power steering pressure line at power steering pump by pulling toward fire wall as shown. Do not allow line to kink.

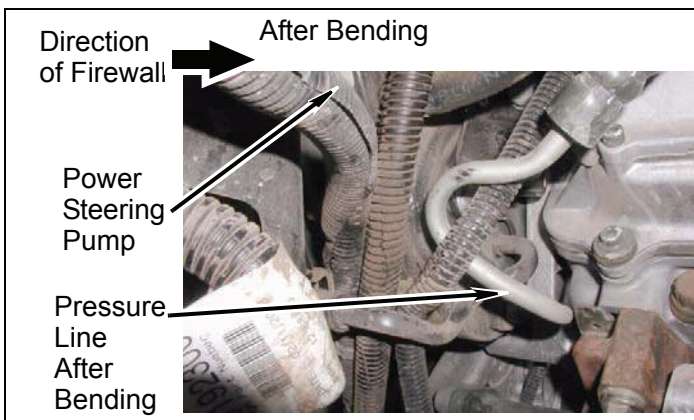
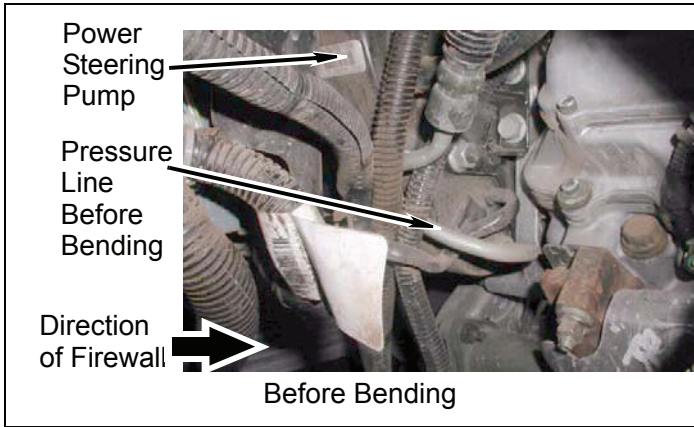

- d. Carefully bend power assist pressure line up toward hood, to clear accumulator on brake hydroboost.

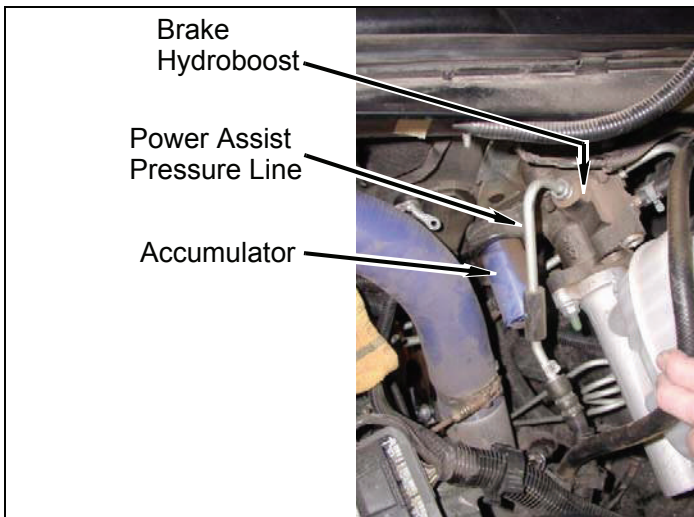

- e. Loosen power assist pressure line fitting at brake hydroboost housing and position power assist pressure line along side of accumulator as shown.

- f. Tighten power assist pressure line fitting at brake hydroboost housing.

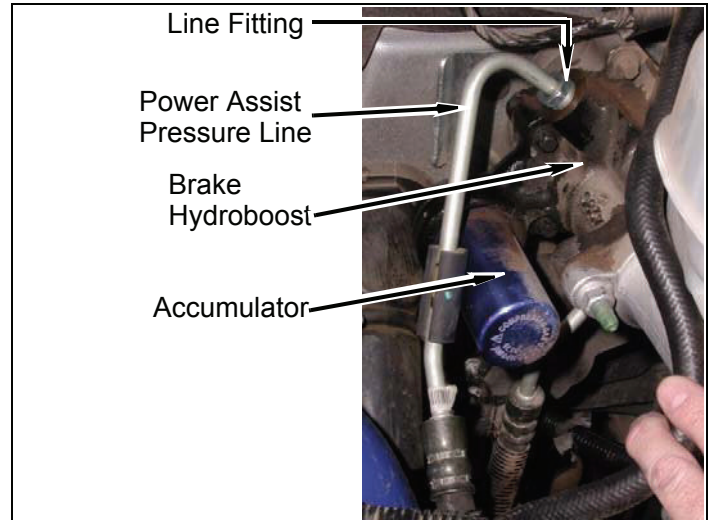

- g. Remove bolt, clamp, and power assist pressure line from frame.

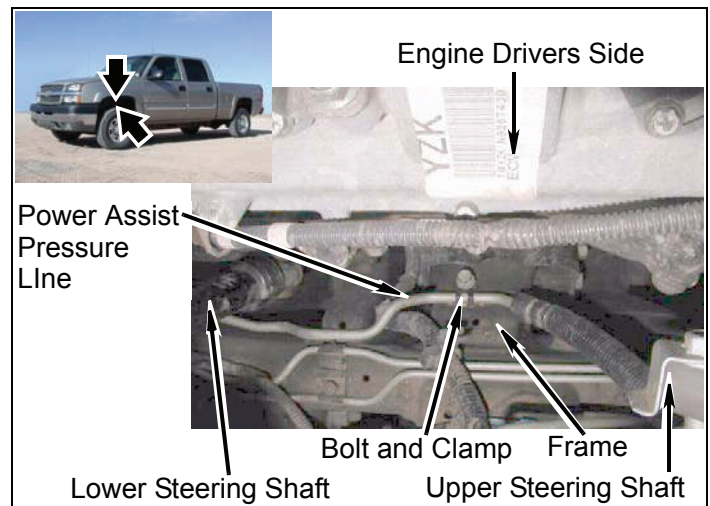

- h. Remove two brake lines from two sets of clips driver side frame.

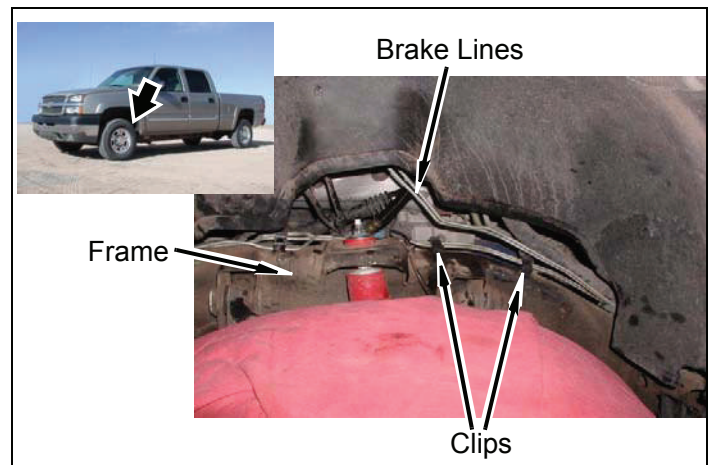

10. **Manual transmission:** shift lever

- a. Remove four screws, four pop-ups, and shift boot from floorboard. Lift shift boot up out of the way.

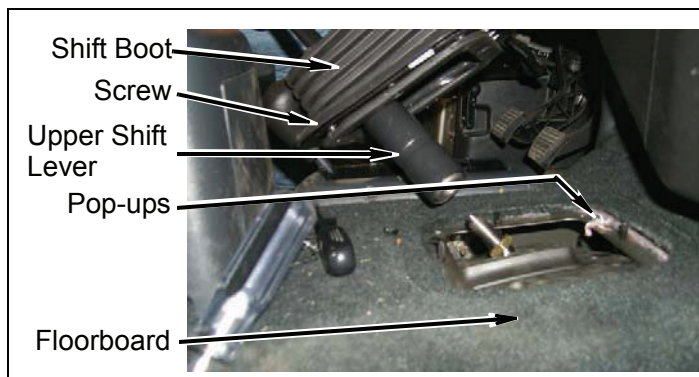

- b. Mark upper shift lever and shift lever input shaft to maintain alignment during installation.

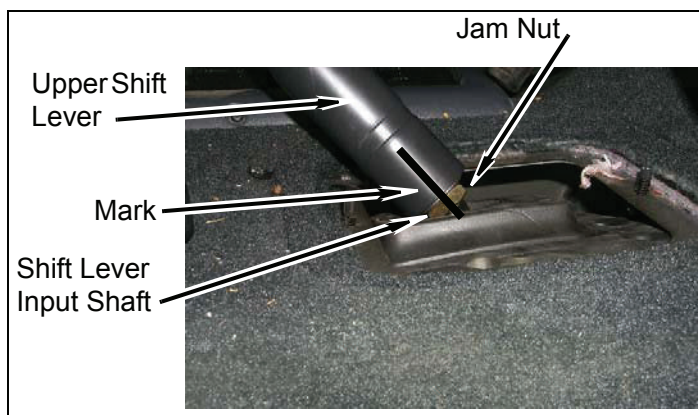

- c. Loosen jam nut and remove upper shift lever from shift lever input shaft.

C. Frame

1. Parking brake cable

- a. Remove bolt and ground wires from driver side frame mounting pad.

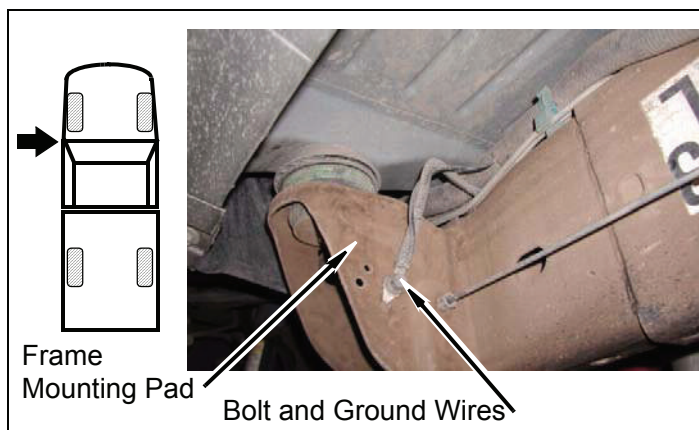

- b. Pull some slack in parking brake cable. Clamp two cables at cable housing where indicated by arrows.

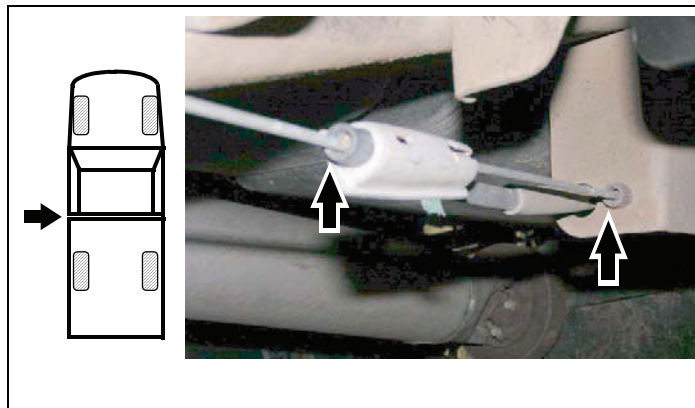

- c. Separate front parking brake cable from rear parking brake cable at cable connector.

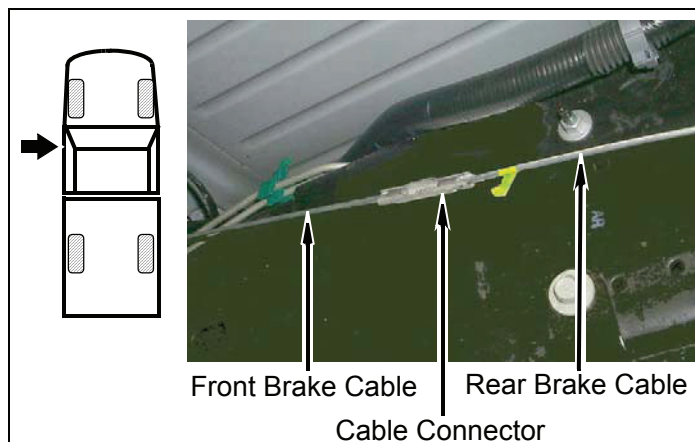

- d. Remove front brake cable and brake cable housing from front frame mounting pad.

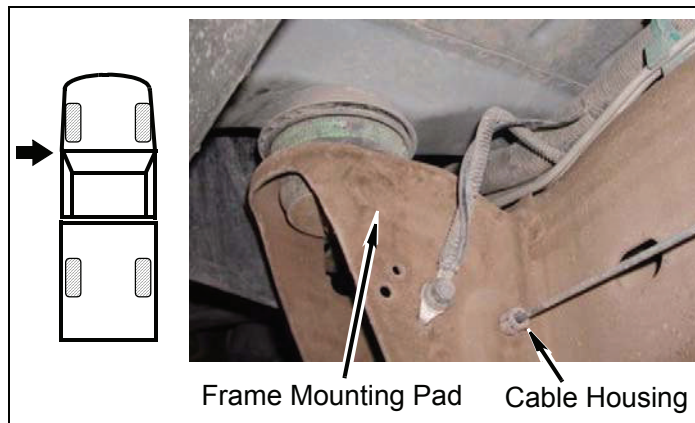

2. Manual transfer case: shift linkage

- a. Remove clip containing three metal lines from bracket.

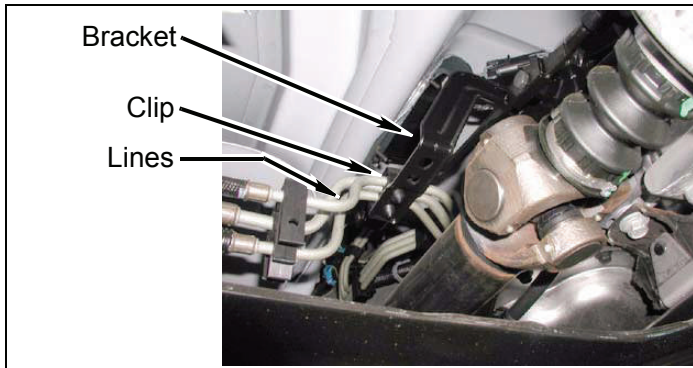

- b. Remove two nuts and bracket from transfer case. Bracket is not reused. Install two nuts and tighten.

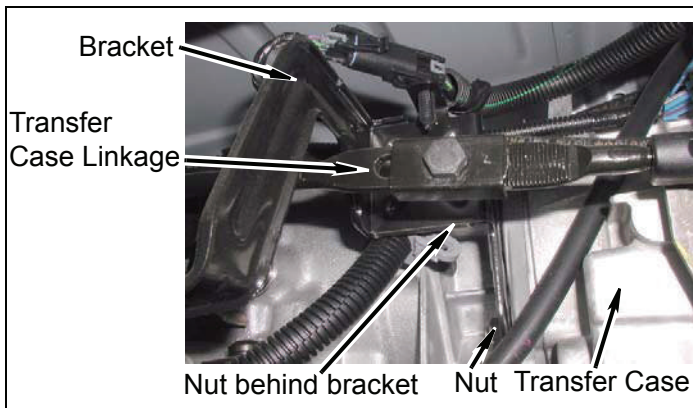

- c. Remove two clips and transfer case linkage from transfer case and pivot.

3. Single cab only: Safety cables

- a. If applicable, remove two bolts and safety cables from two rear frame mounting pads.

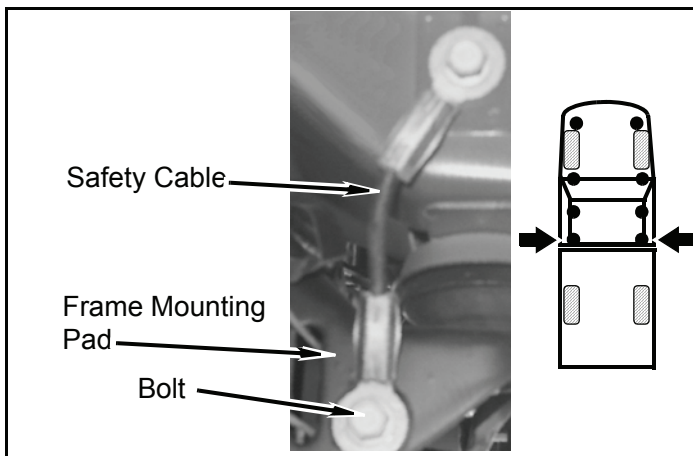

D. Rear of vehicle

⚠WARNING

Use extreme caution when working near fuel lines and fuel tank. Clean up spilled fuel immediately. Any spark could cause an explosion or fire resulting in serious personal injury and property damage.

1. Fuel filler

- a. Remove fuel cap, three bolts, and fuel filler from bed.

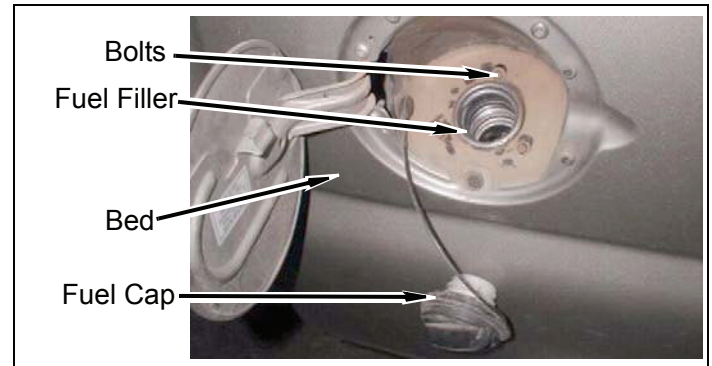

2. Rear bumper

⚠NOTE

Removal of spare tire might be helpful, but not mandatory (refer to the Owner's Manual).

- a. Unplug rear bumper light wiring harness from frame connector.

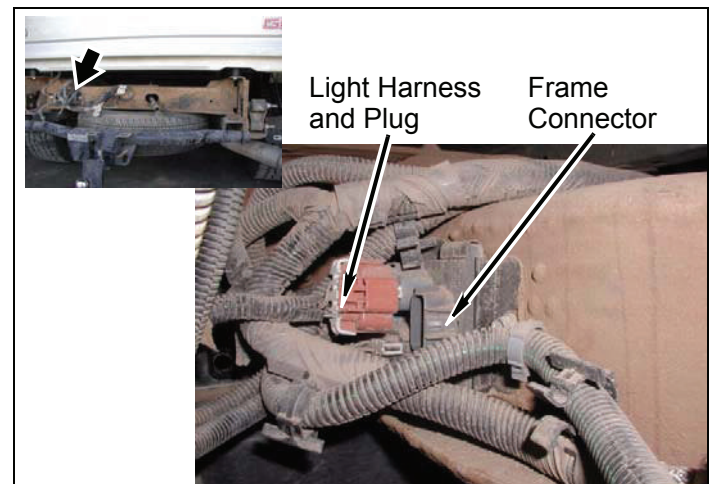

- b. Remove two bolts, four nuts, two bumper brackets, and two bumper braces from frame.

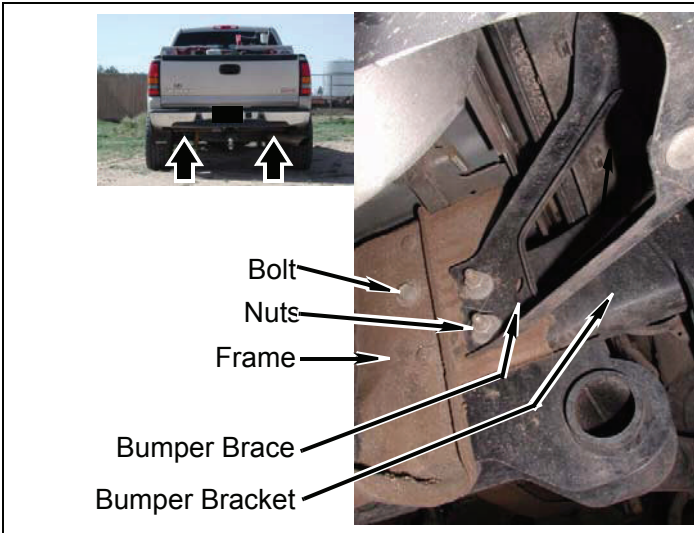

- c. If equipped with a trailer hitch, remove two short and two long bolts from hitch and frame.

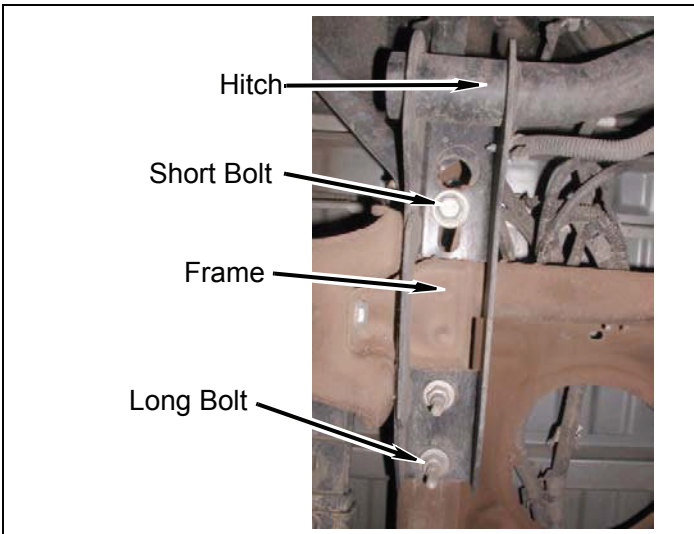

- d. Remove two bolts and bumper from hitch and vehicle.

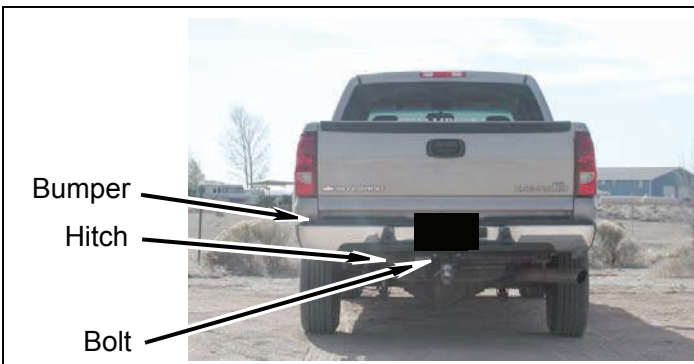

Install the kit

A. Cab

1. Prepare to lift cab from frame

⚠WARNING

Failure to replace the OEM body mounting hardware (except mounting bolts in the kit) in the stock locations could result in serious personal injury or damage to the vehicle.

⚠NOTE

Ensure stock spacers and body bushings stay on vehicle unless otherwise specified in these instructions. Kit lift **blocks** are installed in addition to the stock spacers and body bushings.

- a. Loosen but do not remove, core support bolt and three cab bolts from drivers side cab.

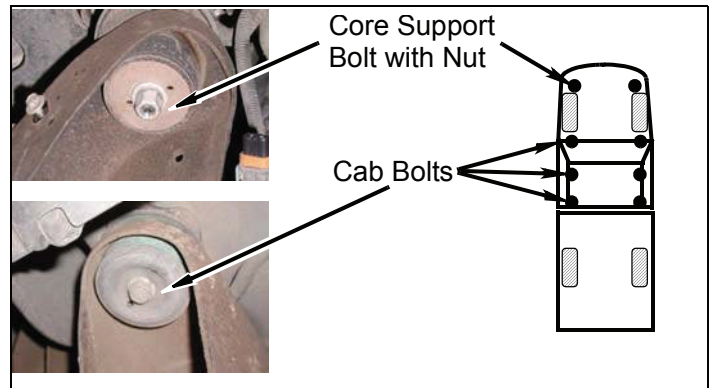

- b. Remove core support bolt, nut, and three cab bolts from passenger side cab.

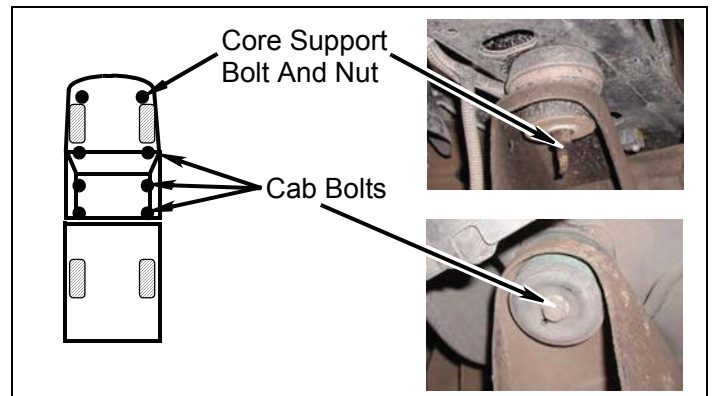

2. Passengers side

⚠CAUTION

Continually check hoses, wires, lines, etc. to be sure that everything is flexing properly and not binding, or damage to the vehicle could result. Be especially careful of the a/c hoses at the fire wall, the belt pulley, and at the core support. Ensure brake lines extend while lifting. Bending the lines to gain ample slack may be necessary. Be extremely careful not to kink the lines.

⚠WARNING

Use extreme caution when lifting body from frame. Ensure lifting device is securely placed. Keep hands out from between frame and body, or serious personal injury could result.

- a. Using a hydraulic jack and a wooden block, slowly lift cab high enough to position a kit lift **block** between core support and body bushing. Position three kit lift **blocks** between cab and remaining body bushings.

⚠NOTE

2" kit use bolts 12mm x 1.75 x 160mm

- b. Install a kit **lift block** under core support and on top of upper body bushing, frame, and lower body bushing with a kit **bolt** (12mm-1.75 x 180mm), kit **washer** (1/2" thick), and stock nut. Do not tighten.

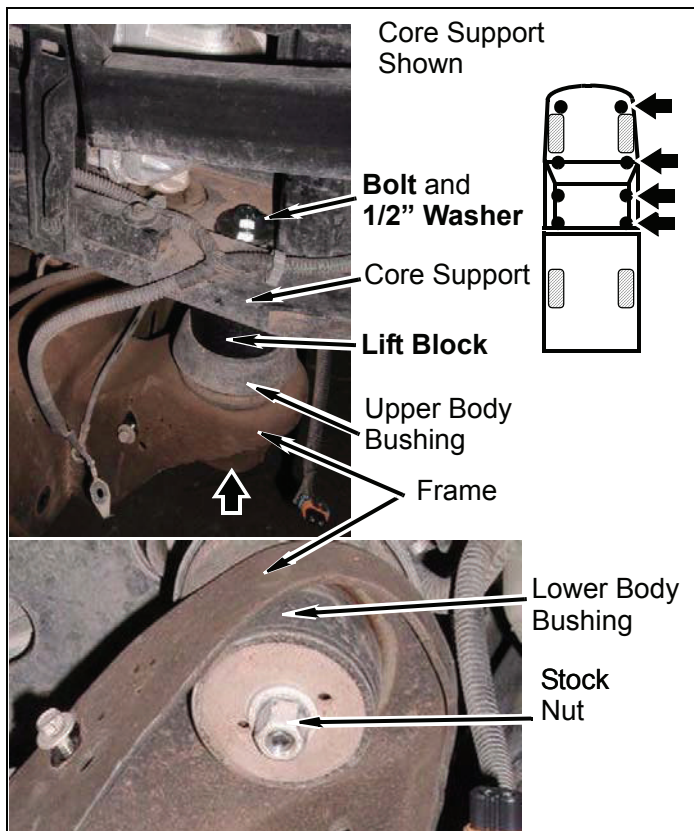

⚠NOTE

2" kit use bolts 12mm x 1.75 x 160mm

- c. Install three kit lift **blocks** under body and on top of top body bushings, frame, and lower bushings, with three kit **bolts** (12mm-1.75 x 180mm) and kit **washers** (7/16" USS). Do not tighten.

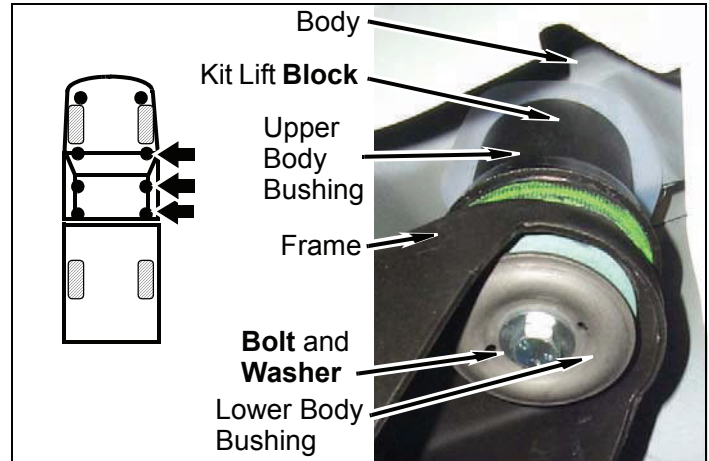

- d. Lower cab onto kit lift **blocks**.

3. Drivers side

- a. Repeat above steps for the cab driver side.
- b. Adjust cab to bed clearance as needed using measurements taken earlier.

4. Finish cab lift **block** installation

- a. Remove eight **bolts** one at a time, place a few drops of kit **Loctite**® on threads, install and tighten to 55ft.lbs.

B. Bed

1. Prepare to lift bed from frame.

- a. Loosen but do not remove four bed bolts driver side (short bed three bolts).

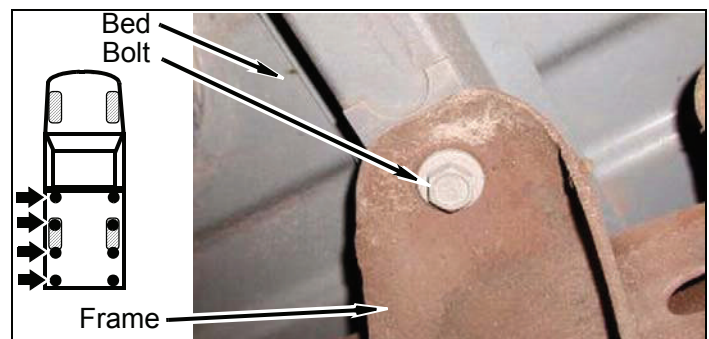

- b. Remove four bed bolts from frame passenger side.

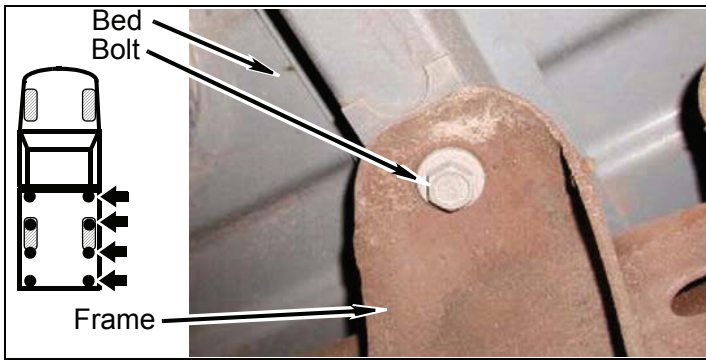

2. Bed passenger side

- a. Using a hydraulic jack and a wooden block, slowly lift the bed high enough to position the kit lift **blocks** between bed and frame mounting pads.
- b. Position three kit lift **blocks** (3" Diameter) and one kit (2" Diameter) lift **block** between bed and frame as shown.

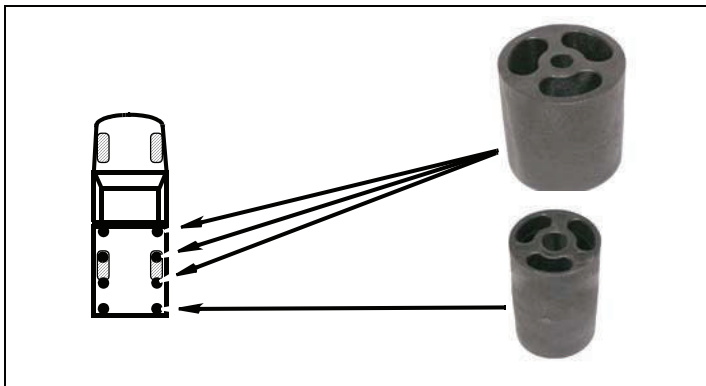

NOTE
2" kit use bolts (12mm-1.75 x 80mm) for following step.

- c. Install kit lift **blocks** on frame and bed with four kit **bolts** (12mm-1.75 x 100mm) and four kit **washers** (7/16" USS). Do not tighten.

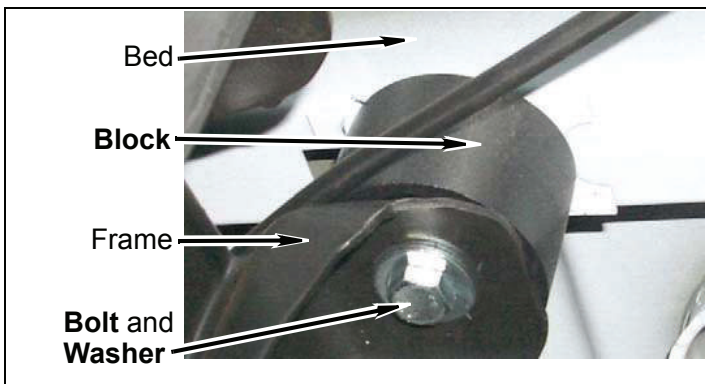

- d. Lower bed onto kit lift **blocks**.
3. Install driver side bed kit lift **blocks**.
 - a. Repeat above steps for driver side.
 4. Finish the bed kit lift **block** installation.

NOTE
Place a few drops of Loctite® on threads of all bolts.

- a. Adjust bed to cab clearance as needed using measurements taken earlier.
- b. Remove eight kit **bolts** one at a time, place a few drops of kit Loctite® on threads, install and Tighten to 55ft.lbs.

C. Rear of vehicle

WARNING
The following procedure is intended only to enhance the appearance of the vehicle. The rear bumper will no longer be rated for towing of any kind. Towing with the rear bumper after it has been lifted can result in death, serious personal injury, or damage to the vehicle. Towing after the bumper has been lifted should be accomplished using a rated Class III receiver type hitch.

1. Install rear bumper
 - a. Mark, cut, and bend crossmember for spare tire crank tube as shown.

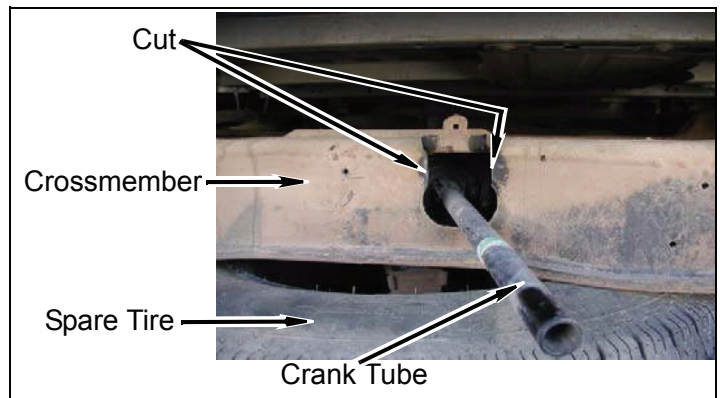

- b. Loosen, do not remove, four nuts from two outer bumper braces. Move slightly away from bumper brackets.
- c. Remove four nuts, four bolts, and two rear bumper brackets from rear bumper.

- f. **3" kit passenger side:** Install a kit **bracket** (3-stud) on outer bumper brace as shown, and rotate toward frame with inside stud through frame.

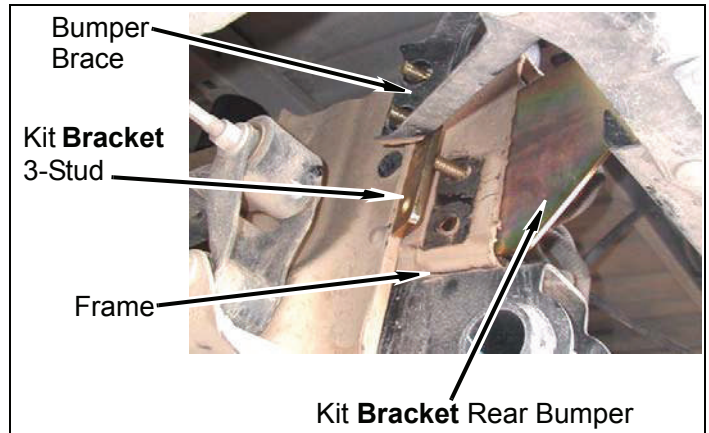
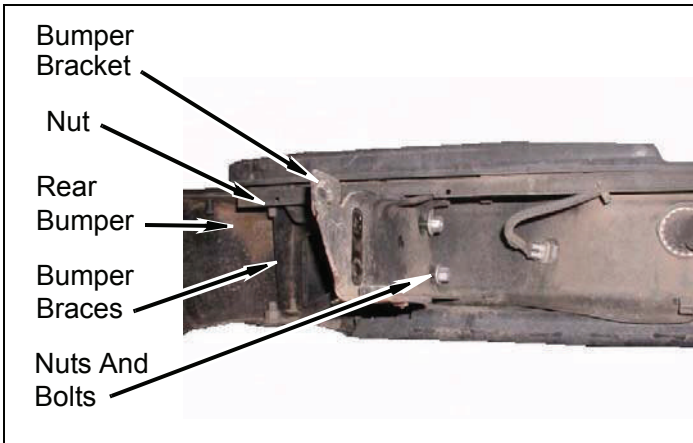

- d. Install two kit **brackets** (rear bumper) on rear bumper with four bolts and nuts. Do not tighten.

- g. **3" kit passenger side:** Install kit **bracket** (3-stud) on outer bumper brace with two kit **washers** (1/2" USS), and two kit **nuts** (1/2" nylock), on two studs as shown. Do not tighten

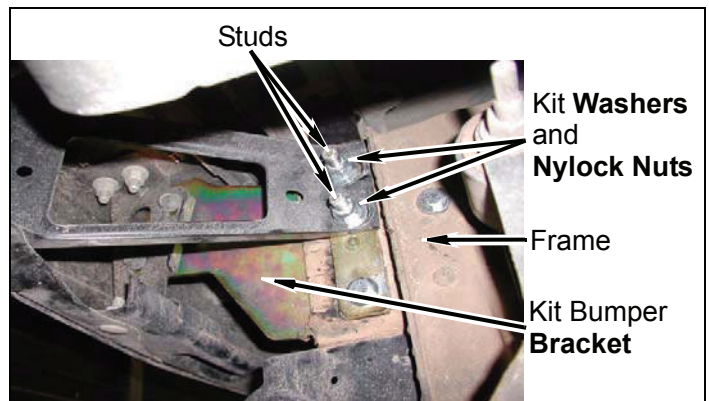
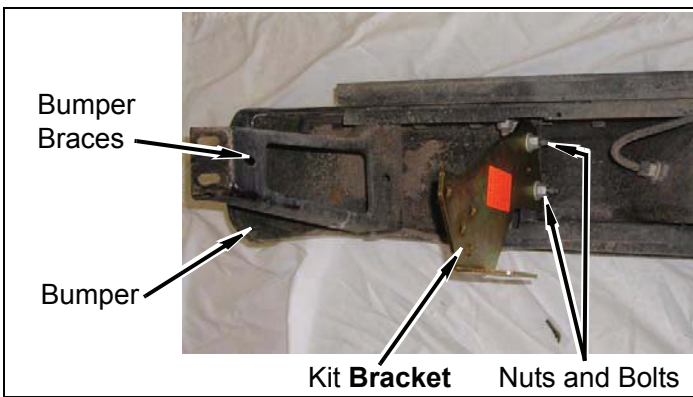

- e. Install bumper and kit **brackets** (rear bumper) in frame rails. Ensure spare tire crank tube is positioned in original hole in bumper.

- h. **3" kit passenger side:** Install kit **bracket** (3-stud), outer bumper brace, and kit **bracket** (rear bumper) on frame with a kit **bolt** (1/2" X 1 1/2"), three kit **washers** (1/2" USS), and two kit **nuts** (1/2" nylock). Do not tighten.

NOTE
Place a few drops of Loctite® on threads of all bolts.

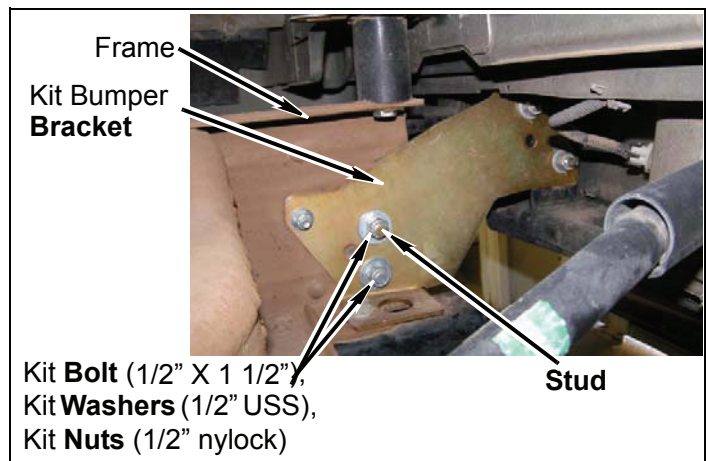

- i. **3" kit:** Repeat above steps for drivers side.
- j. **2" kit passenger side:** Install kit **bracket** (1-stud) on outer bumper brace with a kit **washer** (1/2" USS), and a kit **nut** (1/2" nylock), on stud as shown.
- k. **2" kit passenger side:** Install kit **bracket** (1-stud), outer bumper brace, and kit **bracket** (rear bumper) on frame with two kit **bolts** (1/2" x 1 1/2"), four kit **washers** (1/2" USS), and two kit **nuts** (1/2" nylock).

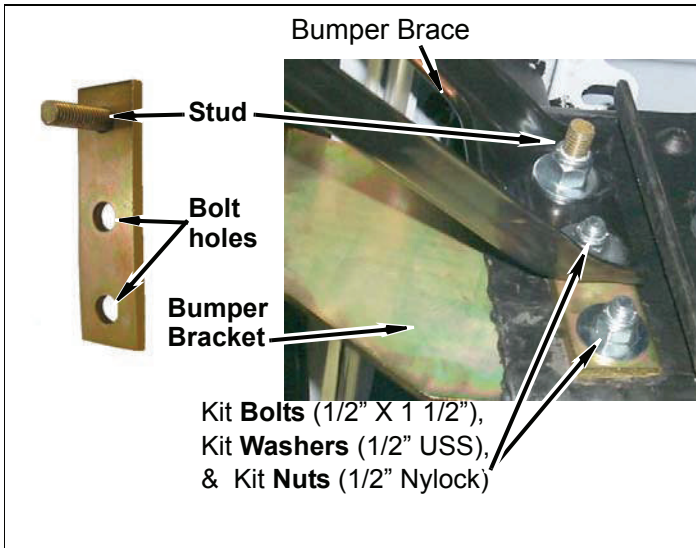

- l. **2" kit:** Repeat the above steps for drivers side.
- m. Install kit **bracket** (rear bumper) on frame with a kit **bolt** (3/8" x 1 1/2"), two kit **washers** (3/8" USS), and a kit **nut** (3/8" nylock). Do not tighten.

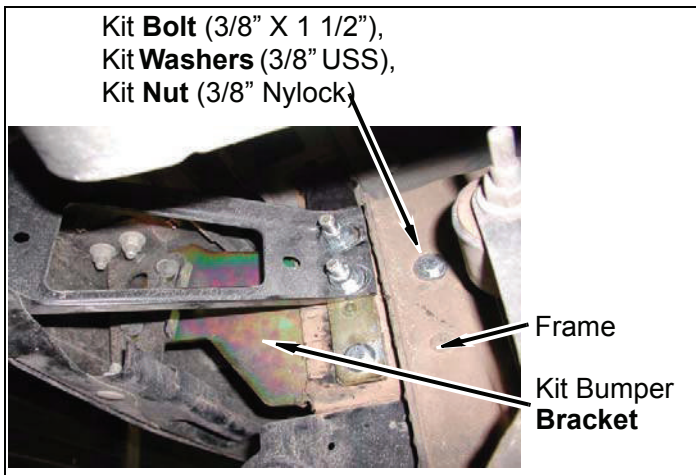

- n. Repeat the above steps for drivers side.

NOTE

2" lift uses kit **bolts** (14mm x 90mm) with kit **blocks** (2" x 2" large hole) spacer bracket not used.

- o. Install kit **bracket**, hitch spacer and two kit **blocks**, lift (3" x 2" large hole) as shown, on rear bumper and hitch with two kit **bolts** (14mm x 110mm) and two kit **washers** (14mm). Do not tighten.

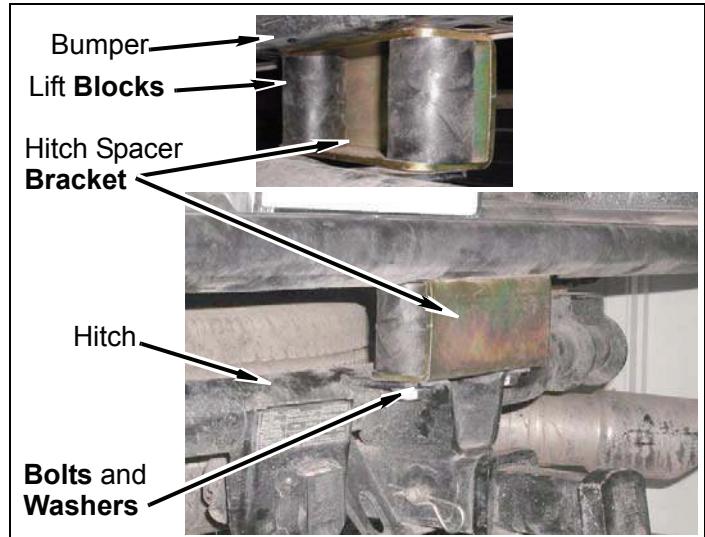

- p. Install hitch on frame with two short bolts and nuts. Use forward most hole in hitch.

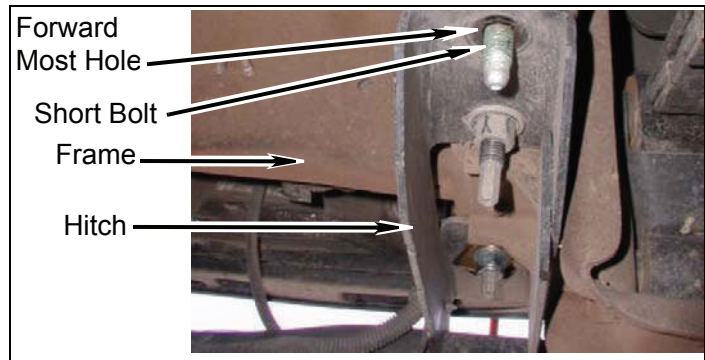

- q. Install kit **brackets** (rear bumper) and hitch on frame with two long bolts, two kit **washers** (1-1/2 x 2-1/2 rectangular), two kit **washers** (14mm), into two kit **nuts** (14mm nylock).

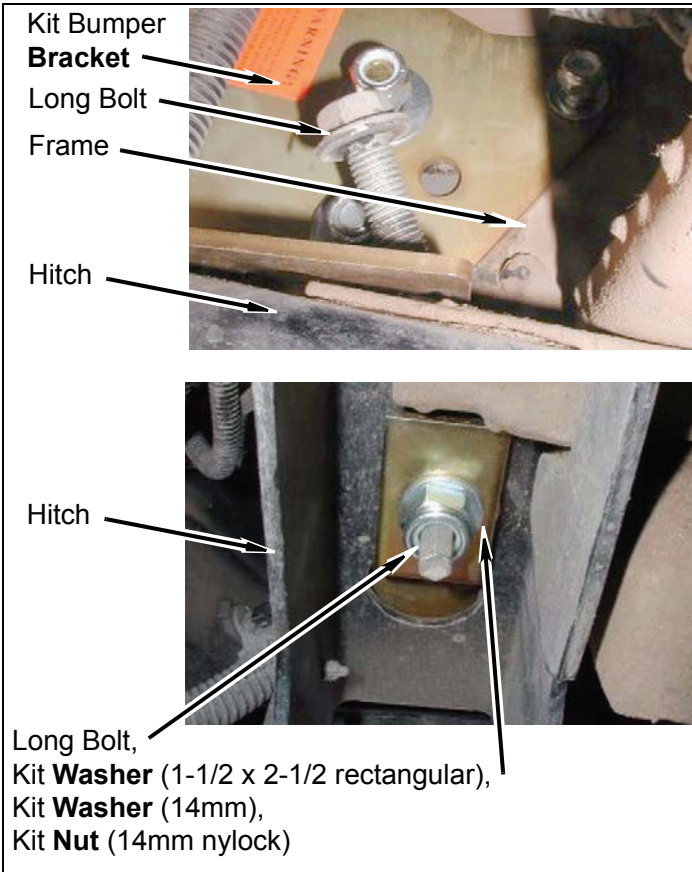

- r. Adjust bumper to bed clearance using measurements taken earlier and tighten hitch bolts first then remaining bolts and nuts to 55 lb-ft.
- s. Plug license plate light harness in at crossmember connector.

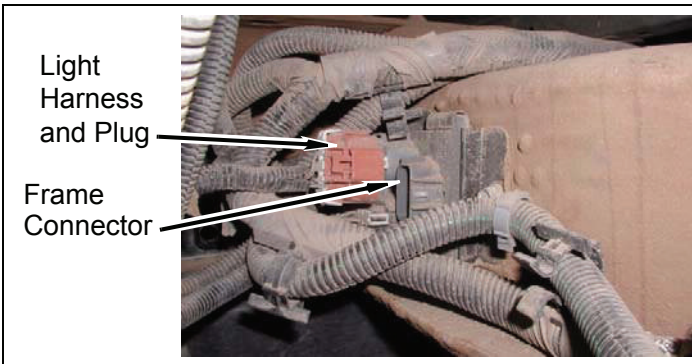

2. Fuel filler

⚠WARNING
 Use extreme caution when working near fuel lines and fuel tank. Clean up spilled fuel immediately. Any spark could cause an explosion or fire resulting in serious personal injury and property damage.

- a. Remove vent hose from clamp and fuel filler neck.

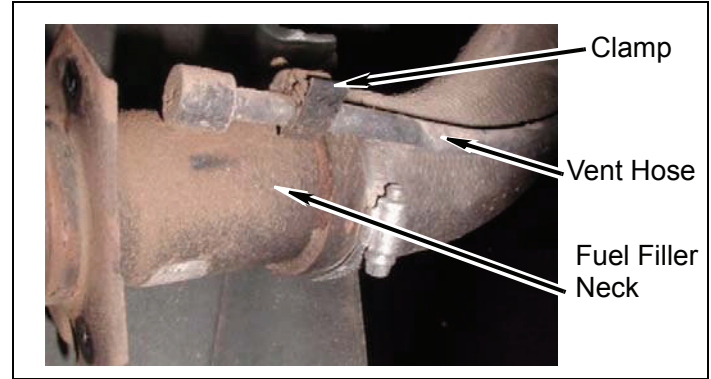

- b. Remove hose clamp and filler hose from fuel tank. Ground wire can be left attached to fuel filler neck.

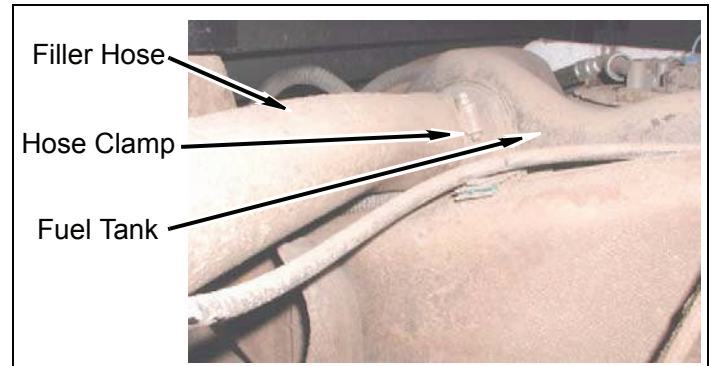

- c. Carefully cut filler hose where shown. ENSURE YOU DO NOT CUT THROUGH PLASTIC VENT TUBE INSIDE FILLER HOSE.

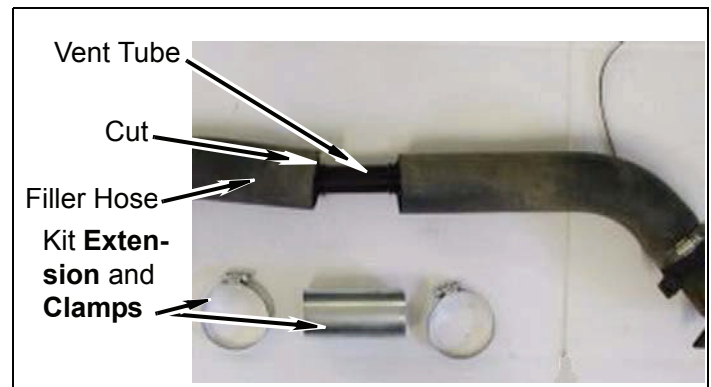

- d. Install kit **extension**, **fuel filler** in filler hose with two kit **clamps** (#36).

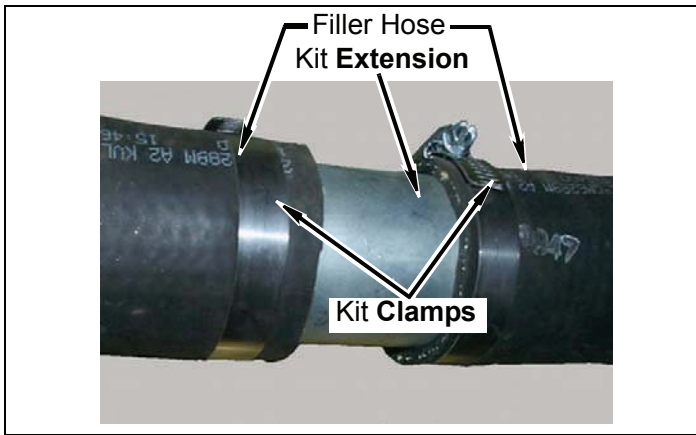

- e. Install filler hose on fuel tank with clamp.

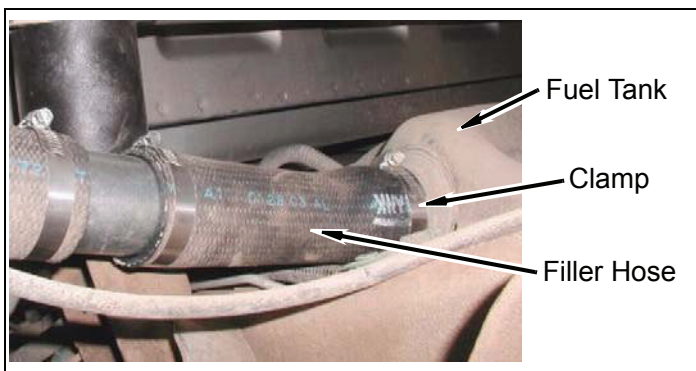

- f. Install vent tube in clamp.

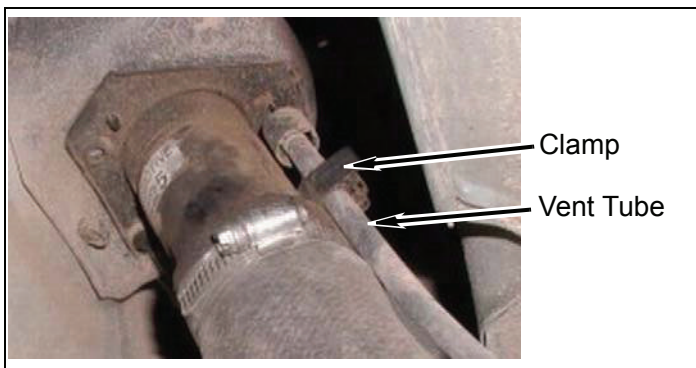

- g. Install fuel filler on the bed with three bolts. Install fuel cap.

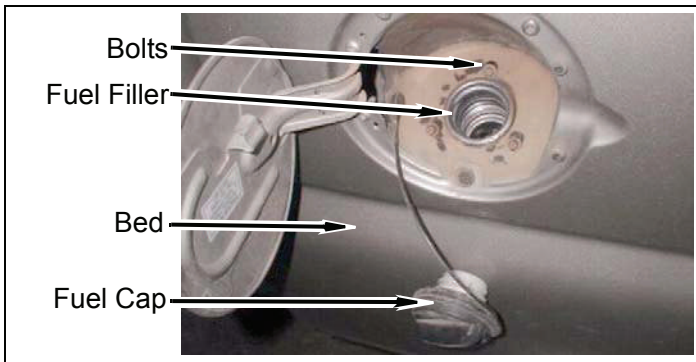

D. Frame

- 1. Safety cables, single cab only

- a. Install two kit **brackets**, safety cable extension on frame rear mounting pads with two bolts.
- b. Install two safety cables on kit **brackets**, safety cable extension with two kit **bolts** (3/8" x 1 1/2"), four kit **washers** (3/8" USS), and two **nuts** (3/8" nylock).

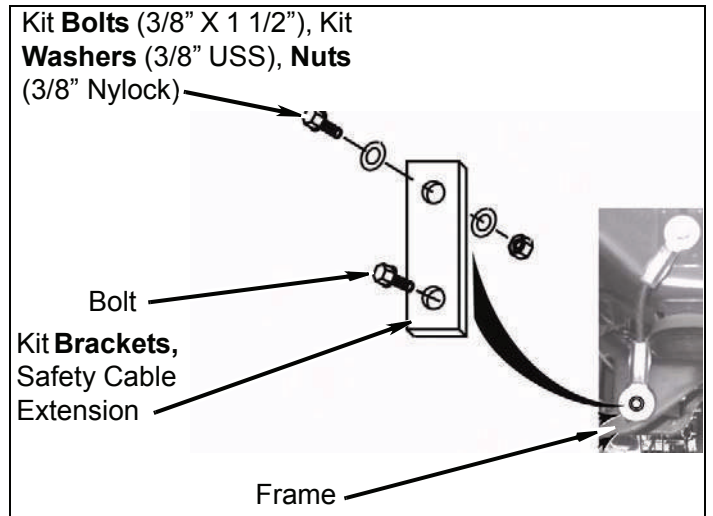

- 2. Parking brake cable.

NOTE

Some filing of drilled 1/2" hole may be required to allow parking brake cable housing to fit properly.

- a. Drill a 1/2" hole in the frame 2" up and 1/2" over from original hole as shown.

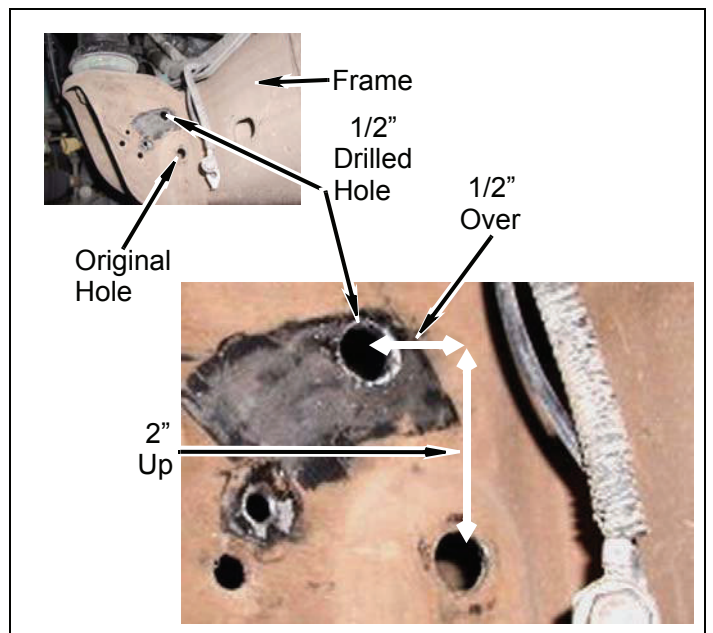

- b. Bend tab on front of frame mounting pad up as shown.

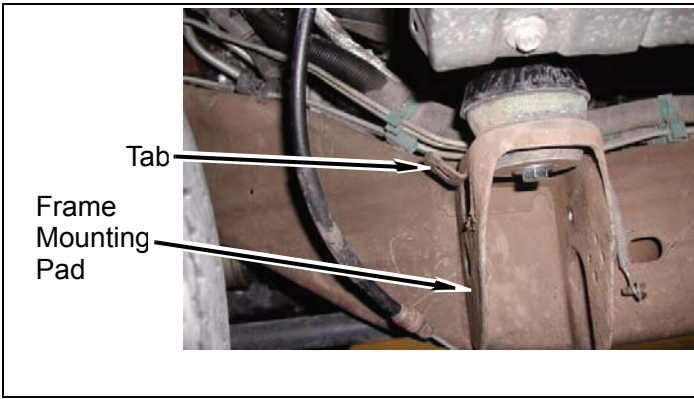

- c. Install the front parking brake cable housing as shown.

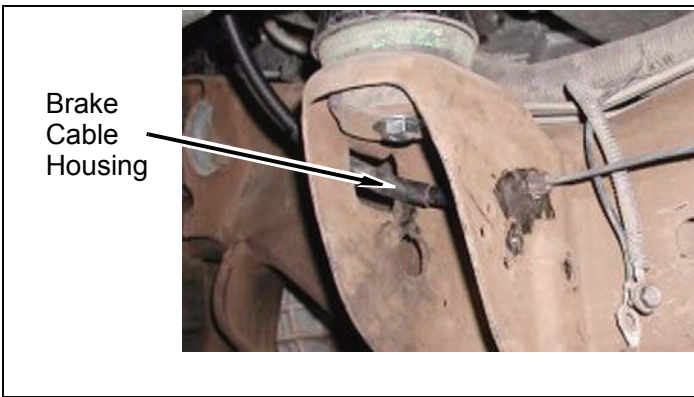

- d. Install two ground wires on frame mounting pad with bolt. Connect front and rear brake cables. Remove clamps from rear cable.

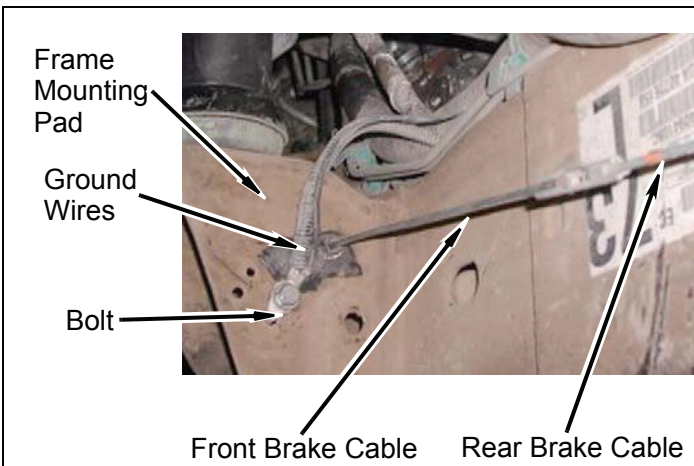

NOTE

The following step is for vehicles with manual transfer case only. Other models skip this step.

- 3. Lengthen and install transfer case shift lever.
 - a. Remove two spring clips and transfer case linkage from shift lever, transfer case shift arm.

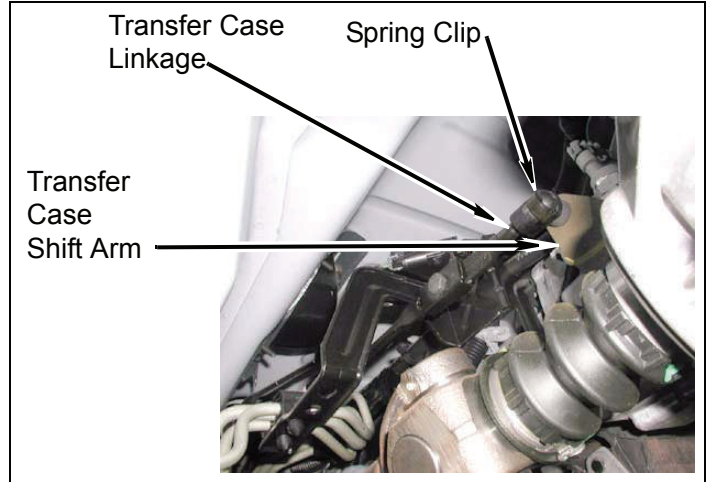

- b. Scribe a line along transfer case linkage as shown. Cut transfer case linkage into two pieces through the scribed line and deburr.

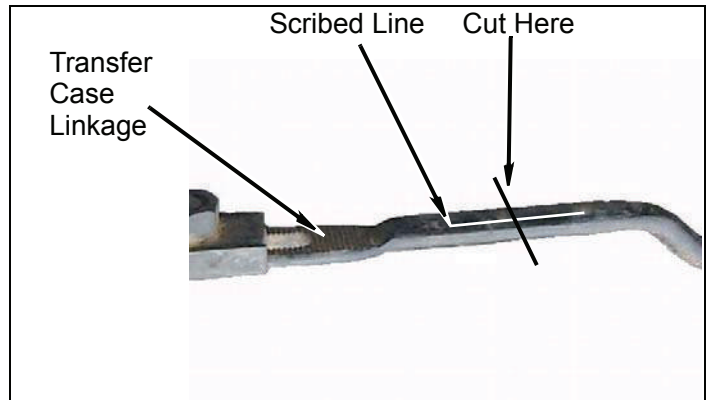

WARNING

A certified welder should perform all welding.

- c. Position kit **pin** 4x4 extension between two pieces of transfer case linkage. Ensure transfer case linkage scribed lines align and weld kit **pin** extension in place.

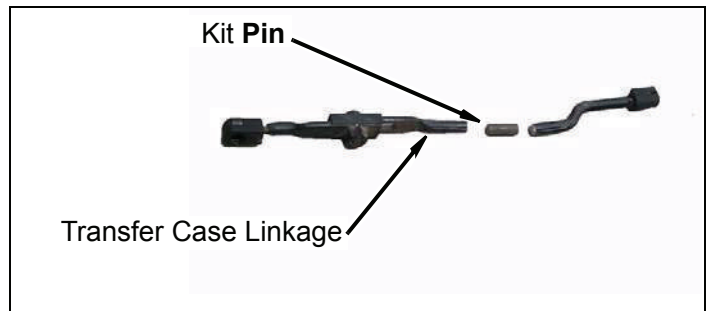

- d. Install transfer case linkage on transfer case shift arm and shift lever with two clips.
- e. Check transfer case shift lever operation. Ensure there is complete engagement in all ranges. If necessary, adjust the linkage.

4. **Manual transmission** shift lever.

NOTE

Manual transmissions require shift extension SE4701 **purchased separately**. Automatic transmission models skip this step.

5. Driver side wheel well and frame rail.

- a. Install kit **bracket**, s-shaped on frame with bolt.
- b. Install power steering hose and clamp on kit **bracket**, s-shaped with a kit **washer** (1/4" SAE) and a kit **nut** (1/4" nylock).

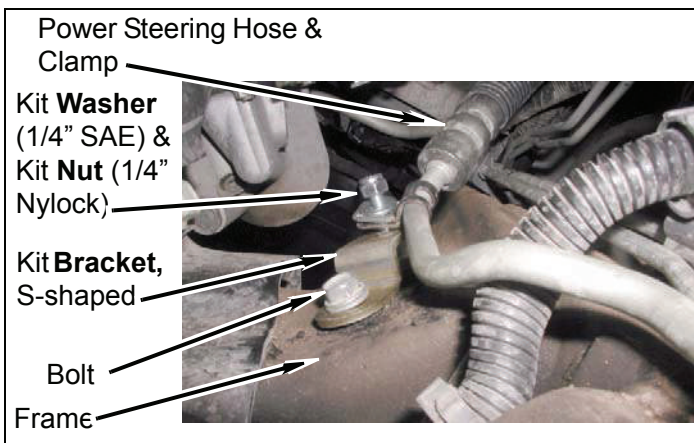

- c. If possible, install four harness clips on frame and wheel well.

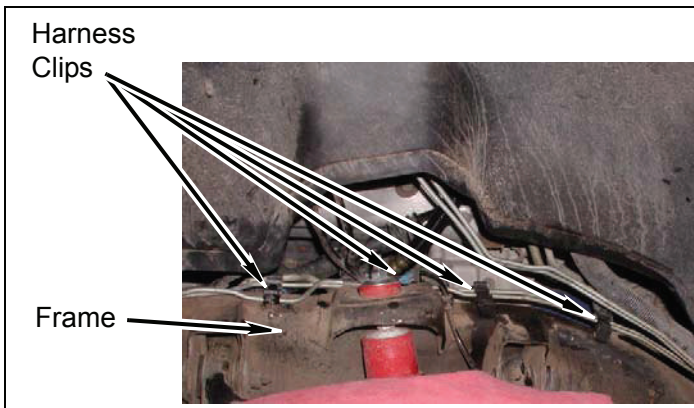

- d. If possible, install two brake lines in two sets of clips. If brake lines will not fit back into position, wrap lines with two kit **zip ties** individually, and then secure the lines together with one kit **zip tie** as a bundle.

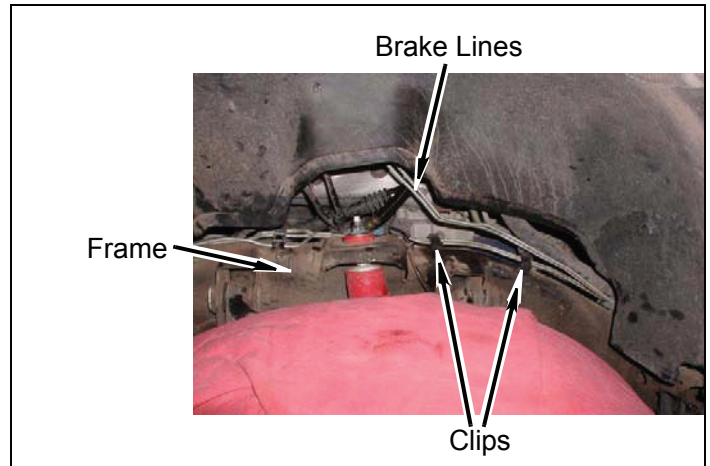

- e. If possible, install harness in clip on frame driver side.

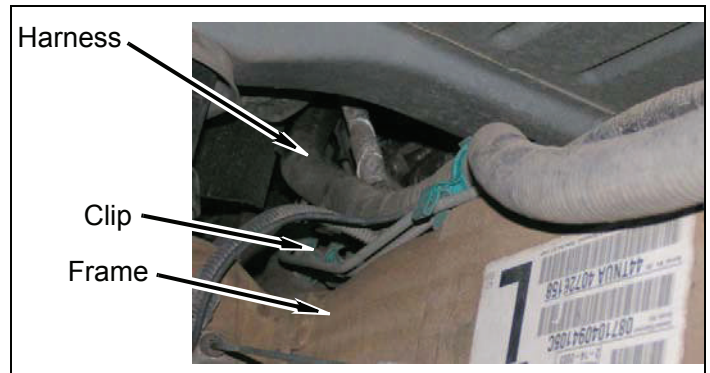

E. Engine Compartment

1. Heater hose

- a. Position and trim kit **hose**, heater 5/8 x14" as necessary, to eliminate any kinks. Tighten kit **hose clamps**.

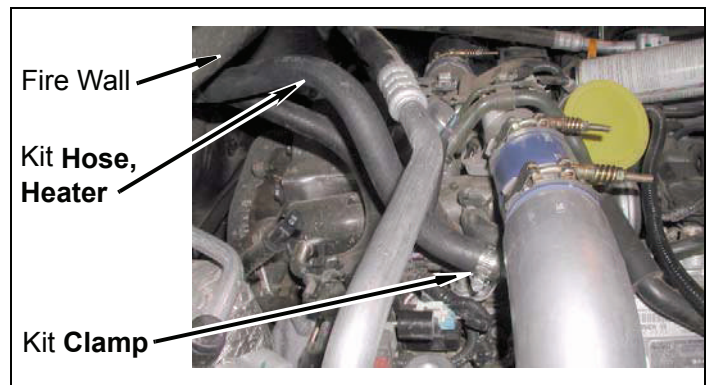

2. Intercooler piping passenger side

- a. Install silicone hose and intercooler piping on turbo outlet with two clamps. Do not tighten.

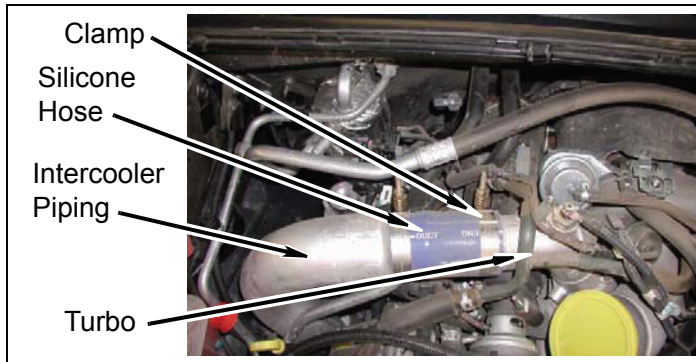

- b. Modify intercooler lower silicone hose.
3" lift kit; Cut silicon hose 2" from duct end as shown.
2" lift kit; Cut silicon hose 1 1/4" from duct end as shown.

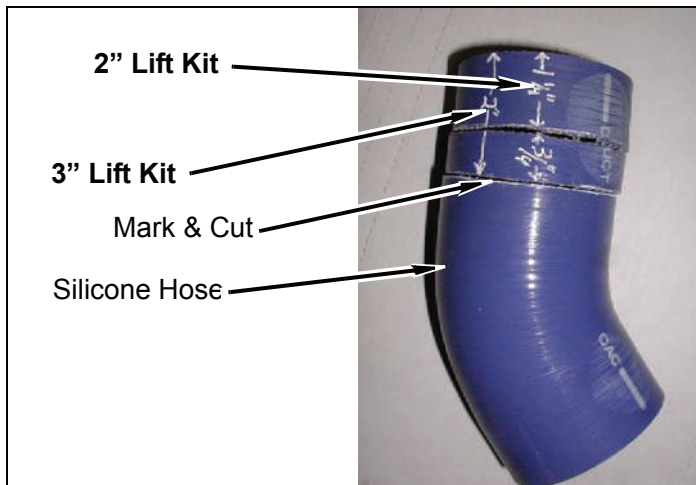

- c. Install silicone elbow on intercooler inlet and intercooler piping with two clamps.

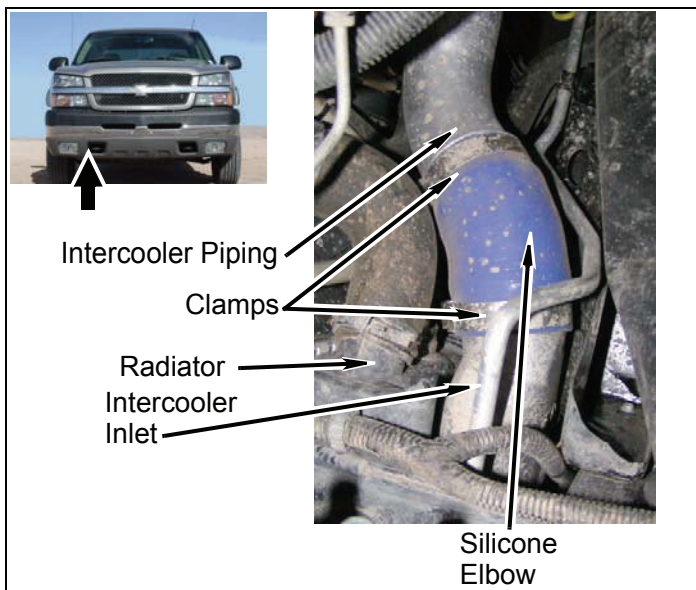

- d. Install harness on coolant hose with kit zip-tie as shown.

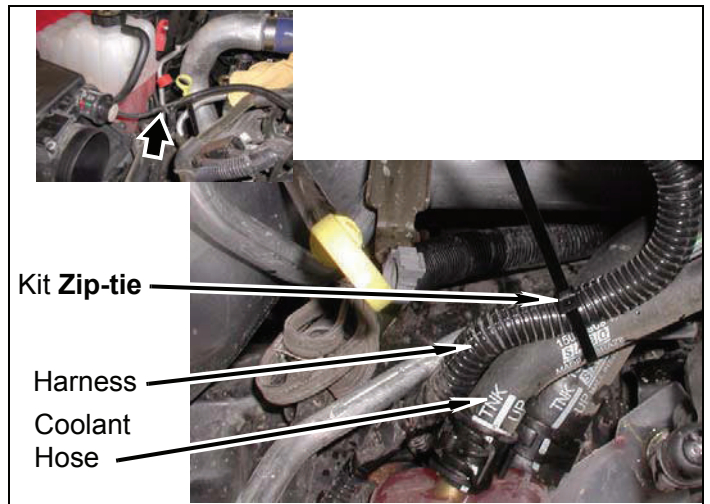

3. Intercooler piping drive side

- a. Position silicone elbow on intercooler and air pipe with two clamps.

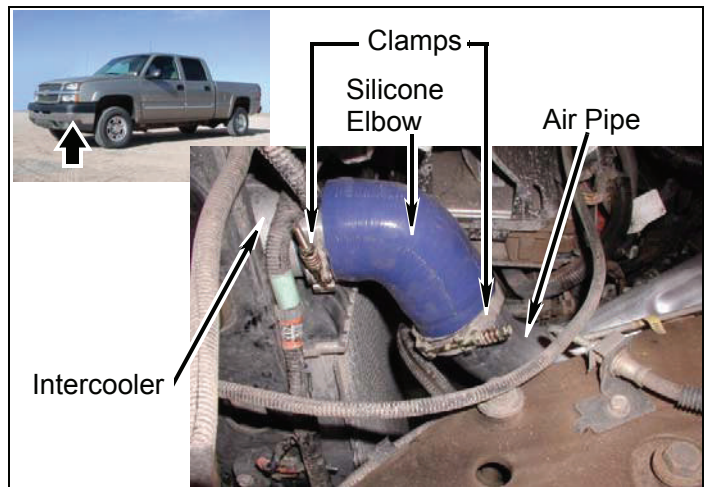

4. Wiring harnesses and ground strap

- a. If possible, install clip in bracket (top of engine).

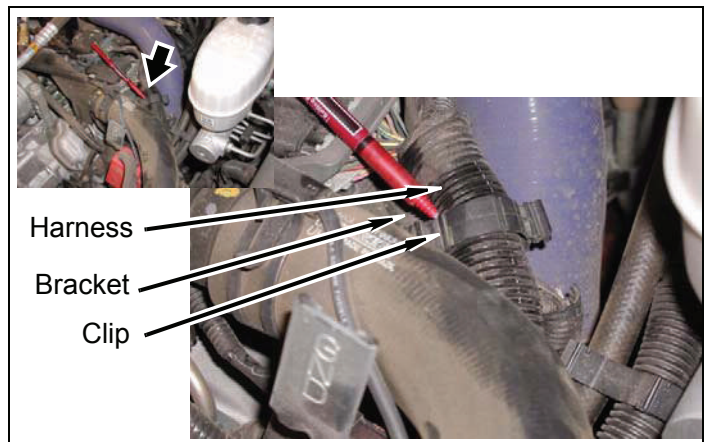

b. Install ground strap on stud with nut.

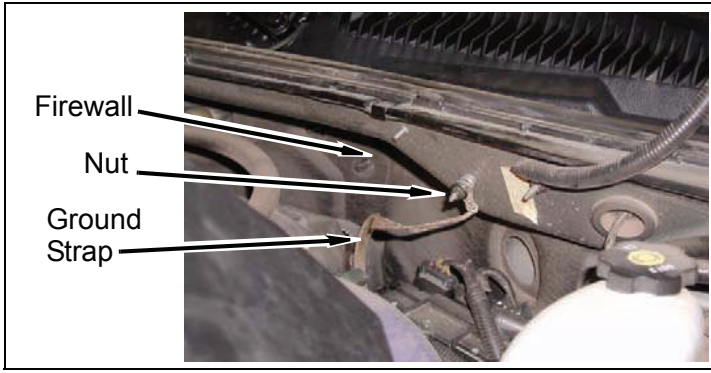

b. Trim tabs from edges of lower fan shroud as shown.

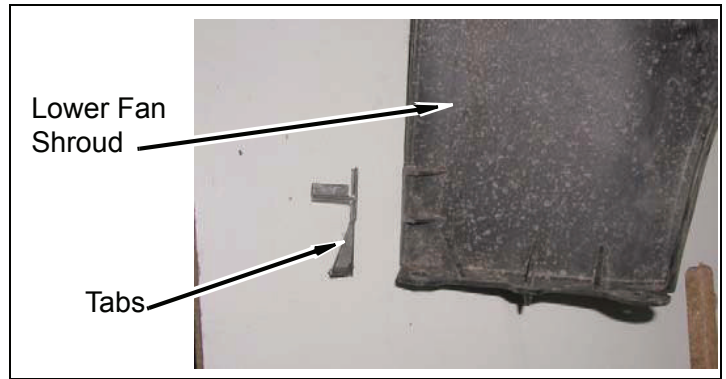

5. Install kit steering extension.

- a. Place a few drops of kit Loctite® on threads of bolts for both following steps.
- b. Install kit **steering extension** on upper steering shaft with kit **bolt** (3/8" x 1 3/4"), two kit **washers** (3/8" SAE), and kit **nut** (3/8" nylock). Do not tighten.
- c. Install kit **steering extension** into lower steering shaft with bolt and nut. Tighten bolt to 33 lb-ft.

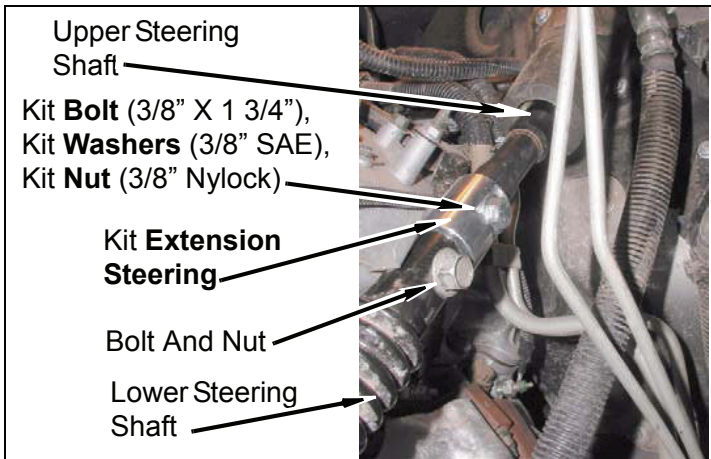

c. Cut lower fan shroud off a long marked corner.

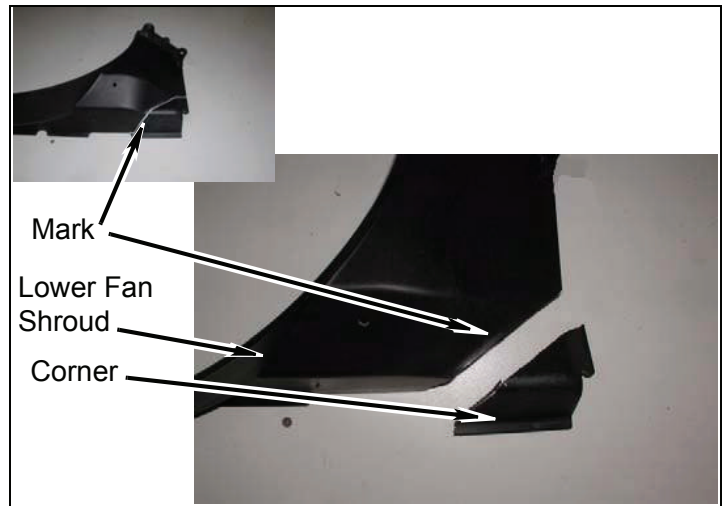

7. Upper fan shroud.

a. Trim upper fan shroud according to cuts made on lower fan shroud, marked as shown.

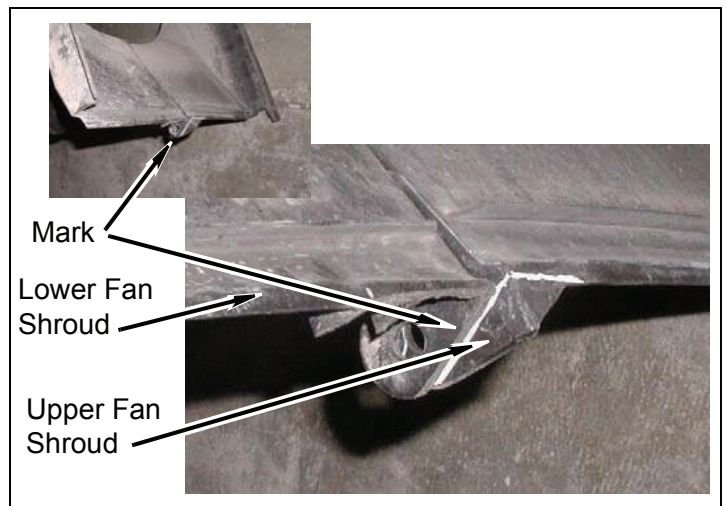

6. Lower fan shroud.

a. Carefully slide lower fan shroud down under core support and remove from vehicle.

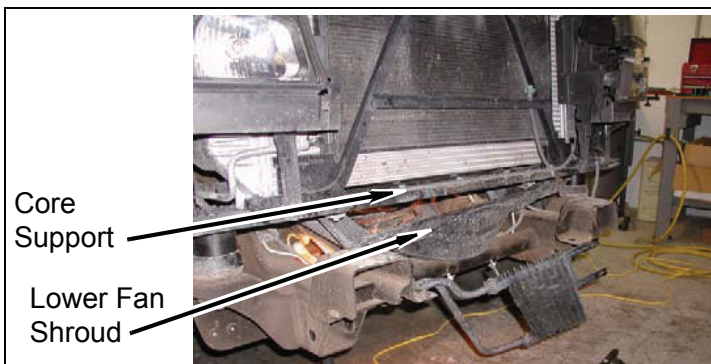

- b. Measure upper fan shroud from top down 1-1/2". Mark and cut upper fan shroud as shown.

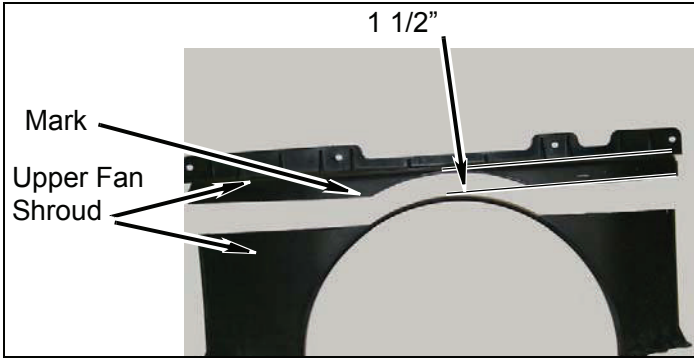

- c. Clamp fan shroud on table top as shown.
- d. Position kit **bracket, upper fan shroud** (center) on fan shroud with two tabs under and edges over shroud as shown.

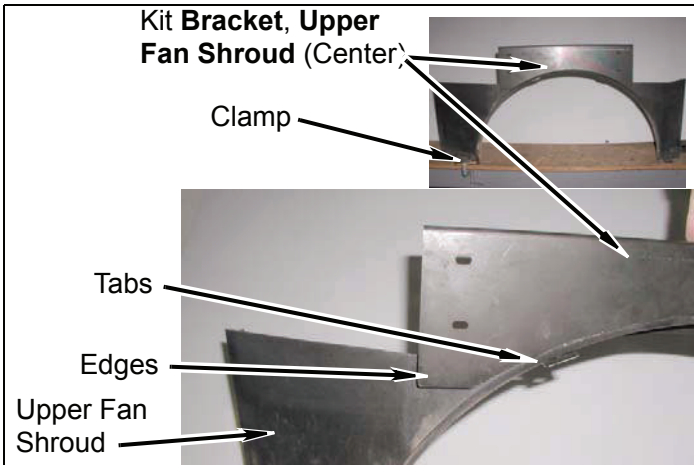

- e. Assemble three kit **brackets, upper fan shroud** (left, center, and right) with two kit **bolts** (1/4" x 3/4"), four kit **washers** (1/4" SAE), and two kit **nuts** (1/4" nylock) as shown. Snug, bolts but do not tighten.
- f. Measure kit **bracket, upper fan shroud** (center) from table top as shown. Ensure bracket is level.

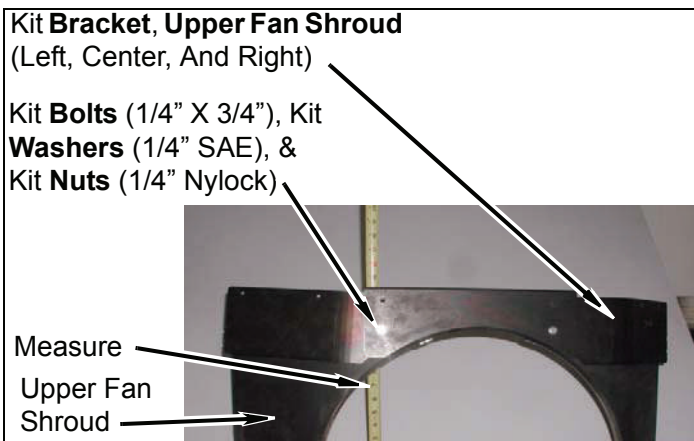

NOTE

The two kit **brackets, upper fan shroud** (left and right) come with two notches on the outer edges. these notches represent two and three inch kits. Position the notches according to your kit.

- g. Clamp two scrap pieces of metal (or rullers) to fan shroud as shown. Position upper fan shroud on metal scrap and under kit **bracket, upper fan shroud** (center).

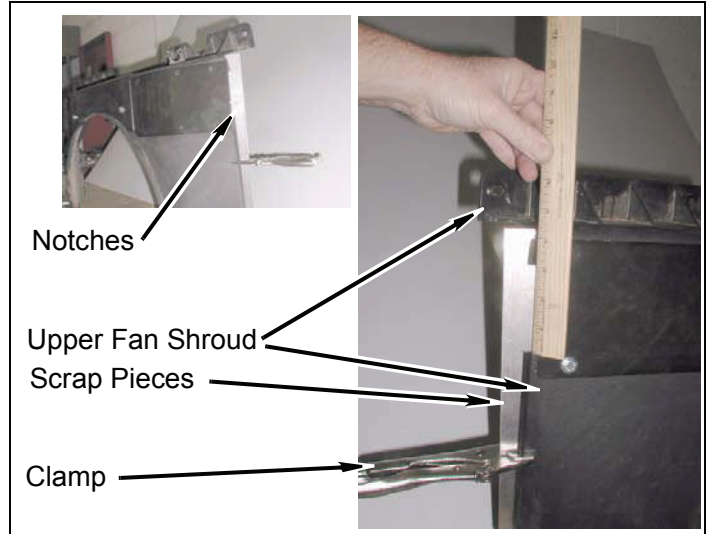

- h. Using three kit **brackets, upper fan shroud** (left, center, and right) as templates, drill 1/4" holes in fan shroud.
- i. Install three kit **brackets, upper fan shroud** (left, center, and right) on upper fan shroud with four kit **clips push**, ten kit **bolts** (1/4" x 3/4"), twenty kit **washers** (1/4" SAE), and ten kit **nuts** (1/4" Nylock).

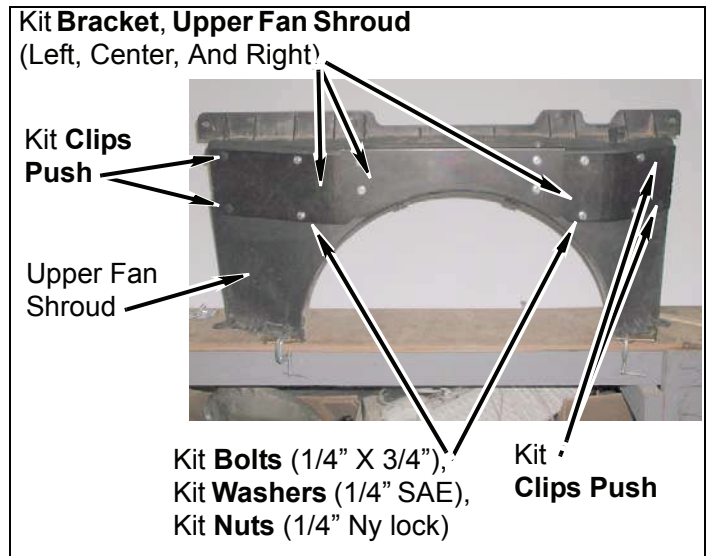

- j. Using kit **bracket, upper fan shroud** (center) as template, drill two 1/4" holes in fan shroud lip. Install kit **bracket, upper fan shroud** (center) on upper fan shroud lip with two kit **clips push**.

8. Lower fan shroud

- a. Remove four center harness clips from core support. Remove four clips from harness.

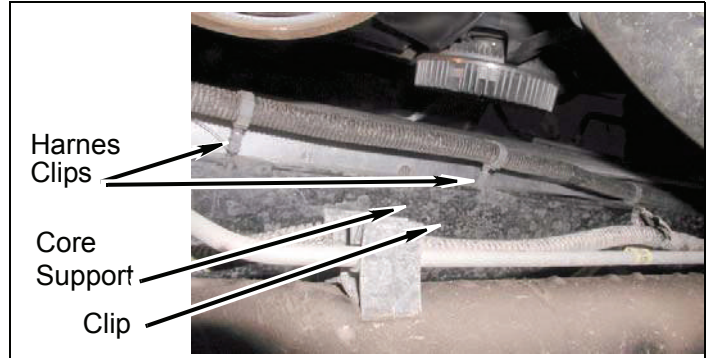
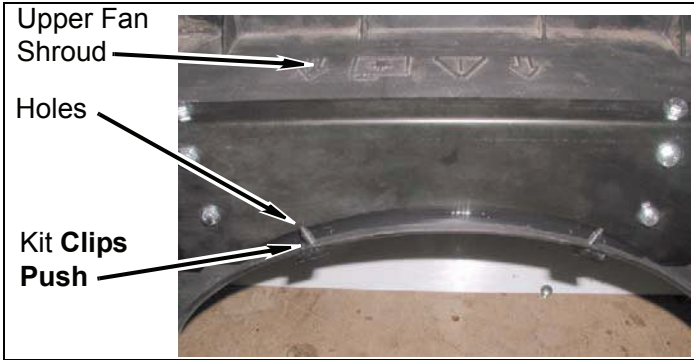

- k. If applicable, position computer cover on upper fan shroud assembly as shown. Position kit **bracket, support** on computer cover as shown. Using kit **bracket, support** as a template, mark and drill two 1/4" holes as shown.

- b. Position two kit **loom clamps** on harness.

NOTE
Kit bracket, lower fan shroud support lip should face down and under the lower fan shroud. The *lip* points toward the engine.

- l. If applicable, install kit **bracket, support** on fan shroud assembly with two kit **bolts** (1/4" x 3/4"), four kit **washers** (1/4" SAE), and two kit **nuts** (1/4" nylock). Ensure kit **bolts** point away from the radiator as shown.

- c. Install two kit **loom clamps** and kit **bracket, lower fan shroud support** (assembly) on core support with four kit **bolts** (1/4" x 3/4"), kit **washers** (1/4" SAE), and kit **nuts** (1/4" nylock). Snug bolts, but do not tighten.

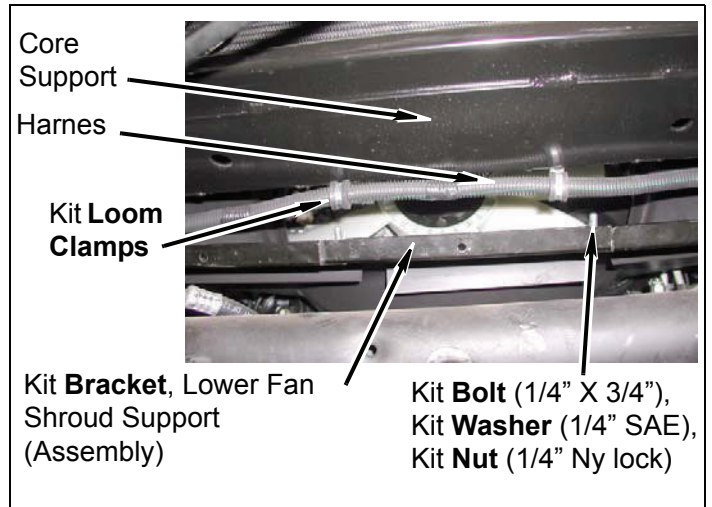
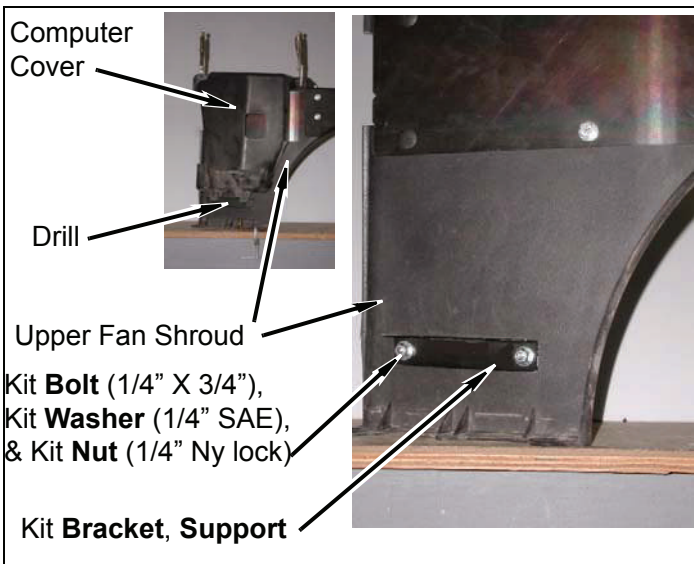

d. Position bottom fan shroud in vehicle and rest below lower fan shroud mounting brackets.

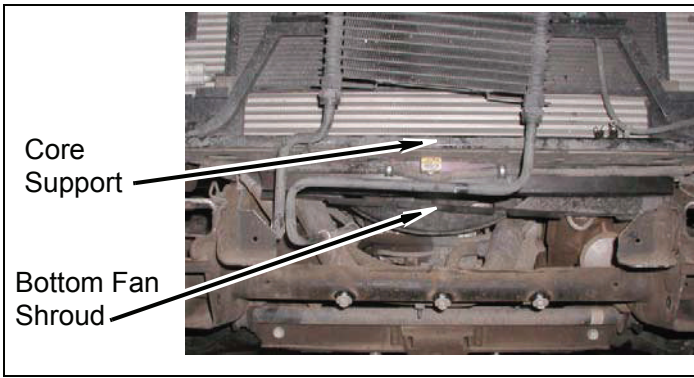

e. Install top fan shroud assembly, computer, and computer cover on core support with four bolts. Do not tighten.

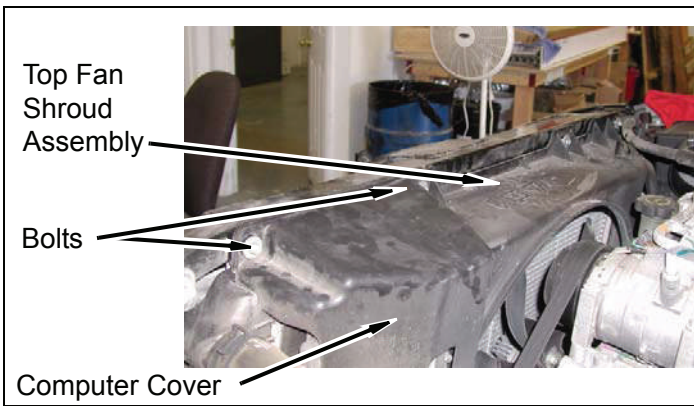

f. Install two kit washers (1/2" USS) as spacers inbetween upper fan shroud and computer cover as shown.

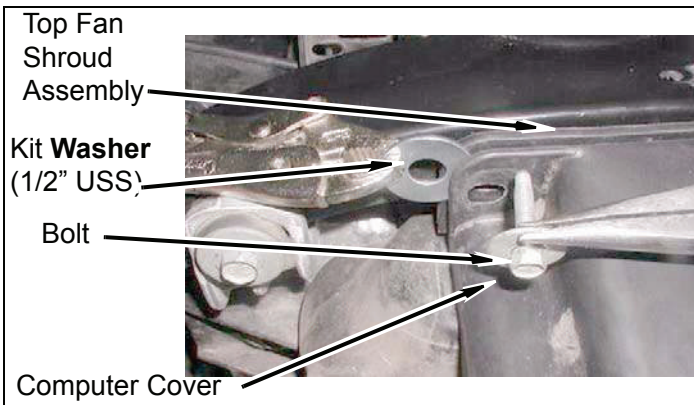

g. Install top fan shroud on bottom fan shroud with four pop-ups. Check fan to shroud clearance. Ensure gap is the same all around shroud.

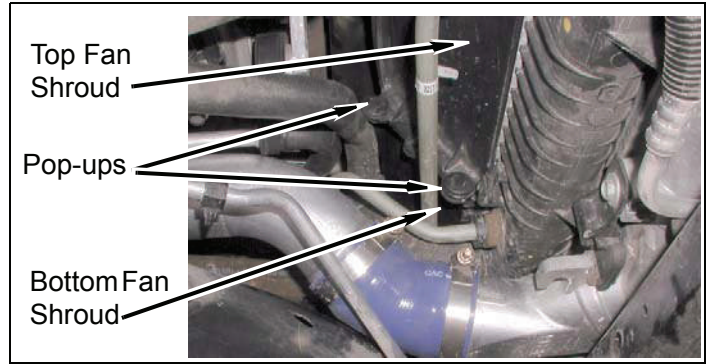

h. Using kit brackets, lower fan shroud support as a template, mark lower fan shroud hole locations as shown. Remove four pop-ups from upper fan shroud and lower fan shroud. Remove lower fan shroud from vehicle.

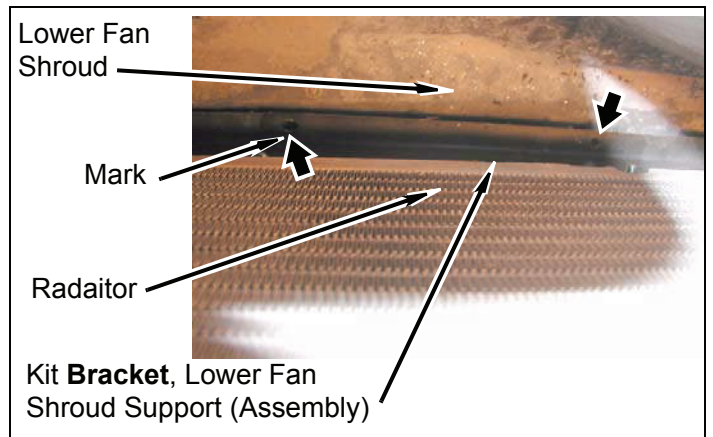

i. Remove four kit bolts (1/4" x 1"), kit washers (1/4" SAE), kit nuts (1/4" nylock), and kit bracket, lower fan shroud support (assembly) from the core support.

j. Drill lower fan shroud where marked.

k. Install kit cover lower fan shroud on kit bracket, lower fan shroud support (right) with two kit clips, push.

- l. Install kit **cover** lower fan shroud and kit **bracket**, lower fan shroud support (right) on lower fan shroud with kit **bolt**, (1/4" x 3/4"), two kit **washers** (1/4" SAE), and kit **nut** (1/4" nylock) as shown.

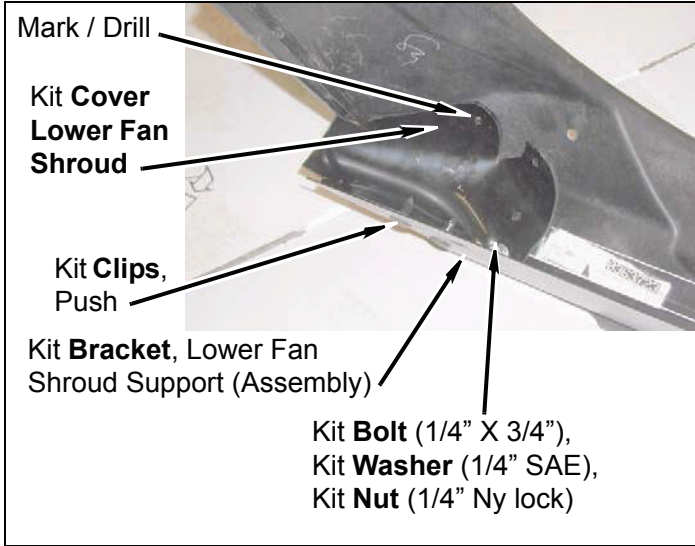

- m. Using kit **cover** lower fan shroud as a template drill three 1/4" holes in lower fan shroud.

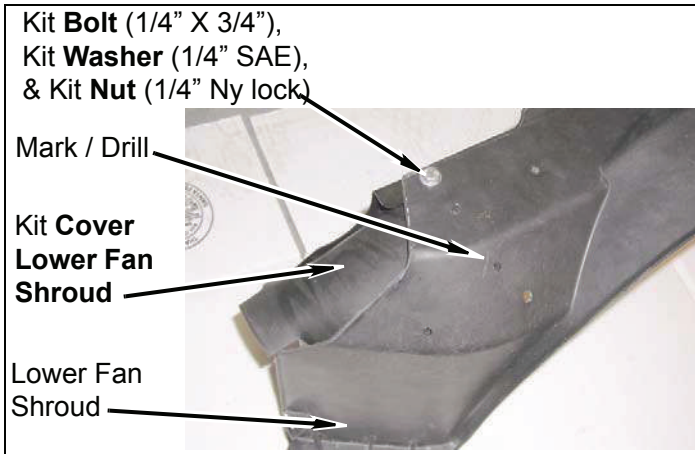

- n. Remove kit **bracket**, lower fan shroud support (assembly) from lower fan shroud.

- o. Install kit **bracket**, lower fan shroud support (assembly) on core support with four kit **bolts** (1/4" x 3/4"), kit **washers** (1/4" SAE), and kit **nuts** (1/4" nylock). Snug bolts, but do not tighten.

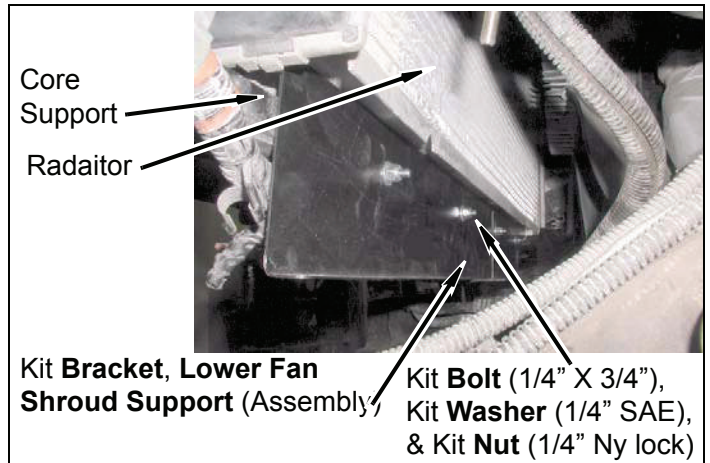

- p. Install lower fan shroud on kit **bracket**, lower fan shroud support (assembly) with two kit **bolts**, (1/4" x 3/4"), four kit **washers** (1/4" SAE), and two kit **nuts** (1/4" nylock). Ensure bolt threads point out of shroud.

- q. Install three kit **clips, push** on kit **cover**, lower fan shroud and lower fan shroud.

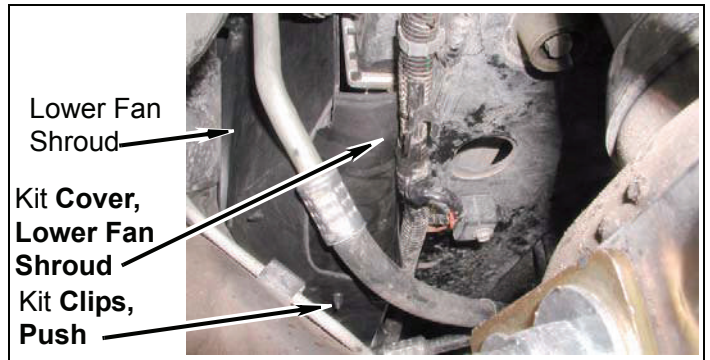

- r. Install top fan shroud on bottom fan shroud with four pop-ups. Check fan to fan shroud clearance. Ensure gap is the same all around shroud and tighten bolts and nuts.

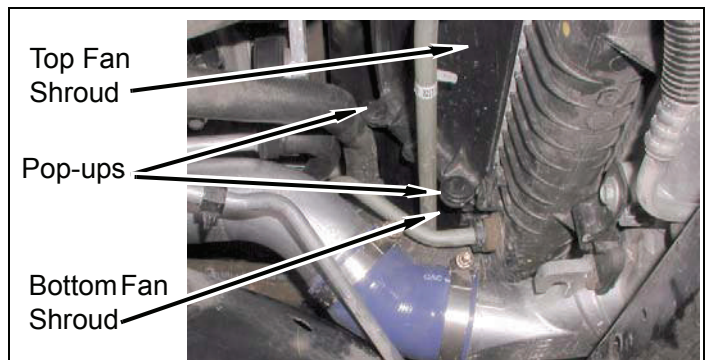

9. Air intake

- a. Position air duct on air filter housing and turbo-charger, tighten two clamps.

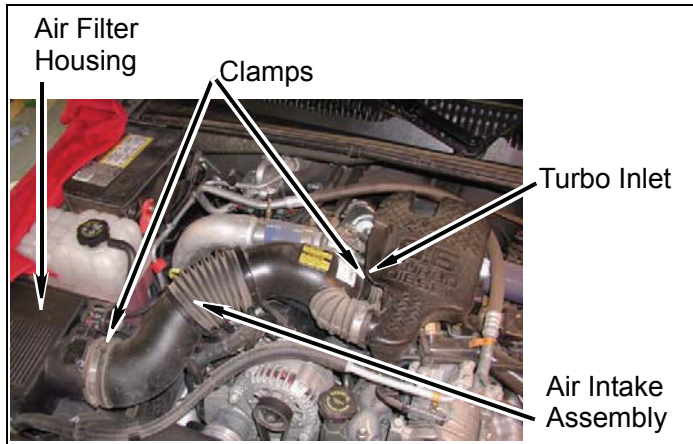

- b. Install air baffle and air intake assembly on engine with clamp and torx bolt

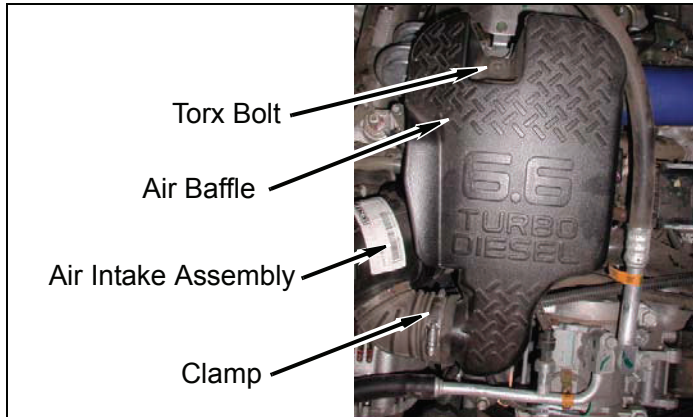

F. Front of vehicle

1. Transmission cooler (If so equipped)

- a. Remove two nut clips from transmission cooler and install in holes on core support A-frame.

- b. Install two kit **brackets** s-shaped on two clip nuts on core support A-frame with two bolts. Do not tighten.

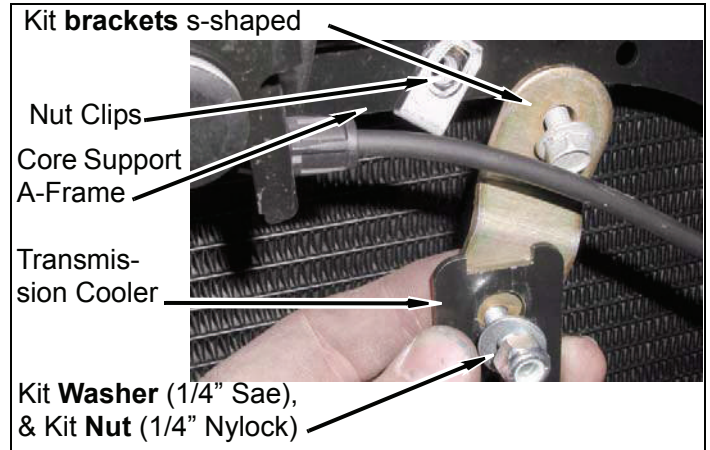

- c. Install transmission cooler on two kit **brackets** s-shaped with two kit **washers** (1/4" SAE) and kit nylock **nuts** (1/4"). Do not tighten.

- d. Install transmission cooler on core support A-frame with two kit **spacer tubes**, two kit **bolts** (1/4" x 3"), four kit **washers** (1/4" SAE), and two kit **nuts** (1/4" nylock). Tighten nuts and bolts.

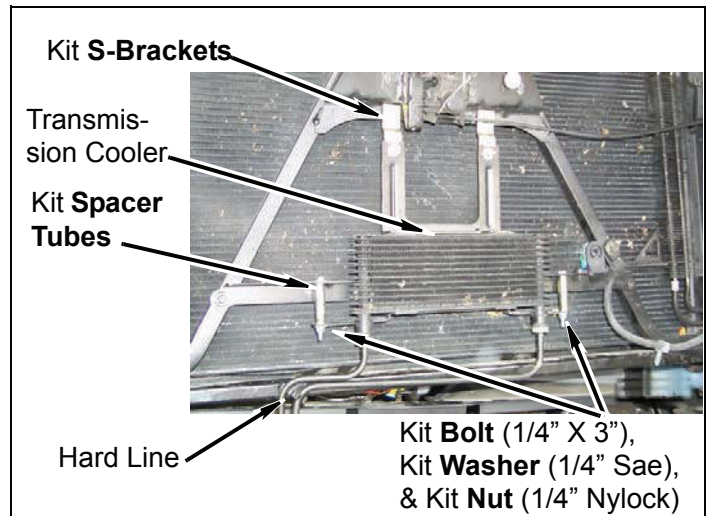

- e. If necessary, carefully bend hard line and secure with kit **zip tie**.

2. Plastic splash guard and air flap

- a. Install air flap on core support with three push clips and two clips.

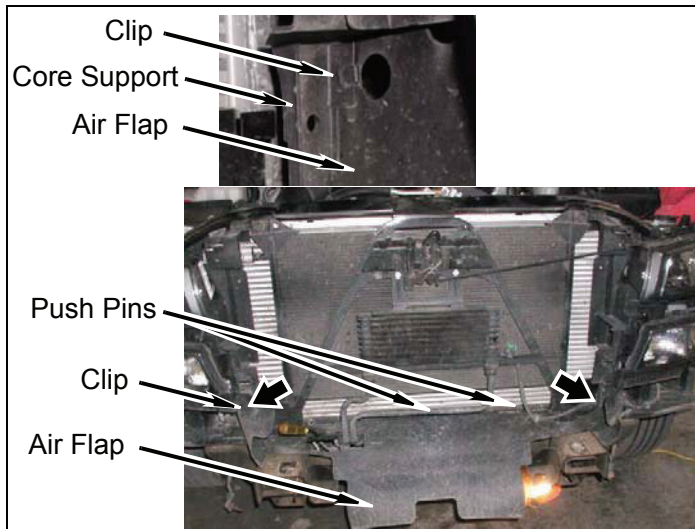

- b. If removed, install clip and harness on air flap.

- c. Install plastic cover on frame and core support with five bolts.

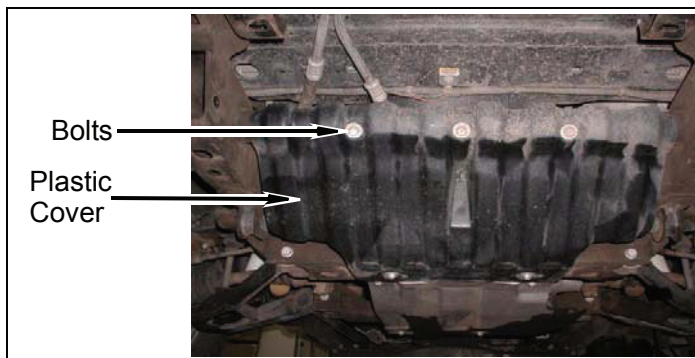

3. Install front bumper

- a. Place a few drops of kit Loctite® on threads of bolts.

⚠NOTE

Following steps are for 3" kit.

- b. **3" kit:** Install two kit **brackets L-shaped** on two kit bumper **brackets** with four kit bolts (7/16" x 1 1/2"), eight kit **washers** (7/16" USS), and four kit **nuts** (7/16" nylock). Do not tighten.

- c. **3" kit:** Install kit **brackets bumper** on frame with two bolts, two kit **bolts** (7/16" x 1 1/2"), four kit **washers** (7/16" USS), and two kit **nuts** (7/16" nylock) . Do not tighten.

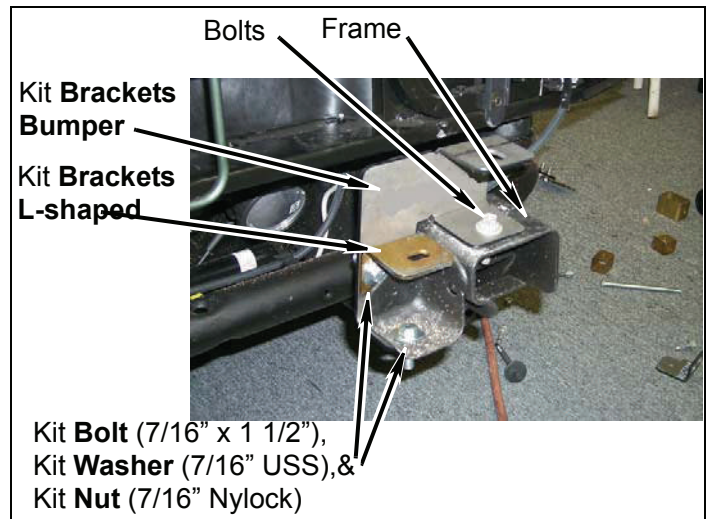

- d. **2" kit:** Install two kit **brackets bumper** and two kit **brackets C-shaped** on frame with two stock bolts, two kit **bolts** (7/16" x 1 1/2"), four kit **washers** (7/16" USS), and two kit **nuts** (7/16" nylock). Do not tighten.

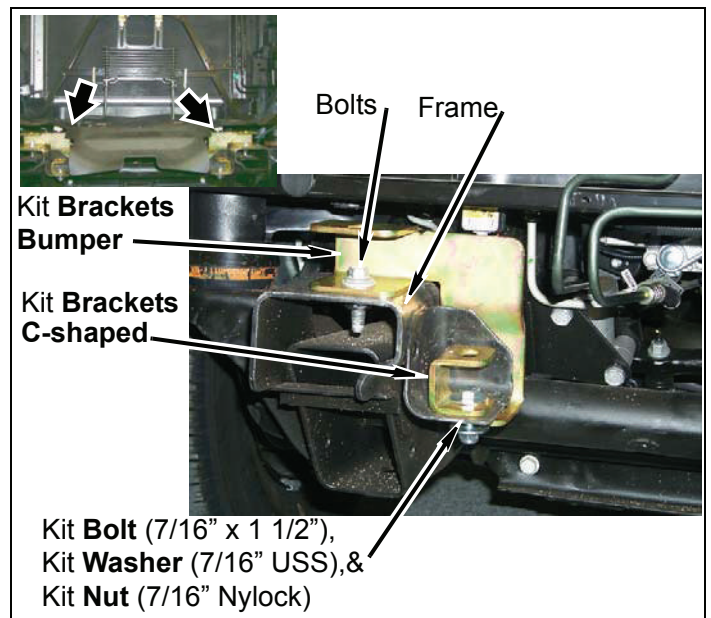

e. **2003-2004 models:** Mark and cut two front bumper brackets. Bend bottom edge of bumper bracket up toward bumper.

f. **2005 GMC models:** Mark and cut driver side front bumper as shown.

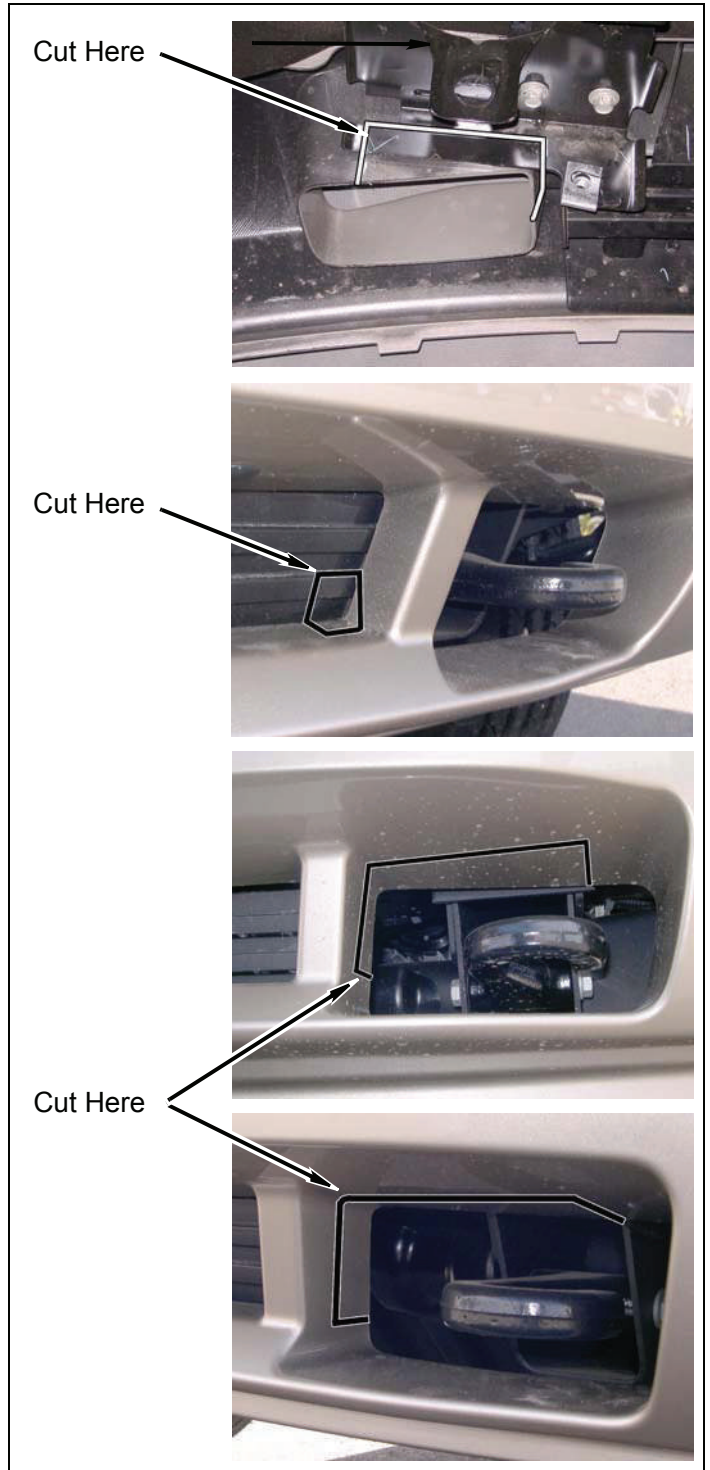
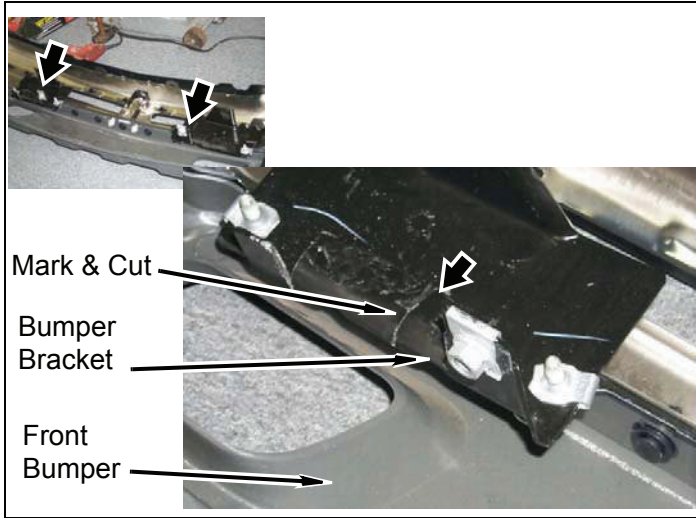

- g. **2005 GMC models:** Repeat above step for passenger side front bumper. Check fitment and trim driver and passenger side, if necessary.

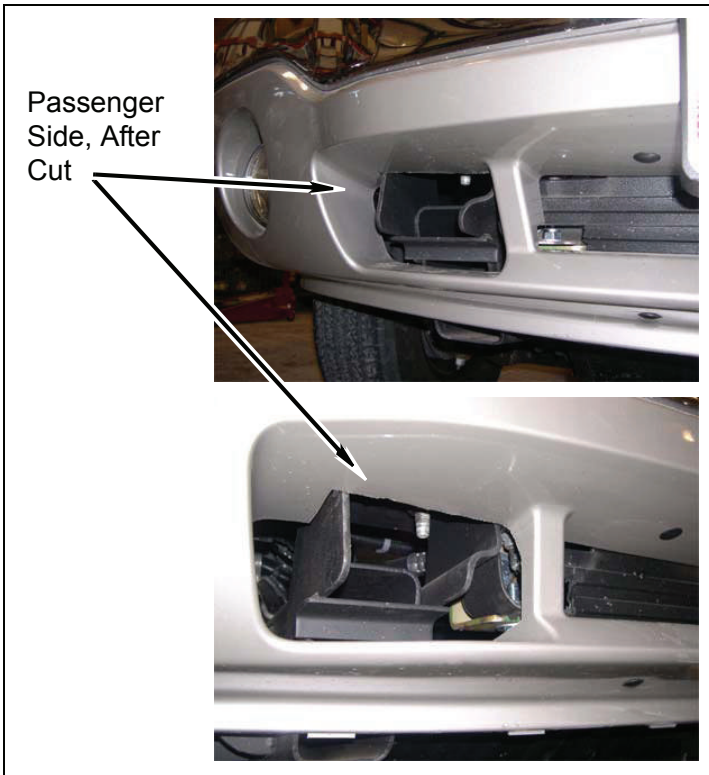

- h. Install front bumper on kit **brackets** bumper and with four kit **bolts** (7/16" x 1 1/2"), eight kit **washers** (7/16" USS), and four kit **nuts** (7/16" nylock). Do not tighten.

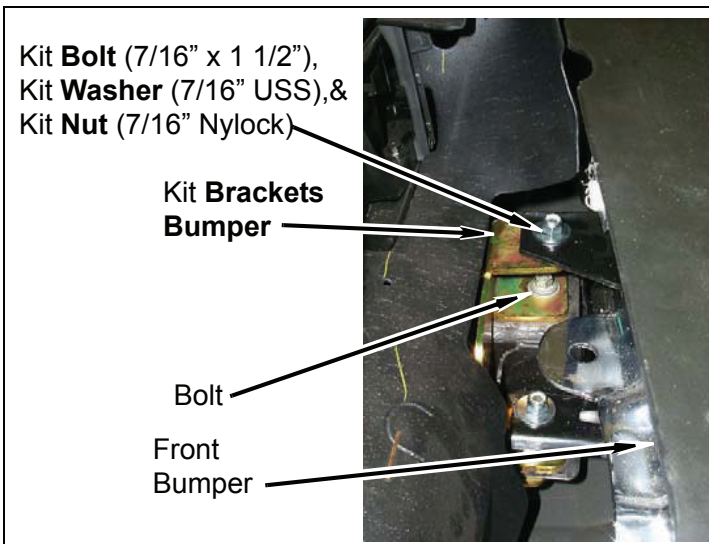

- i. **3" kit:** Position four kit **bolts** (7/16" x 1 1/2") and kit **washers** (7/16" USS) in side braces. Position top holes of kit **brackets** side brace over kit **bolts** and install four kit **washers** (7/16" USS) and kit **nuts** (7/16" nylock). Do not tighten.
- j. **3" kit:** Install two kit **brackets** side brace on frame with four bolts. Do not tighten.

- k. **3" kit:** Install two side braces on front bumper with two bolts.

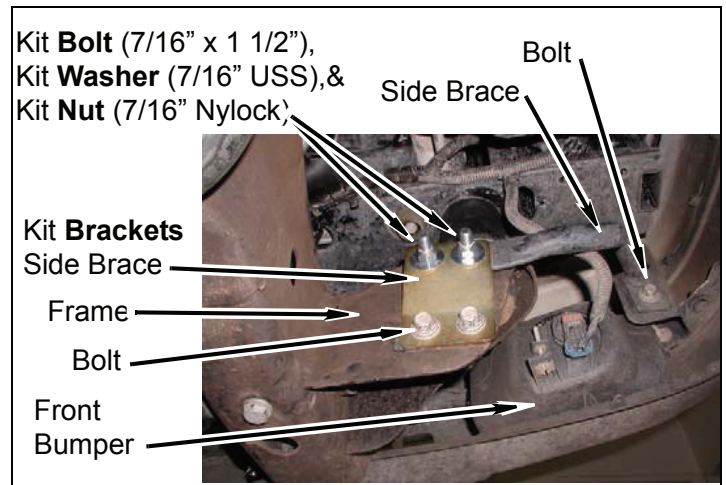

- l. **2" kit:** Install two side braces on front bumper with two bolts.
- m. **2" kit:** Using side braces as a template, drill four 1/2" holes in frame.
- n. **2" kit:** Install four kit **bolts** (7/16" x 1 1/2"), eight kit **washers** (7/16" USS), and four kit **nylock nuts** (7/16") in brackets and frame.

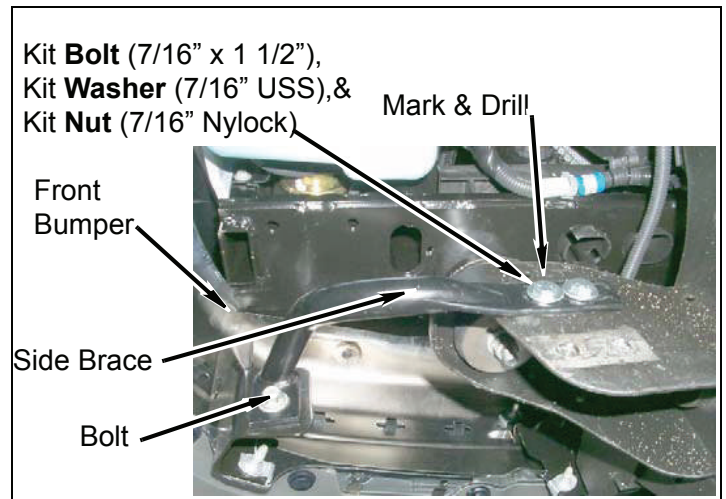

- o. Adjust bumper to body clearance using measurements from removal section.
- p. Tighten bolts and nuts to 55 lb-ft.

- q. If so equipped, install two connectors on two fog lamps.

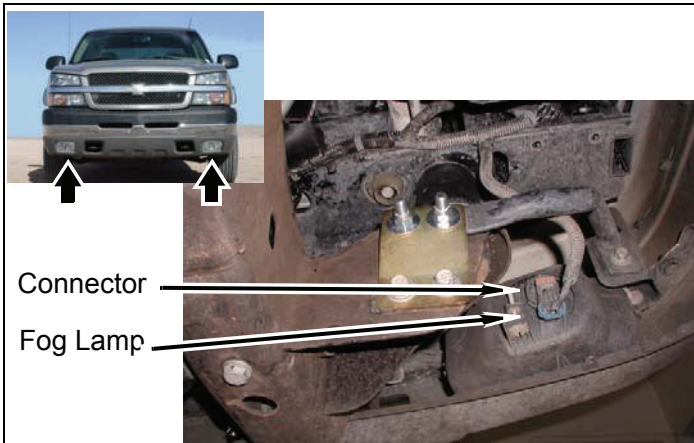

- b. Install four kit **crush blocks** on frame with four kit **washers** (5/16" USS) and four kit **screws** (5/16" x 3/4" self tapping).

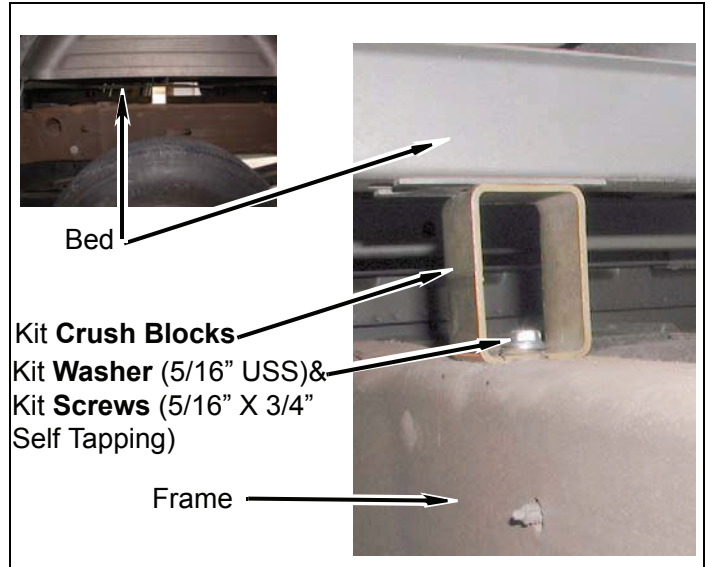

4. Install the grille

- a. Position grille on core support and install six clips in core support and front fenders.



- b. Install cover on core support with seven push pins.

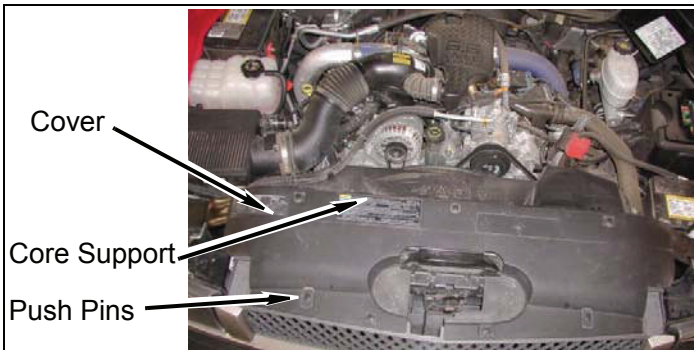

5. Install crush blocks

NOTE
Short wheel base trucks have two plastic disks and use two *kit* crush blocks.

- a. Remove four plastic disks from frame.

G. After installation is complete

1. Install airbag fuse in fuse panel. Install cover



2. Connect both battery cables to the battery. Be sure to reconnect the positive cables first, then the negative cables.

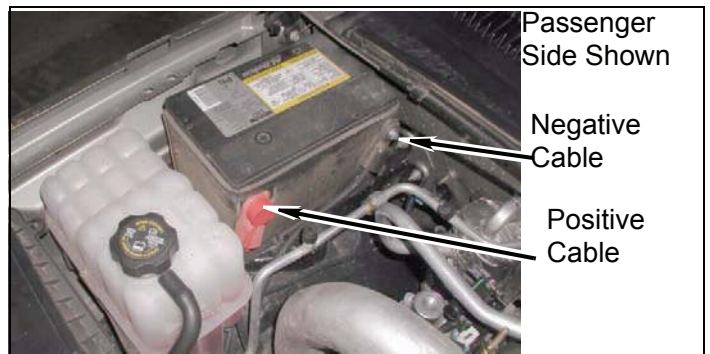

3. Install Gap Guards (you did remember to order your Gap Guards, didn't you?).
4. Stick kit **warning sticker** on the dash in plain sight of all vehicle occupants.

5. Double check the vehicle.

⚠CAUTION

Retorque all fasteners after 500 miles and after off road use. All body lift components should be visually inspected and fasteners re torqued during routine vehicle servicing.

- a. Check all mounting hardware to ensure it is properly tightened.
- b. Check all wires, hoses, cables, etc. to ensure they have been properly connected and there is ample slack. Check all belts and pulleys to ensure there is no rubbing or interference. With the number of hoses on this vehicle, it is vital that this be checked thoroughly.
- c. Check vehicle electrical system.
- d. Start vehicle and check the steering in both directions to ensure that there is no bind. Check clutch operation. Check the operation of the brake system and the parking brake. Check both shift levers' operation. Ensure that there is proper engagement in all gears and 4 wheel drive ranges.

⚠CAUTION

Never open a closed cooling system after the vehicle has been started. Only fill the cooling system if the cap has been removed while the vehicle was still cold.

- e. Check coolant level. Fill coolant to the proper level (refer to the Owner's Manual).
- f. Test drive vehicle in all gears and 4 wheel drive ranges. Pay close attention to all vehicle systems. Check all hardware again in 500 miles and as part of your regular maintenance schedule.

⚠NOTE

All warranty information, instruction sheets, and other documents regarding the installation of this product must be retained by the vehicle owner. Information contained in the instructions and on the warranty card will be required for any warranty claims. The vehicle owner needs to understand the modifications made to his vehicle and how they affect vehicle handling and performance. Failure to provide the customer with this information can result in damage to the vehicle and severe personal injury.

⚠CAUTION

Performance Accessories does not recommend any particular wheel and tire combinations for use with its body lifts and cannot assume responsibility for the customer's choice of wheels and tires. Reference your owner's manual for recommended tire sizes and warnings related to the use of oversized tires. Larger wheel and tire combinations increase stress and wear on steering and suspension components, which leads to increased maintenance and higher risk for component failure. Larger wheel and tire combinations also alter speedometer calibration, braking effectiveness, center of gravity, and handling characteristics. Consult with an experienced local off road shop to find what wheel and tire combinations work best with your vehicle.

PARTS LIST KIT PA10123

QTY DESCRIPTION

2	Bolt , 1/2 x 1 1/2
2	Bolt , 1/4 x 3
25	Bolt , 1/4 x 3/4
8	Bolt , 12-1.75 x 100mm
8	Bolt , 12-1.75 x 180mm
2	Bolt , 14-2.00 x 110mm
4	Bolt , 3/8 x 1 1/2
1	Bolt , 3/8 x 1 3/4
14	Bolt , 7/16 x 1 1/2
2	Bracket , s-shaped, 2"
1	Bracket , s-shaped, 1"
1	Bracket , front bumper driver side
1	Bracket , L-shaped
1	Bracket , L-shaped
2	Bracket , front bumper outer
1	Bracket , front bumper passenger side
1	Bracket , rear bumper driver side
1	Bracket , rear bumper passenger side
2	Bracket , rear bumper studded
1	Bracket , hitch spacer
1	Bracket , lower fan shroud center
1	Bracket , lower fan shroud driver side
1	Bracket , lower fan shroud passenger side
1	Bracket , upper fan shroud center
1	Bracket , upper fan shroud driver side
1	Bracket , upper fan shroud passenger side
2	Bracket , safety cable extension
1	Bracket , support
11	Clip , push
4	Crush block with hole
1	Cover , lower fan shroud, passenger side
2	Hose clamp, #28
2	Hose clamp, #36
1	Hose , heater 5/8 x 14"
1	Label, logo
1	Label, warning

1	Loctite, 6ml
2	Loom clamp (012 SAE)
8	Nut , 1/2-13 Nylock
26	Nut , 1/4 Nylock
2	Nut , 14mm Nylock
5	Nut , 3/8 Nylock
12	Nut , 7/16 Nylock
1	Pin , 4x4 extension, 1/2" X 1"
4	Screw , 5/16 x 3/4, self-tapping
2	Lift block, 3" height x 2" diameter
2	Lift block, 3" height x 2" dia, with 5/8" hole
14	Lift block, 3" height x 3" diameter
2	Spacer , tube 1/2" x 2"
1	Steering extension
1	Extension , fuel filler 2" x 4"
12	Washer , 1/2" USS
2	Washer , thick 1/2" x 3/16" x 1 3/4"
44	Washer , 1/4" SAE
4	Washer , 14mm
2	Washer , 3/16" x 1 1/2" x 2 1/2"
6	Washer , 3/8" SAE
7	Washer , 3/8" USS
4	Washer , 5/16" USS
42	Washer , 7/16" USS
8	Zip tie



PARTS LIST KIT PA10122

QTY DESCRIPTION

2 **Bolt**, 1/2 x 1 1/2
 2 **Bolt**, 1/4 x 3
 25 **Bolt**, 1/4 x 3/4
 8 **Bolt**, 12-1.75 x 80mm
 8 **Bolt**, 12-1.75 x 160mm
 2 **Bolt**, 14-2.00 x 90mm
 4 **Bolt**, 3/8 x 1 1/2"
 1 **Bolt**, 3/8 x 1 3/4"
 10 **Bolt**, 7/16 x 1 1/2"
 2 **Bracket**, s-shaped 2"
 1 **Bracket**, s-shaped, 1"
 1 **Bracket**, bumper, front, driver side
 2 **Bracket**, C-shaped
 1 **Bracket**, bumper, front, passenger side
 1 **Bracket**, bumper, rear, driver side
 1 **Bracket**, bumper, rear, passenger side
 2 **Bracket**, bumper, rear, studded
 1 **Bracket**, fan shroud, lower, center
 1 **Bracket**, fan shroud, lower, driver side
 1 **Bracket**, fan shroud, lower, passenger side
 1 **Bracket**, fan shroud, upper, center
 1 **Bracket**, fan shroud, upper, driver side
 1 **Bracket**, fan shroud, upper, passenger side
 2 **Bracket**, safty cable extension
 1 **Bracket**, support
 11 **Clip**, push
 4 **Crush** block with hole
 1 **Cover** lower fan shroud passenger side
 2 **Hose** clamp, #28
 2 **Hose** clamp, #36
 1 **Hose**, heater 5/8 x 14
 1 Label, logo
 1 Label, warning
 1 Loctite, 6ml
 2 **Loom** clamp (012SAE)
 6 **Nut**, 1/2-13 Nylock

26 **Nut**, 1/4 Nylock
 2 **Nut**, 14mm Nylock
 5 **Nut**, 3/8 Nylock
 10 **Nut**, 7/16 Nylock
 1 **Pin**, shift extension, 1/2" X 1"
 4 **Screw**, 5/16 x 3/4, self-tapping
 2 **Lift** block, 2 height x 2 dia.
 2 **Lift** block 2 height x 2 dia. with 5/8 hole
 14 **Lift** block, 2 height x 3 dia
 2 **Spacer**, tube 1/2 x 2"
 1 **Steering** extension
 1 **Extension** fuel filler 2 x 4
 12 **Washer**, 1/2 USS
 2 **Washer**, thick 1/2 x 3/16 x 1 3/4
 44 **Washer**, 1/4 SAE
 4 **Washer**, 14mm
 2 **Washer**, 3/16 x 1 1/2 x 2 1/2
 6 **Washer**, 3/8 SAE
 8 **Washer**, 3/8 USS
 4 **Washer**, 5/16 USS
 34 **Washer**, 7/16 USS
 8 **Zip** tie