



# Nissan Boss™ Pocket Style® Fender Flares Set of 4

Set Part #71906-02

Rev-8 03/14/2016

For complete fitment info visit : [www.bushwacker.com](http://www.bushwacker.com)

## STEP 1 – PRIOR TO INSTALLATION

- A) Bushwacker only** approves installing the flares according to these written instructions with the hardware provided. **WARNING:** Failure to install according to these instructions will invalidate the warranty. This includes, but is not limited to using alternative installation methods, hardware, or materials. **DO NOT USE:** Loctite, SuperGlue, or similar products on the hardware or the flares.
- B) Fit:** Verify the fit of the flares to vehicle. (Some filing, sanding, or cutting may be necessary to ensure proper fit).
- C) Painting:** (Optional) if paint is desired it must be done prior to installing flares on vehicle. Clean outer surface with a good grade degreaser. **DO NOT USE LACQUER THINNER OR ENAMEL REDUCER AS A DEGREASER.** Wipe outer surface thoroughly with a tack rag prior to paint. Application of plastic adhesion promoter for ABS plastic as per your paint system manufacturer's recommendations is required. Paint flares using a high quality enamel, or polyurethane automotive paint. If painting edge trim (not recommended), use a flex additive.
- D) Performance:** Using larger Tires may increase the area required to turn the vehicle. Some Tire/Rim combinations may require lowering bump stops and or installing steering stops to prevent tire from contacting flare.
- E) Exhaust System:** Modifications may be necessary to maintain a minimum 4" clearance between flares and exhaust pipes. (Exhaust gases should not vent directly onto flares)
- F) Metal Protection:** All exposed fasteners and bare metal should be treated with rust resistant paint **BEFORE** installing flares. Spray inner fender wells with undercoating **AFTER** flare attachments have been completed.
- G) Decals:** Flares may interfere with existing decals on vehicle. If you wish, remove decals prior to installation of flares.
- H) Care & Cleaning:** Bushwacker fender flares are built to last; any detergent you use to wash your vehicle is sufficient to clean the flare. Do not use any harsh abrasive detergents.

## TOOLS FOR EASY INSTALLATION:









- #2 Stubby Philips Screw Driver
- Pry Tool or Flat Bladed Screw Driver
- Grease Pencil
- Electric Drill with 5/16" Bit

**PLEASE READ:** Dirt and debris can become lodged between the fender flares and the vehicle's fenders, causing scratching and paint wear from vibration. Lund International is not responsible for any damage, and the installation of our fender flares is done with the buyer's understanding that this scratching and paint wear may occur.

## LIMITED LIFETIME WARRANTY AGAINST ANY MANUFACTURING DEFECTS

- To claim a warranty, you must provide Proof of Purchase.

## Included in Hardware Kit:

- |   |  |   |  |   |   |   |
|---|--|---|--|---|---|---|
| 1. <br>AD1-0010,<br>LARGE ALCOHOL<br>PREP PAD,<br>2 pcs          | 2. <br>CL1-0005,<br>Dacromet "S"<br>Spring Clip,<br>12 pcs  | 3. <br>GP1-0008,<br>Duro (NC02/S 70)<br>Edge Trim,<br>278 inches | 4. <br>MT1-0002,<br>1" x1" x.017"<br>Black Tab,<br>12 pcs | 5. <br>NU1-0019,<br>5/16-18 Jam Fin.<br>Nylock Nut,<br>29 pcs | 6. <br>SW1-0050,<br>10 x 5/16 Phillips<br>Truss Screw,<br>12 pcs | 7. <br>SW1-0052,<br>T-45 Torx Bit,<br>1 pc |
| 8. <br>SW1-0067,<br>5/16 x 18 x 3/8"<br>SS Torx Screw,<br>29 pcs | 9. <br>WA1-0012,<br>.320 x.700 x.03<br>SS Washer,<br>29 pcs |   |  |   |   |   |

# Flare Installation Procedures:

## STEP 2 - Edge Trim Installation:

- A) Peel two to three inches of red vinyl backing away from edge trim tape. Applying the adhesive side of the edge trim to the inner side of the flare, affix the edge trim to the top edge of the flare (the portion that comes in contact with the vehicle). **See Illustration 1.**
- B) Press edge trim into place along the top edge of the flare in one-foot increments, pulling red vinyl backing free as you continue to work your way around the top edge of the flare.

## STEP 3 - Screw Installation:

*NOTE: DRILL HOLES PRIOR TO PAINT*

- A) Insert stainless steel screw and washer into front of flare, secure with nyloc nut, using a T45 Torx bit and 1/2" Socket. **See Illustration 2.**

## STEP 4 - Front Flare Installation:

- A) Remove factory mud flaps. (Save screws). **See Illustration 4.**
- B) Hold flare in position on fender and, using a grease pencil, mark the three clip locations. Remove flare. **See Illustration 6.**
- C) Using an alcohol wipe, clean the underside of the fender at the forward side of the vehicle. **See Illustration 5.**
- D) Apply three black tabs centered over the marks. These should be flush even with the inner lip of the fender. **See Illustration 3 & 6.**
- E) Attach three of the clips over the tabs. **See Illustrations 3 & 6.**
- F) Peel two inches of red liner from the tape to leave a tab exposed for later use.

- G) Position flare on fender. Apply moderate pressure and install one factory screw in the second highest hole in rear of flare inside the wheel well (circle on the left). Do not tighten. **See Illustration 7.**

*NOTE: THE TAPE ALONG THE FORWARD EDGE OF FLARE SHOULD NOT CONTACT UNDERSIDE LIP OF FENDER AT THIS POINT OR THE CLIPS MAY NOT STAY ON.*

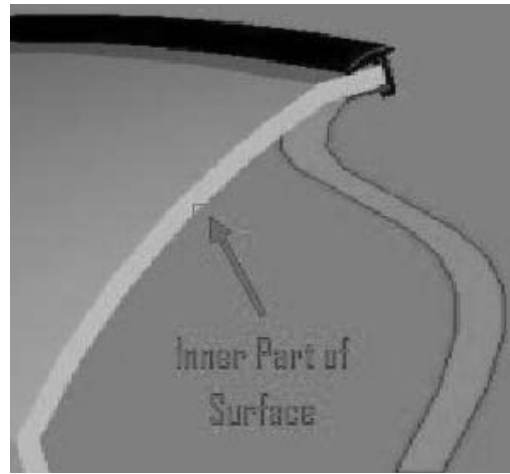

**Illustration #1**

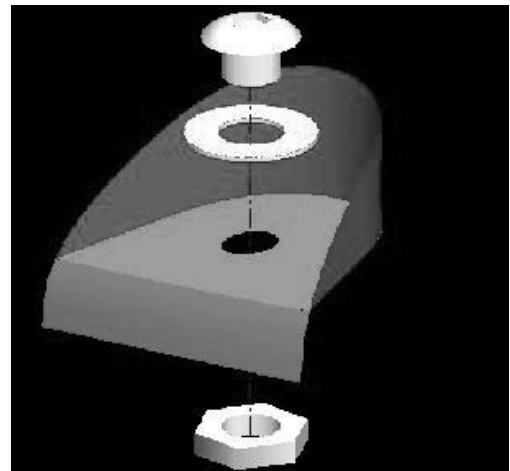

**Illustration #2**



**Illustration #3**

**STEP 4 - Front Flare Installation Continued:**

- H) At the front of the flare, the tape tab is still between the fender and bumper and not in contact with the fender. Install one serrated head screw in the flare hole closest to the front (circle on the right). Do not tighten. **See Illustration #7.**
- I) Install the remaining two serrated head screws in the remaining two upper holes and the two factory screws in lowest rear hole and the hole under the body. Once all screws are in position, tighten. **See Illustration #7.**
- J) Peel the tape liner. Then pulling out and up, adhere the tape to the underside of the fender. Hold for thirty seconds. **See Illustrations #8.**
- K) Repeat for other side.

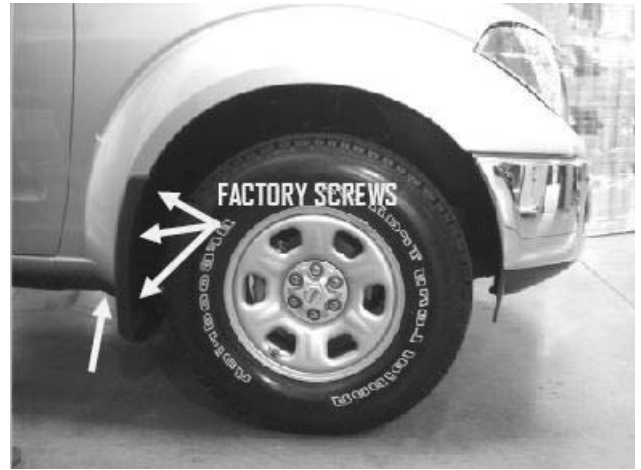

**Illustration #4**



**Illustration #5**



**Illustration #6**



**Illustration #7**



**Illustration #8**

### STEP 5 - Rear Flare Installation:

- A) Remove factory mud flaps. There are four screws and one plastic fastener. Remove strut screw at forward of wheel well. (Save factory screws). **See Illustration 9.**
- B) Hold flare in position on fender and, using grease pencil, mark where the holes in the flare are. **See Illustration 7.**
- C) Place three mounting tabs at the marks on the vehicle. These should be flush with the inner lip of the fender. **See Illustrations 3 & 10.**
- D) Place three clips over the mounting tabs. **See Illustration 3.**
- E) Attach three of the clips over the tabs. **See Illustrations 3 & 6.**



**Illustration #9**

- Hold flare in position on fender using moderate pressure. Line up second lowest screw hole (circled hole) in inner wheel well
- F) of the rear of flare with the factory screw and start. Do not tighten. **See Illustration #11.**

- G) Start clip screws in each clip location and start the two factory screws at rear of flare. Do not tighten. **See Illustration #11.**

Ensuring the flare is properly located on fender, apply moderate pressure to outside surface of flare, and tighten screws, beginning with the first replaced factory screw and

- H) working toward the front of the fender flare then going back to the other two factory screws at rear of flare.

Reinstall the factory screw at the front of the flare with a

- I) 10mm socket, threading it into the strut behind the sheet metal. **See Illustration #11.**

Repeat for other side.



**Illustration #10**



**Illustration #11**