



**07 & UP 4WD GM 1500 3.5" FRT
 1.75" REAR LIFT KIT**

Thank you for choosing Rough Country for your suspension needs.

Rough Country recommends a certified technician install this system. In addition to these instructions, professional knowledge of disassemble/reassembly procedures as well as post installation checks must be known. Attempts to install this system without this knowledge and expertise may jeopardize the integrity and/or operating safety of the vehicle.

Please read instructions before beginning installation. Check the kit hardware against the parts list on the rear cover of these instructions. Be sure you have all needed parts and know where they go. Also please review tools needed list and make sure you have needed tools.

PRODUCT USE INFORMATION

As a general rule, the taller a vehicle is, the easier it will roll. Seat belts and shoulder harnesses should be worn at all times. Avoid situations where a side rollover may occur.

Generally, braking performance and capability are decreased when larger/heavier tires and wheels are used. Take this into consideration while driving. Do not add, alter, or fabricate any factory or after-market parts to increase vehicle height over the intended height of the Rough Country product purchased. Mixing component brands is not recommended.

Rough Country makes no claims regarding lifting devices and excludes any and all implied claims. We will not be responsible for any product that is altered. If question exist we will be happy to answer any questions concerning the design, function, and correct use of our products.

This kit does not fit vehicles equipped with electric power steering.

This kit is packaged as a leveling kit- raising the front 3.5+and the back 1.75+. If you desire a different look or if the vehicle has a tool box or added weight in the rear, please consult with your sales representative about other block and u-bolt options.

This suspension system was developed using a 32 x 11.5 tire with factory wheels. Examples of tire sizes that can be used are 285/75R17, 285/65R18, or 285/55R20. **Note** if wider tires are used, offset wheels will be required and trimming may be required.

NOTICE TO DEALER AND VEHICLE OWNER

Any vehicle equipped with any Rough Country product should have a **Warning to Driver**+decal installed on the inside of the windshield or on the vehicle's dash. The decal should act as a constant reminder for whoever is operating the vehicle of its unique handling characteristics.

Tools Needed:

- 18MM Wrench
- 15MM Wrench
- 21MM Wrench
- 11MM Wrench
- 10MM Wrench
- 17MM Wrench
- Floor Jack
- Jack stands
- Thread Locker

Torque Specs:

Size	Grade 5	Grade 8
5/16+	15 ft/lbs	20 ft/lbs
3/8+	30 ft/lbs	35 ft/lbs
7/16+	45 ft/lbs	60 ft/lbs
1/2+	65 ft/lbs	90 ft/lbs
9/16+	95 ft/lbs	130 ft/lbs
5/8+	135 ft/lbs	175 ft/lbs
3/4+	185 ft/lbs	280 ft/lbs

	Class 8.8	Class 10.9
6MM	5 ft/lbs	9 ft/lbs
8MM	18ft/lbs	23 ft/lbs
10MM	32ft/lbs	45ft/lbs
12MM	50ft/lbs	75ft/lbs
14MM	85ft/lbs	120ft/lbs
16MM	130ft/lbs	165ft/lbs
18MM	170ft/lbs	240ft/lbs

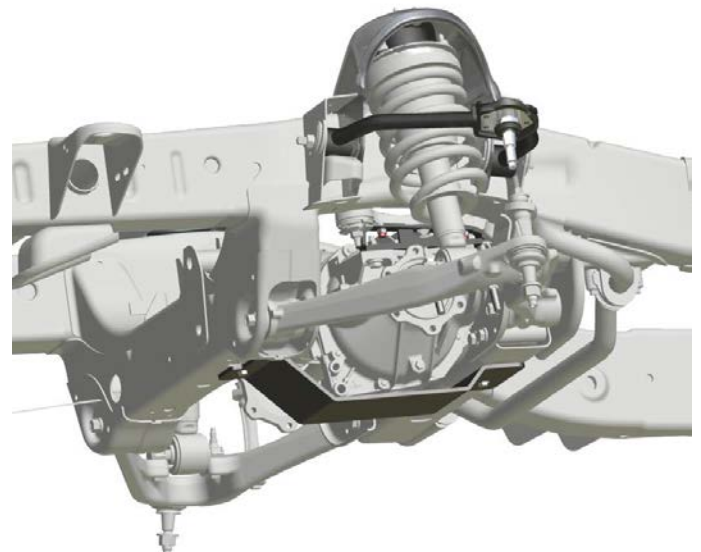

FRONT INSTALLATION

1. Park the vehicle on a level surface and chock the rear wheels.
2. Jack up the front of the vehicle. Place jack stands under the frame rails and lower onto jack stands letting the front suspension hang.
3. Remove the tires and wheels. Remove the upper and lower factory skid plates using a 15mm wrench. Retain factory hardware and front skid plate for reuse.
4. Using a 21mm wrench, remove the tie-rod nut as shown in **Photo 1**. Strike the side of the mount to dislodge the tie rod end. Remove from the knuckle.
5. Remove the sensor wire from the plastic clip. Remove the bracket from the control arm using a 10mm wrench. **See Photo 2.**

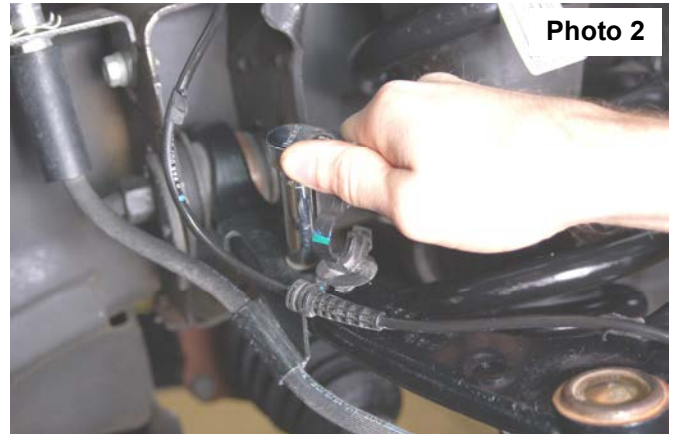
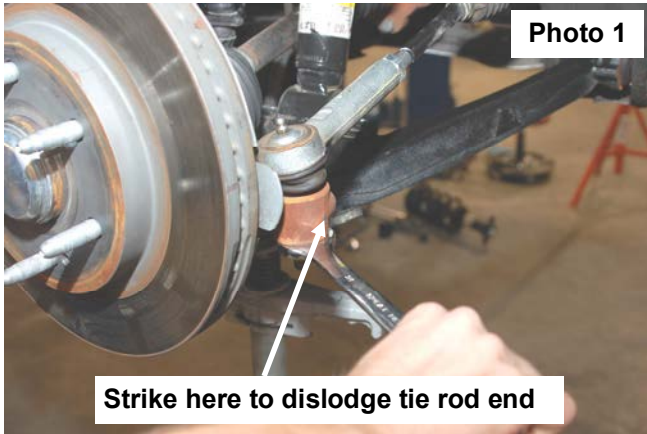

6. Remove and unplug the ABS sensor wire from the frame as shown in **Photo 3**.
7. Remove the upper ball joint nut using a 18mm wrench. **See Photo 4**. Strike the knuckle as shown to dislodge the ball joint. Separate the upper control arm from the knuckle.



8. Using a 18mm wrench, remove the upper strut nuts as shown in **Photo 5**. Retain factory hardware for reuse.
9. Using a 15mm wrench, remove the 2 bolts securing the lower strut mount to the lower control arm and remove the strut from the vehicle. Remove and discard the factory lower retainer clips. New hardware will be used. **See Photo 6.**

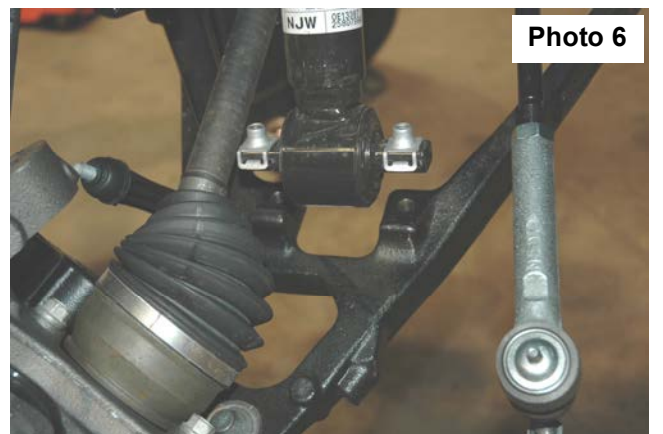

10. Mark location of alignment cams on upper control arms to allow installation of new arm to same position. Using a 21mm wrench and 21mm socket, remove the upper control arms from the vehicle. **See Photo 7.** Retain the hardware
11. Using a 11mm wrench, remove the drive shaft bolts. **See Photo 8.** Retain hardware for reuse.



Photo 7

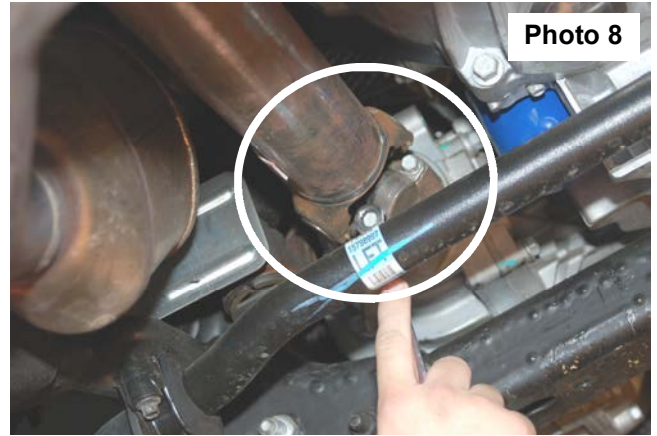

Photo 8

12. Place a floor jack under the differential assembly to provide support for following steps.
13. Using a 15mm wrench, remove the 6 axle shaft bolts and secure axle shafts out of the way. **See Photo 9** Repeat on opposite side. Retain the factory hardware for reuse. Unplug the electrical connector on differential as shown in **Photo 10** and unplug the diff vent hose. **Photo 11**
14. Using a 18mm socket remove the 4 differential bolts (2 each side) securing the differential to the frame. **See Photo 9.**
15. Slowly lower differential assembly to the ground.
16. Using a hand grinder. Grind away marked portion of the cooling fin as shown in **Photo 12** and **Photo 13.** Grind until flush with casing.



Photo 9

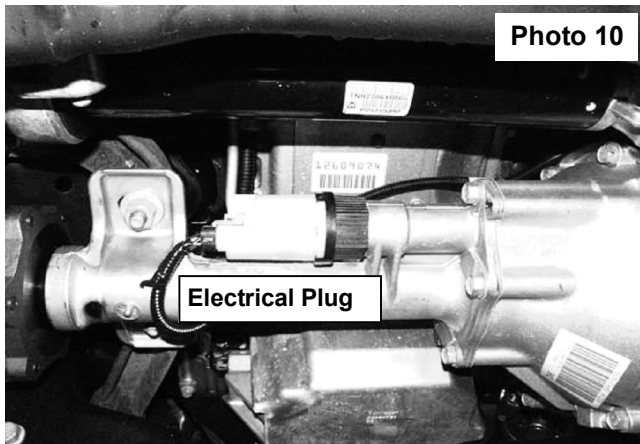

Photo 10

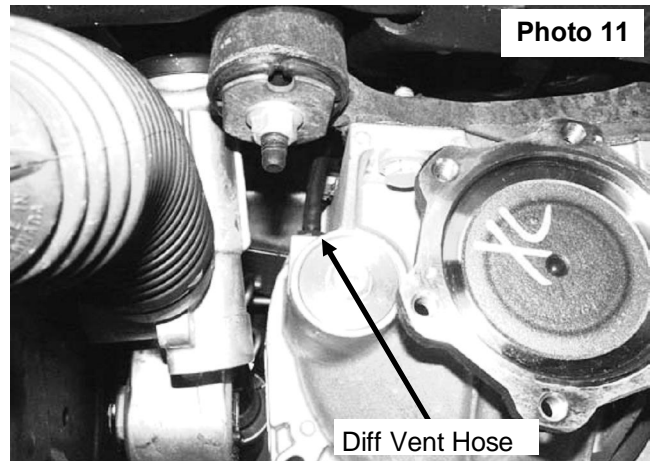

Photo 11

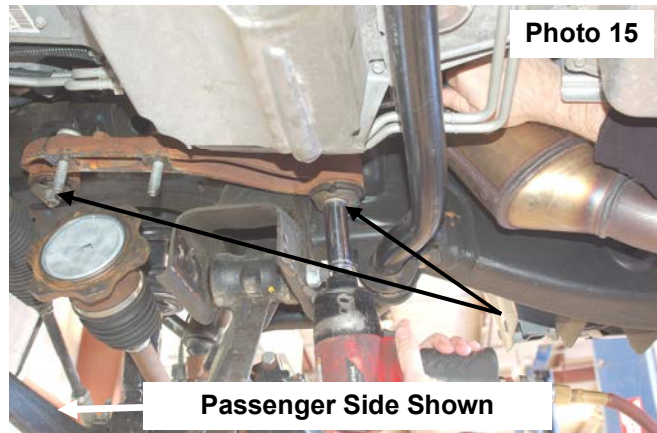
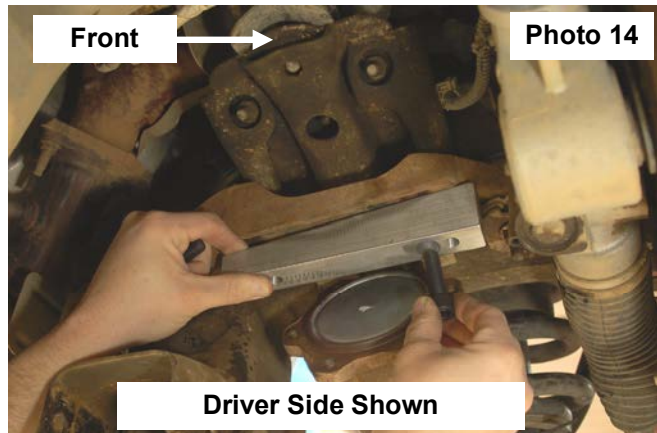

Photo 12

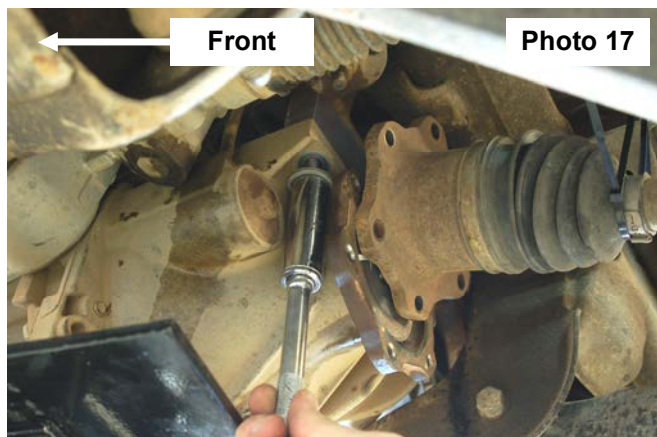

Photo 13

17. On the Drivers side, locate and secure the new diff mount drop bracket to the stock location using the supplied 12mm x 45mm socket head bolts. Tighten using a 10mm Allen head. **Note that the narrower diff drop bracket will install on the driver side of the vehicle with the taller part to the front. See Photo 14.**
18. Remove the stock differential bracket on the passenger side using a 18mm & 15mm socket / wrench. **See Photo 15.**



19. Remove the factory studs using a hammer and then reinstall the factory mount. Tighten using a 18mm & 15mm wrench
20. Install the supplied diff bracket to the stock mount as shown in **Photo 16** with the supplied 12mm x 70mm socket head bolts & 12mm lock nuts. Make sure the taller end of the bracket is to the front. Tighten using a 18mm socket/ wrench.
21. Using the supplied 12mm x 80mm long set screw, insert them into the new diff mount as seen in Photo 16. Tighten with a 10mm allen wrench.



22. Reinstall the differential to the Rough Country diff drop brackets with the factory bolts on the drive side and factory nuts on the passenger side. Tighten using a 18mm socket.
23. Reconnect the connector plug on the differential & pull the vent hose down slightly and reinstall on the differential. The differential vent hose may be tapped to the electrical loom. If so separate and slightly pull for slack.
24. Reinstall the axle shafts to the differential with the factory hardware using a 15mm socket as removed in Step 15.
25. Install the new control arm as shown in **Photo 18** in the factory mount making sure the 1/4+stud for mounting the brake line bracket is toward the rear with the factory hardware. Tighten using mark made as a reference in Step 10 and using a 21mm wrench & socket. **Passenger side shown.**
26. Locate the supplied strut spacer and install the supplied 10mm stud extensions. Using a 17mm socket snug the stud in the new spacer as shown in **Photo 19.**



27. Install the strut spacer on the factory strut with factory hardware and using a 18mm wrench. **See Photo 20.**
28. Install the strut assembly in the factory mount with the supplied 10mm nuts/washers & lock-washers on the upper mount. Tighten using a 17mm wrench. **Note: Flat washer must be installed on studs. See Photo 21.**

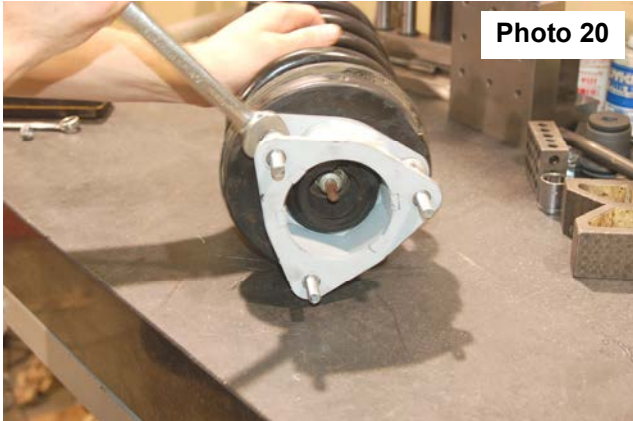

Photo 20

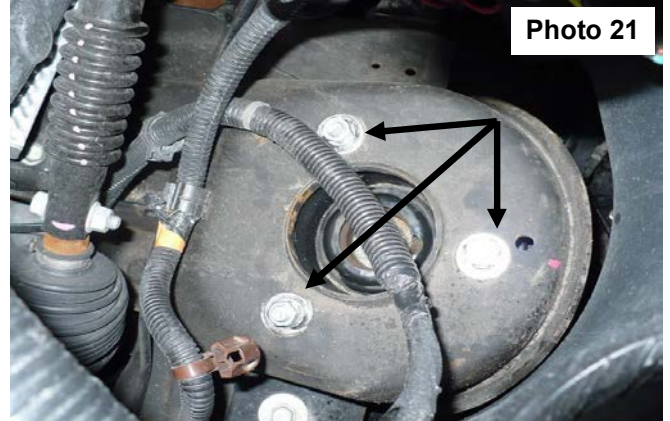

Photo 21

29. Install the strut in the lower control arm using the supplied 3/8+2 1/4+bolts /washers & nuts using a 9/16+wrench. **See Photo 22.** It may be necessary to jack up the lower control arm with a floor jack to align lower strut holes.
32. Reinstall the sway bar on the lower control arm using a 15mm wrench.
33. Reinstall the knuckle to the upper control arm with the supplied castle nuts/cotter pins. Tighten using 3/4+wrench to **50 ft/lbs. DO NOT OVER-TORQUE THE CASTLE NUT.** Reinstall the tie rod end into the knuckle with factory hardware and using a 21mm wrench.
34. Reinstall the driveshaft with the factory hardware using a 11mm wrench.
35. Install the brake line bracket on the new control arm with the supplied 1/4+lock nut / washer and using a 7/16+wrench. **See Photo 23. Driver side shown.**



Photo 22



Photo 23

36. Reconnect the ABS wire that was disconnected in Step 6.
37. Locate and install the new lower skid plate below the differential in the factory location (if equipped) with the factory hardware and using a 15mm wrench. **See Photo 24.** If not equipped with a factory skid plate, use the supplied 3/8+self tapping bolts to install the skid plate in the holes in cross-member.
38. Reinstall the wheels/tires.
39. Jack up the vehicle and remove the jack stands.
40. Lower the vehicle to the ground.



Photo 24

REAR INSTALLATION

1. Chock the front wheels.
2. Place a floor jack under the differential and jack up the rear of the vehicle.
3. Place jack stands under the frame rails and lower onto the jack stands.
4. Remove the tires/wheels.
5. Remove the factory shock absorbers using a 21mm wrench & socket. Retain the factory hardware for reuse.
6. Remove the factory u-bolts using a 21mm socket, then remove the factory blocks. Lower the axle using the floor jack to allow for the new 3+block to be installed.

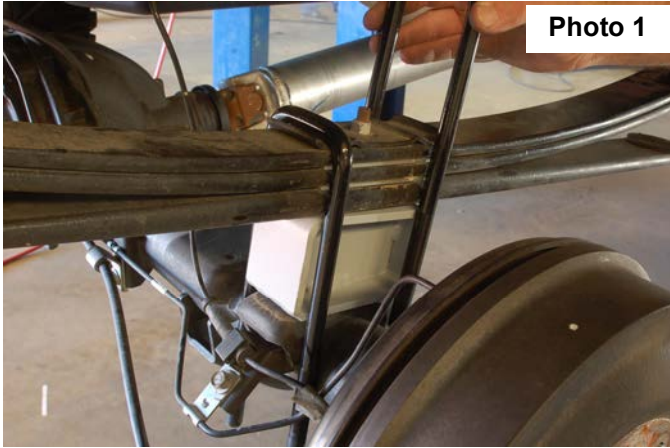

7. Install the block on the factory spring pad with the flat part of the block on the spring and the thinner end towards the front. Jack up the axle to meet the springs, making sure to align the center pin. **See Photo 1**
8. With the floor jack applying slight pressure to the rear axle to keep the pin aligned, install the new supplied u-bolts and tighten in a crossing pattern, using a 7/8+socket.
9. Locate the new shock absorbers part # 658726, and install the shock absorbers in the factory mounting locations using the factory hardware. Tighten using a 21mm wrench & socket. **See Photo 2**
10. Install the tires/wheels.
11. Jack up the vehicle to remove the jack stands. Remove the jack stands and lower the vehicle to the ground.

POST INSTALLATION INSTRUCTIONS

1. Lightly grease the ball joints. Do not over grease the ball joint as this could cause ball joint boot failure.
2. Have a qualified alignment center align the vehicle immediately.
3. Have headlights adjusted to proper settings.
4. Wheels must be retighten at 50 miles.
5. All kit components must be retightened at 500 miles and then every three thousand miles after installation. Periodically check hardware for tightness.
6. Install **Warning to Driver** decal on sun visor.
7. On some vehicles the front lower skirting will need to be trimmed if using certain wheel /tire combinations and with heavy offset wheels. Trim only as needed.

Box Kit

1-Driver Side Control Arm
1-Pass Side Control Arm
1-Driver Side Diff Bracket
1-Pass Side Diff Bracket
1-Diff Lower Skid Plate
2-Strut Spacers
4-9/16" x 10 1/2" U-bolts
2-3" spacer blocks
2-Rear Shock Absorbers

Kit Poly Bag

1-12mm x 45mm Socket head Bolt
1-12mm x 70mm Socket head Bolt
2-12mm x 80mm Set Screws
4-3/8" x 2 1/4 bolts
8-3/8" washers
4-3/8" lock nuts
2-1/4" nut
2-3/8 self tapping bolts

10mmstudbag

6-10mm Studs
6-10mm Lock Washers
6-10mm Flat Washers
6-10mm Nuts

KIT CONTENT



Thank you for choosing Rough Country for your suspension needs.

