

NOTE: If the fuse panel on your 510217 59-60 Impala kit ***DOES NOT*** have a sticker like the photo at the left, you have the first design harness and your instructions are listed below and follow this page.

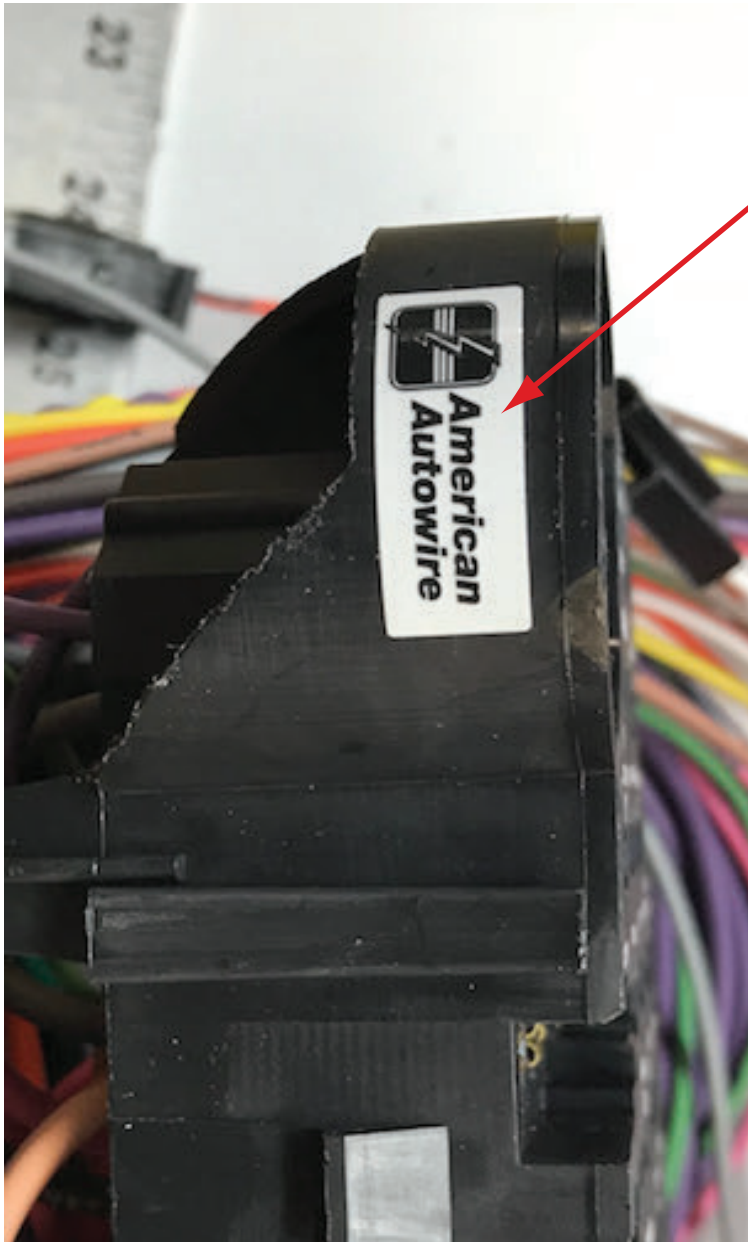

Number	Description
500332	Headlight Switch
500707	Fuse, Relay, and Flasher kit
500471	Courtesy Light kit
500684	Ignition Switch
500919	Practice Terminal Crimping Set
510219	Dash Harness kit
510220	Engine Wiring Kit
510221	Front Light Wiring kit
510223	Instrument Cluster Wiring kit
510222	Rear Body Wiring kit
510476	Alternator and main power Connection kit
500237	Floor Dimmer Switch
92969720	Firewall Mod. Template Sheet
92969698	Kit Introduction Instruction Sheet
92970016	Warning Sheet



www.americanautowire.com 856-933-0801

59-60 Impala First Design Instructions

92972904 rev. 0.0 2/28/2020

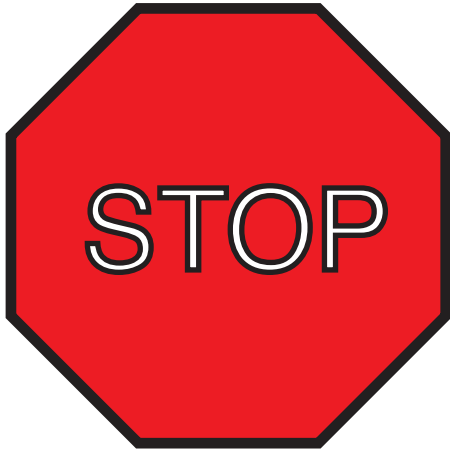

WARNING:

Validate the kit contents with the component list included on page 2 of this sheet before proceeding. This kit is intended to be used in a modified vehicle. Please read this sheet thoroughly and be sure that you understand everything explained on it prior to opening any of the enclosed packages, or before attempting to install any of the components. Once this kit has been opened or a component installed, the kit is not returnable.

1. This kit should typically be used in a **MODIFIED** application only.
2. This kit supports the use of factory heater systems and aftermarket heater and A/C systems. The kit supplies power to a factory A/C control head but **DOES NOT** include the actual A/C harness for an original factory A/C vehicle. Factory original A/C harnesses are available under our Factory Fit product line as they are self contained harnesses made to fit and work with the stock A/C component configuration.
3. This kit supports the use of a high current self-exciting 1-wire alternator or other style internally regulated alternators. An adapter may be necessary in some applications. The use of a stock, low amperage alternator is seriously discouraged as they cannot handle the higher current requirements of updated ignition systems, electric fans, aftermarket A/C systems, stereo systems, air ride suspensions, and other power hungry accessories and will ultimately create performance issues with the system.
4. This kit **WILL NOT** support the use of a factory ammeter. All AAW kits are engineered to supply the optimum charge to the battery. To achieve this performance, we route our 6ga. charge wire directly from the alternator output charge terminal to the starter battery terminal. Due to the path of the charge being altered from the stock configuration, the gauge can no longer see a charge vs. a discharge, so it will not work properly. When ammeters were originally used, most generator or alternator current outputs were rated at a maximum of about 25-60 amps. Modified cars being built today typically utilize a 100 amp or higher output alternator. With these higher current units, ammeters, generally speaking, become a safety hazard. Ammeters are usually wired in parallel to the charging circuit, are typically unfused, and can short very easily causing a fire. A voltmeter is recommended as a good alternative.
5. This kit **IS NOT** set up with a resistance wire for a standard, points type ignition system. It is wired with a full 12 volt primary ignition feed that is hot in the run position. Primary ignition voltage in the starting position is handled via a full 12 volt bypass wire. Our system will support HEI, MSD, other electronic ignition systems, as well as most all computerized Fuel Injection systems. If you wish to run a points type system, there are illustrations on the engine connection pages to do so. Extra parts (ballist resistor) that are not included in this kit will be required to complete that operation.



510217

510217 - Classic Update Series Kit 1959-60 Chevrolet Impala

This kit contains the following components:

<u>Bag</u>	<u>Part Number</u>	<u>Description</u>	<u>Quantity</u>
	500332	Headlight Switch	1
N	500471	Courtesy Light kit	1
	500684	Ignition Switch	1
	500707	Fuse, Relay, and Flasher kit	1
	500919	Practice Terminal Crimping Set	1
G	510219	Dash Harness kit	1
J	510220	Engine Wiring Kit	1
L	510221	Front Light Wiring kit	1
M	510222	Rear Body Wiring kit	1
H	510223	Instrument Cluster wiring kit	1
	510237	Floor Dimmer Switch	1
Z	510476	Alternator and Main Power Connection kit	1
	92969698	Kit Supplemental Instruction Sheet	1
	92969720	Firewall Modification Template	1
	92970016	Warning Sheet	1

Validate the kit contents with this component list. If there are any discrepancies with incorrect or missing parts, stop your installation and notify the supplier you purchased the kit from before proceeding.



www.americanautowire.com 856-933-0801

510217

92970016 instruction sheet Rev 2.0 1/12/2018

Classic Update Series

1959-1960 Impala

START HERE !

PLEASE READ THIS BEFORE STARTING INSTALLATION !

This wiring kit is designed for ease of installation. Please read the guidelines below, BEFORE STARTING your installation to guarantee a successful job. Use an appropriate crimping tool which folds the wings of the open barrel terminals down into the wire as shown below. ALL TERMINALS THAT YOU INSTALL SHOULD BE PROPERLY SOLDERED. Our factory terminations are installed by GM approved five ton presses, and soldering is not necessary on these terminations.



AS THIS HARNESS IS DESIGNED FOR USE IN A MODIFIED CAR REQUIRING A HIGHER RATE OF CHARGE, IT DOES NOT SUPPORT THE USE OF A STOCK (ORIGINAL) GENERATOR. IT IS DESIGNED FOR USE WITH AN INTERNALLY REGULATED "SI" OR SINGLE WIRE STYLE ALTERNATOR. IT CAN ALSO BE USED WITH THE LATER "CS" AND "CS-D" UNITS BY USING THE ADAPTERS WHICH ARE SOLD SEPARATELY. CONTACT AAW OR YOUR FAVORITE DEALER FOR THE PROPER ADAPTER FOR YOUR CAR.

STEP 1: DISCONNECT YOUR BATTERY:

Disconnect the battery before installing the wiring kit to prevent any accidental shorting caused by loose bare wire ends.

STEP 2: START INSTALLING KIT:

This kit is broken down into individual steps that are identified by a letter printed on the instruction sheets visible through each bag. These letters are the order of operation for installing your kit. Start with bag letter G, then H, etc. The order of installation is shown below.

G 510219 Dash Harness Kit
H 510223 Instrument Cluster Kit
J 510220 Engine Kit
L 510221 Front Light Kit
M 510222 Rear Body Kit
N 500471 Courtesy Light Kit
Z 510476 Alternator and Main Connection Kit

STEP 3: RECONNECT YOUR BATTERY:

When you have completed the installation and are ready to reconnect the battery, make sure that the following electrical system grounds are in place:

A. Battery is grounded to the ENGINE BLOCK.
B. Battery is grounded to the frame.
C. Engine block is grounded to the frame.
D. Body is grounded to the frame.

STEP 4: CHECK ALL ELECTRICAL FUNCTIONS:

Any non-functioning items should be checked for proper installation. Any problems with your wiring and electrical circuit functions should be addressed to American Autowire Systems, Inc. as soon as possible to avoid any warranty problems.

If you have any questions concerning this or any of our products, please feel free to call us at 1-856-933-0801.

AMERICAN AUTOWIRE MAKES IT EASY !!

We carry many accessories for your 59-60 Impala

p/n R0067108
OEM style non-stick harness tape

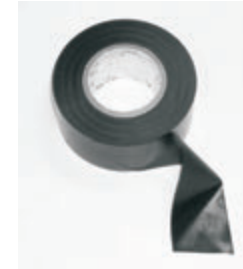

OEM style wiper switch.
p/n 01993543 (59-60) 2 spd w/washer
p/n 01993541 (59-60) 1 spd w/washer

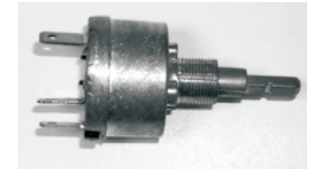

p/n 01998728 (59-60)
T-10 4 speed back up lamp switch.



p/n 500649
OEM small terminal crimping tool (18-14 gauge).



p/n 500523
OEM large terminal crimping tool (12-8 gauge).



p/n 38131
Breakerless Ignition Module,
GM V-8 POINT CONVERSION KIT



p/n 36318 (1959)
p/n 36319 (1960)

Factory assembly manual.
(It's what they used on the assembly line to build your Impala!)

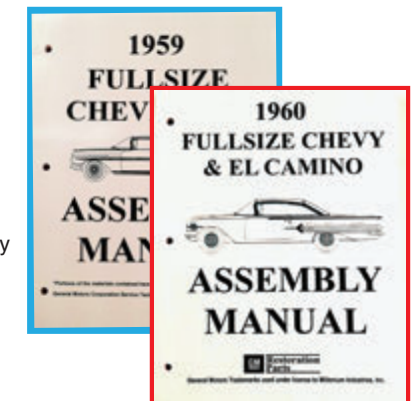

www.americanautowire.com 856-933-0801

Classic Update Series

1959-1960 Impala

510217

© COPYRIGHT 2004 American Autowire / Factory-Fit
Used with express permission of
American Autowire / Factory-Fit
92969698 instruction sheet rev. 2.0 1/12/2018

Classic Update Series

1959-1960 Impala



www.americanautowire.com 856-933-0801

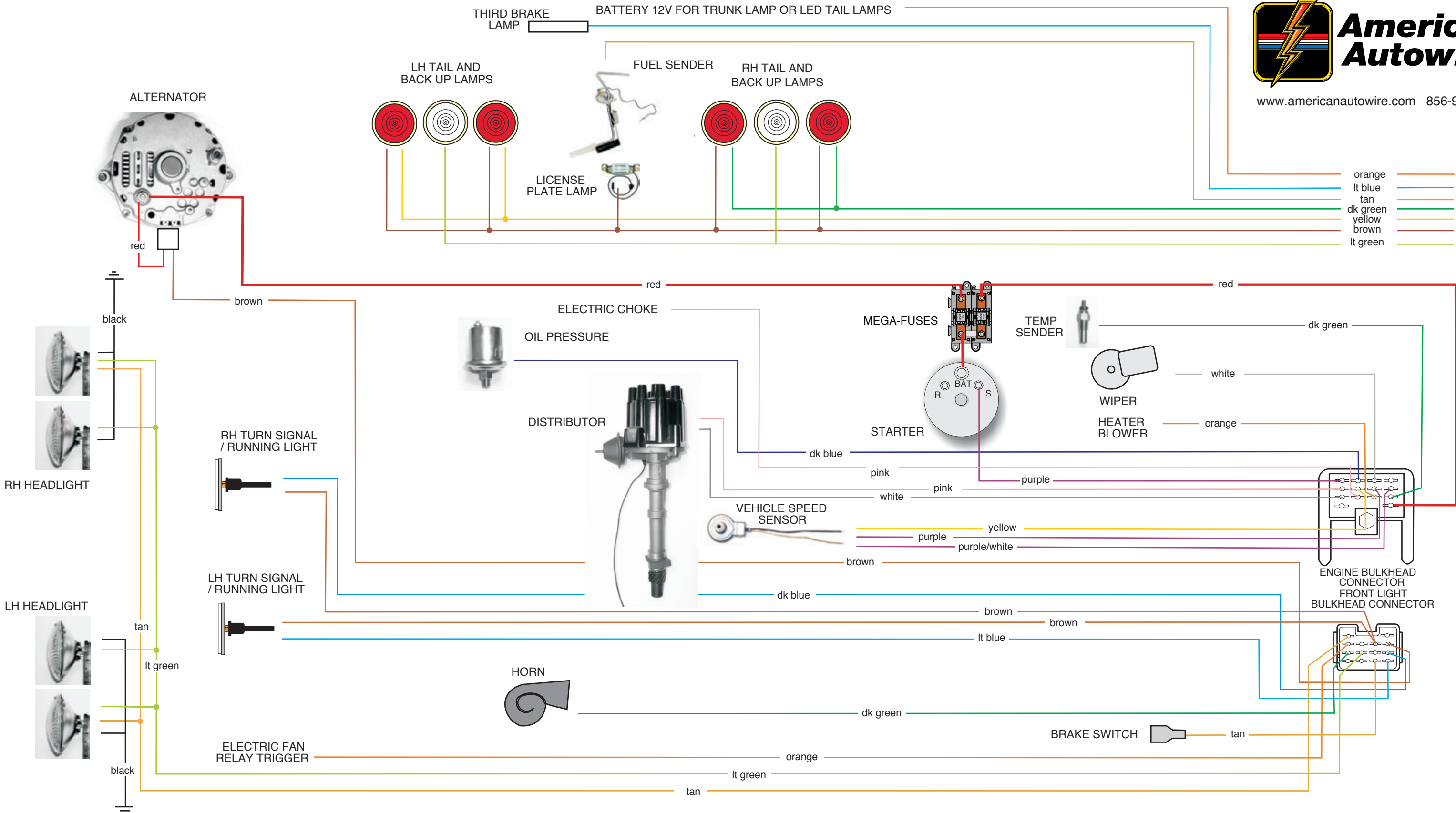

NOTICE: This schematic drawing is for reference only. Do not use the schematic to install this wiring kit! Use the instruction sheets included in each bag, which includes directions for proper terminations, connector indexing, and specific applications.

510217

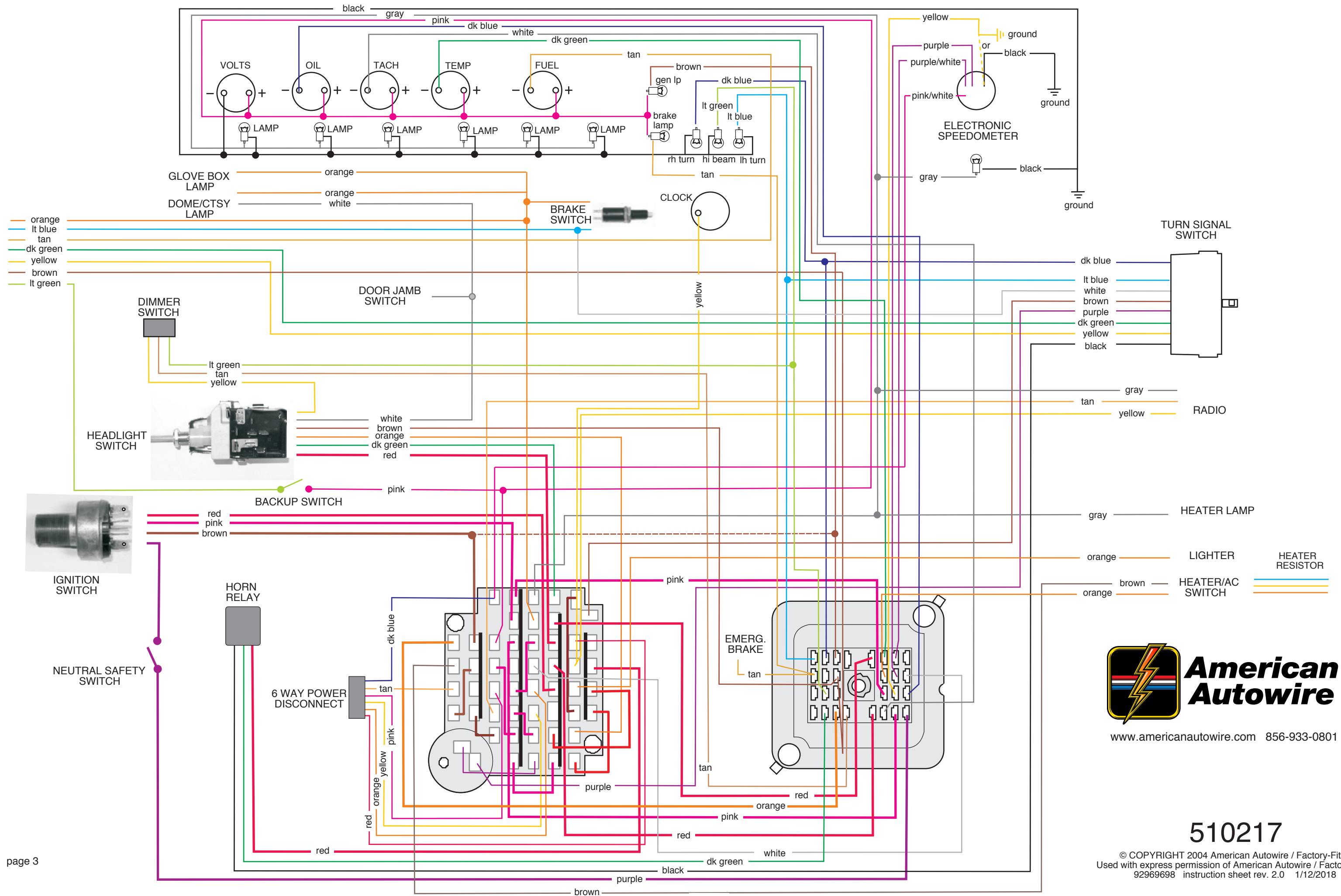

www.americanautowire.com 856-933-0801

510217

© COPYRIGHT 2004 American Autowire / Factory-Fit
 Used with express permission of American Autowire / Factory-Fit
 92969698 instruction sheet rev. 2.0 1/12/2018

THIS PAGE HAS INTENTIONALLY BEEN LEFT BLANK



www.americanautowire.com 856-933-0801

510217

© COPYRIGHT 2004 American Autowire / Factory-Fit
Used with express permission of American Autowire / Factory-Fit
92969698 instruction sheet rev. 2.0 1/12/2018

Template for firewall modification for 1959-1960 Chevrolet Classic Update Kit

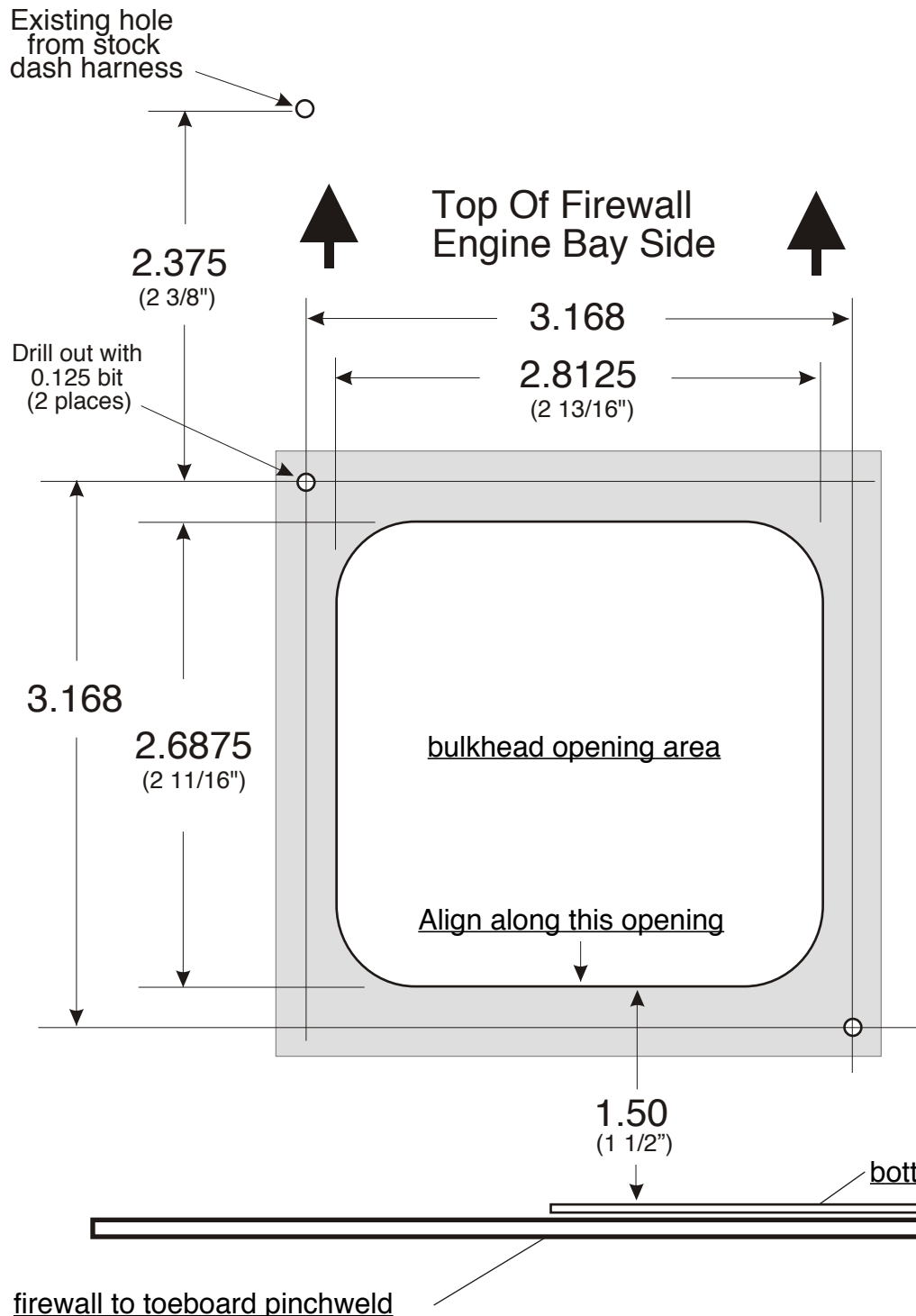

Most Classic Update Series kits are based on the 1968 and later GM bulkhead assembly which has a different mounting footprint than earlier bulkhead connectors. This template will be used for this purpose. We suggest that this template be attached to stiff cardboard, a thin piece of plastic, or applied directly to the firewall. The white area can then be cut out with a razor knife to define the area of material that needs to be removed from the existing bulkhead area. If you will be applying the template directly to the firewall, remove the white area prior to affixing it to the firewall and be sure to carefully clean any grease, oil, or wax from the mounting area prior to affixing the template to the firewall.

Proceed as follows:

1. Position the template against the firewall by aligning the bottom of the bulkhead opening area on the template and measuring up about 1 1/2 inches from the bottom firewall flange as shown to the left.
2. Locate the existing upper mounting hole from the original stock dash harness and position the new upper hole that is to be drilled per the template directly down 2 3/8 inches from the original hole as shown to the left.
3. Trace the bulkhead opening area from the template onto the existing firewall or spray some paint over the opening area and allow it to dry.
3. Drill the two new 0.125 holes for the new bulkhead mounting screws as per the template. Remove the template from the firewall to view the traced or painted area and cut that area out.
4. Install the fuse box assembly from the passenger compartment side and check the fit into the new bulkhead opening. It may be necessary to do some fine tuning on the opening for an exact fit.
5. Attach the new fuse box and dash harness to the firewall using the provided screws to complete this part of the installation.

PRINT ON ADHESIVE LABEL SHEET

92969720

92969720 Rev 2.1 2/14/2017

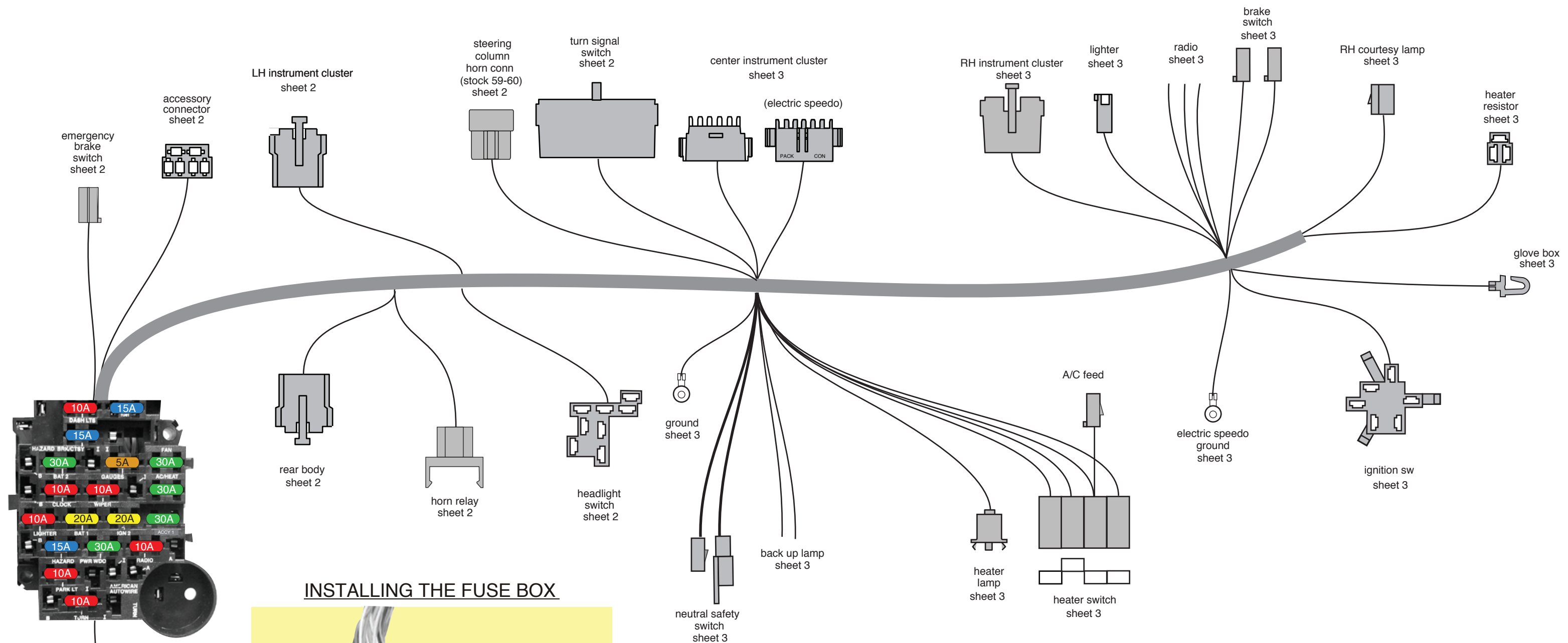

INSTALLING THE FUSE BOX

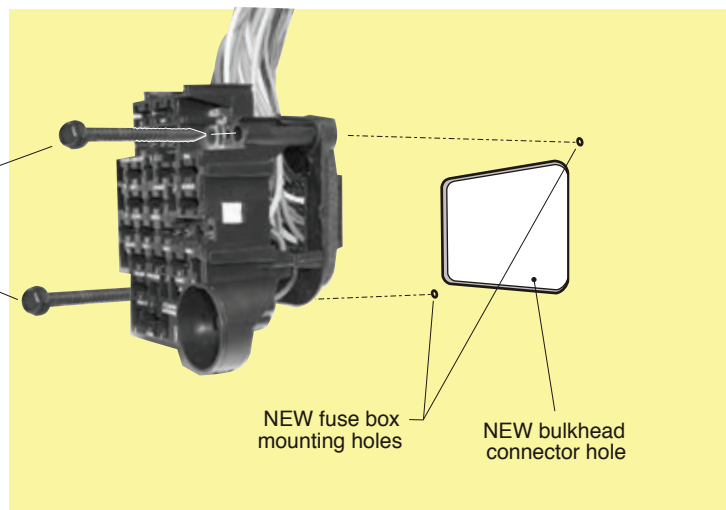

1. Locate the stock OEM bulkhead hole in the driver side of the firewall. **NOTE: You will need to modify the firewall of your car by making a completely new, larger hole. See firewall template 92969720 to help with this operation.**
2. Mount the fuse box with the flasher can in the bottom right corner, as shown above.
3. Using the two mounting screws A, attach the fuse panel to the firewall.

Fuse Panel Installation Instructions

Following these simple instructions will guarantee a successful installation of your American Autowire fuse panel harness.

1. Study the diagram above to familiarize yourself with the dash harness.
2. Modify your firewall opening and install the fuse box (see item #1 below left, and 92969720 template).
3. Route the dash harness using the factory support straps.
4. Make all connections as shown on the following pages of this dash harness kit.
5. Once this harness is installed, continue to bag 'H', and install the rest of the kit (bags H,J,K,L,M).
6. See sheet 2 regarding plugs for the original engine and forward lamp harness bulkhead holes.



**American
Autowire**

www.americanautowire.com 856-933-0801

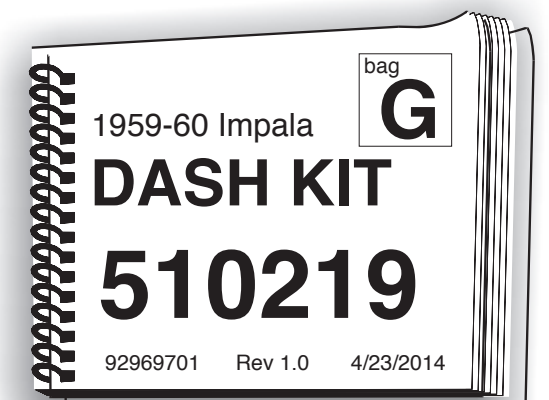

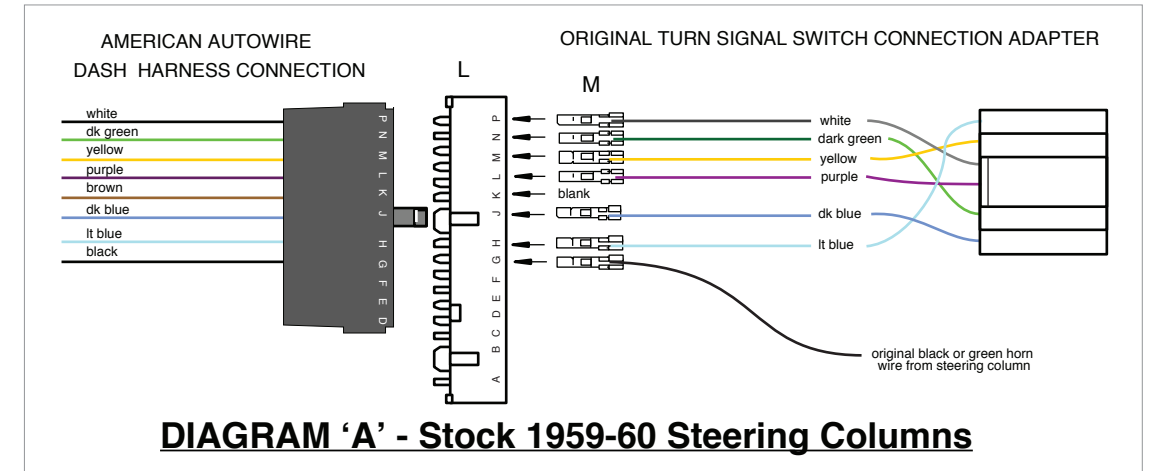
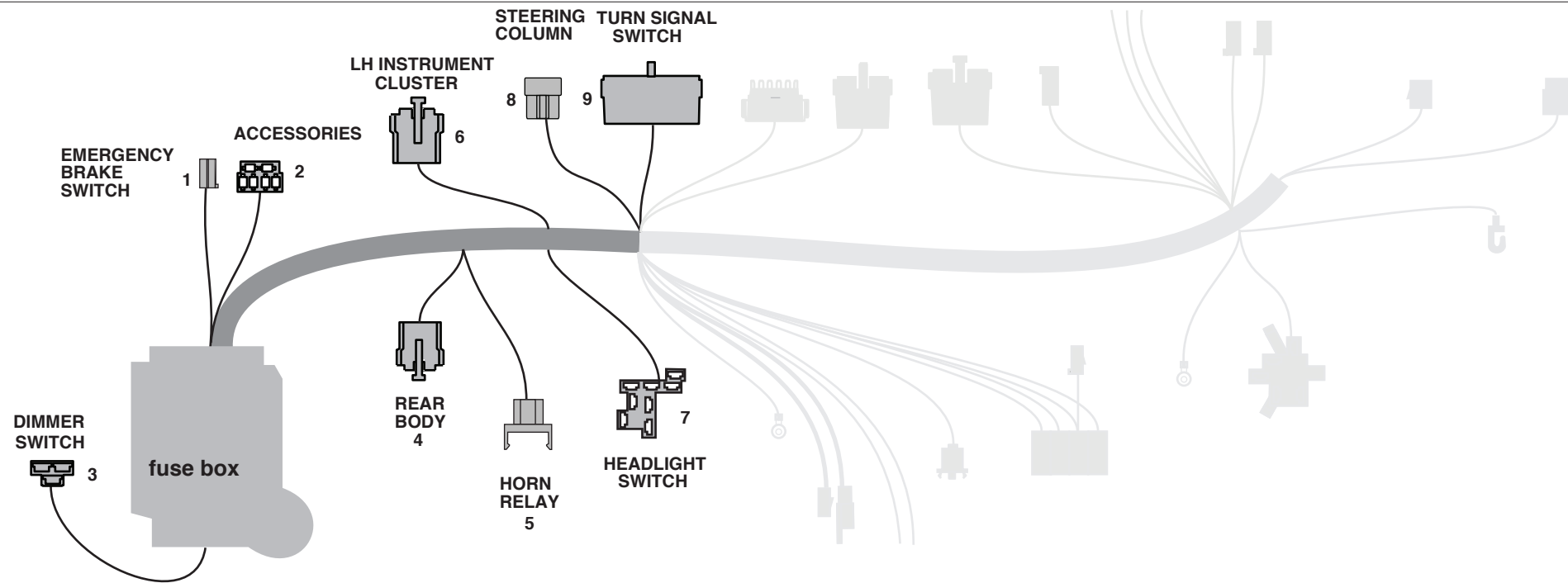

1	EMERGENCY BRAKE	Tan Pink	Connect to the emergency brake switch. This is the ground circuit for the brake warning switch lamp. Switched 12 volt to warning lamp Ignition 12 volt feed to parking brake warning switch																					
2	ACCESSORIES	Dark Blue Orange Red Pink Yellow Tan	Use the provided connector that is plugged into the dash harness along with the loose terminals in the loose piece parts kit to connect power leads for the following: <table border="1"> <thead> <tr> <th>Fuse</th> <th>Rating</th> <th></th> </tr> </thead> <tbody> <tr> <td>FUEL</td> <td>15 amp</td> <td>Fused 12 volt IGNITION feed for fuel pump (may also be used to feed power to another ignition circuit)</td> </tr> <tr> <td>BAT1</td> <td>20 amp</td> <td>Fused 12 volt BATTERY feed for power seats (may also be used to feed power to another battery circuit)</td> </tr> <tr> <td>BAT2</td> <td>30 amp</td> <td>Fused 12 volt BATTERY feed for power door locks (may also be used to feed power to another accessory circuit)</td> </tr> <tr> <td>IGN1</td> <td>20 amp</td> <td>Fused 12 volt IGNITION feed for cruise control (may also be used to feed power to another ignition circuit)</td> </tr> <tr> <td>PWRWDO</td> <td>30 amp</td> <td>Fused 12 volt IGNITION feed for power windows (may also be used to feed power to another ignition circuit)</td> </tr> <tr> <td>ACCY1</td> <td>30 amp</td> <td>Fused 12 volt ACCESSORY feed (may also be used to feed power to an accessory circuit)</td> </tr> </tbody> </table>	Fuse	Rating		FUEL	15 amp	Fused 12 volt IGNITION feed for fuel pump (may also be used to feed power to another ignition circuit)	BAT1	20 amp	Fused 12 volt BATTERY feed for power seats (may also be used to feed power to another battery circuit)	BAT2	30 amp	Fused 12 volt BATTERY feed for power door locks (may also be used to feed power to another accessory circuit)	IGN1	20 amp	Fused 12 volt IGNITION feed for cruise control (may also be used to feed power to another ignition circuit)	PWRWDO	30 amp	Fused 12 volt IGNITION feed for power windows (may also be used to feed power to another ignition circuit)	ACCY1	30 amp	Fused 12 volt ACCESSORY feed (may also be used to feed power to an accessory circuit)
Fuse	Rating																							
FUEL	15 amp	Fused 12 volt IGNITION feed for fuel pump (may also be used to feed power to another ignition circuit)																						
BAT1	20 amp	Fused 12 volt BATTERY feed for power seats (may also be used to feed power to another battery circuit)																						
BAT2	30 amp	Fused 12 volt BATTERY feed for power door locks (may also be used to feed power to another accessory circuit)																						
IGN1	20 amp	Fused 12 volt IGNITION feed for cruise control (may also be used to feed power to another ignition circuit)																						
PWRWDO	30 amp	Fused 12 volt IGNITION feed for power windows (may also be used to feed power to another ignition circuit)																						
ACCY1	30 amp	Fused 12 volt ACCESSORY feed (may also be used to feed power to an accessory circuit)																						
3	DIMMER SWITCH	Yellow Light Green Tan	This connector will mate to the floor mounted dimmer switch. 12 volt feed into dimmer switch from H/L switch 12 volt feed out to high beam H/L 12 volt feed out to low beam H/L																					
4	REAR BODY	Tan Brown Yellow Dark Green Orange White Light Green Light Blue	This connector will mate with the connector from the Rear Body harness 510222, bag M. Fuel tank sender lead Tail lamp and tag lamp feed LH turn / brake feed RH turn / brake feed Dome / courtesy lamp feed Dome / courtesy lamp ground Back up lamp feed Third brake light																					
5	HORN RELAY	Red Black Dark Green	Plug the horn relay (found in the fuse, relay, and flasher bag, 500707) into this connector. 12 volt battery for relay Relay ground circuit (from steering column) Triggered 12 volts out to horn																					
6	LH INSTRUMENT CLUSTER DISCONNECT		This connector will plug into the the Intrument Cluster Harness, 510223, bag H. Circuit identifications for this branch are described in those instructions.																					
7	HEADLIGHT SWITCH	Red Orange Brown Yellow Dark Green White	This connection will plug onto the new headlamp switch, 500332. Battery 12 volt input lead to switch for headlamps. Battery fused 12 volt input lead to switch for park / tail output and dash lamp input Park/tail lamp output 12 volt output lead to dimmer switch for headlamps Dash lamp output to fuse panel Dome / Courtesy ground																					
8	STEERING COLUMN CONNECTION	Gray Black	Transmission selector lamp wire for column automatic cars Horn relay ground wire for stock 59-60 column. If using a late model column, cut the end off of your stock wire, crimp on terminal M and plug into connector L as seen above																					
9	TURN SIGNAL SWITCH	White Dark Green Yellow Purple Brown Dark Blue Light Blue Black	The connector on this harness will mate directly to the 3 7/8" turn signal switch used by GM and many other aftermarket steering column manufacturers. If you are using a stock 1959-60 column and turn signal switch that is mounted on top of the column up under the dash, an adapter has been provided for you. Simply take the adapter and crimp terminals M onto each wire from the adapter and install those terminals into connector L as shown above right in "Diagram A". If you are using an aftermarket column that utilizes the 4 1/4" column connection, removed the terminals from that connector or cut the connector off and crimp terminals M onto the wires from your switch, then install the terminals into connector L maintaining color continuity with the new switch. to 12 volt feed from brake swit RH rear stop and turn LH rear stop and turn 12 volt ignition feed from turn signal flasher 12 volt battery feed from hazard flasher RH front turn LH front turn Horn relay ground to horn switch																					

NOTE: There are 2 round vinyl plugs enclosed in the loose piece parts package of this dash harness kit. They are to be installed into your original firewall engine and forward lamp harness pass thru holes. They will fit firmly into the original holes with no modification necessary.



www.americanautowire.com 856-933-0801

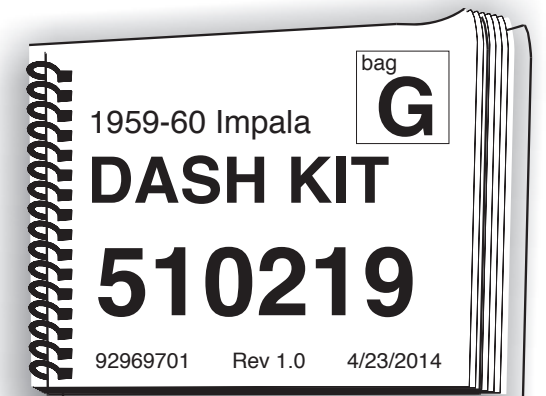

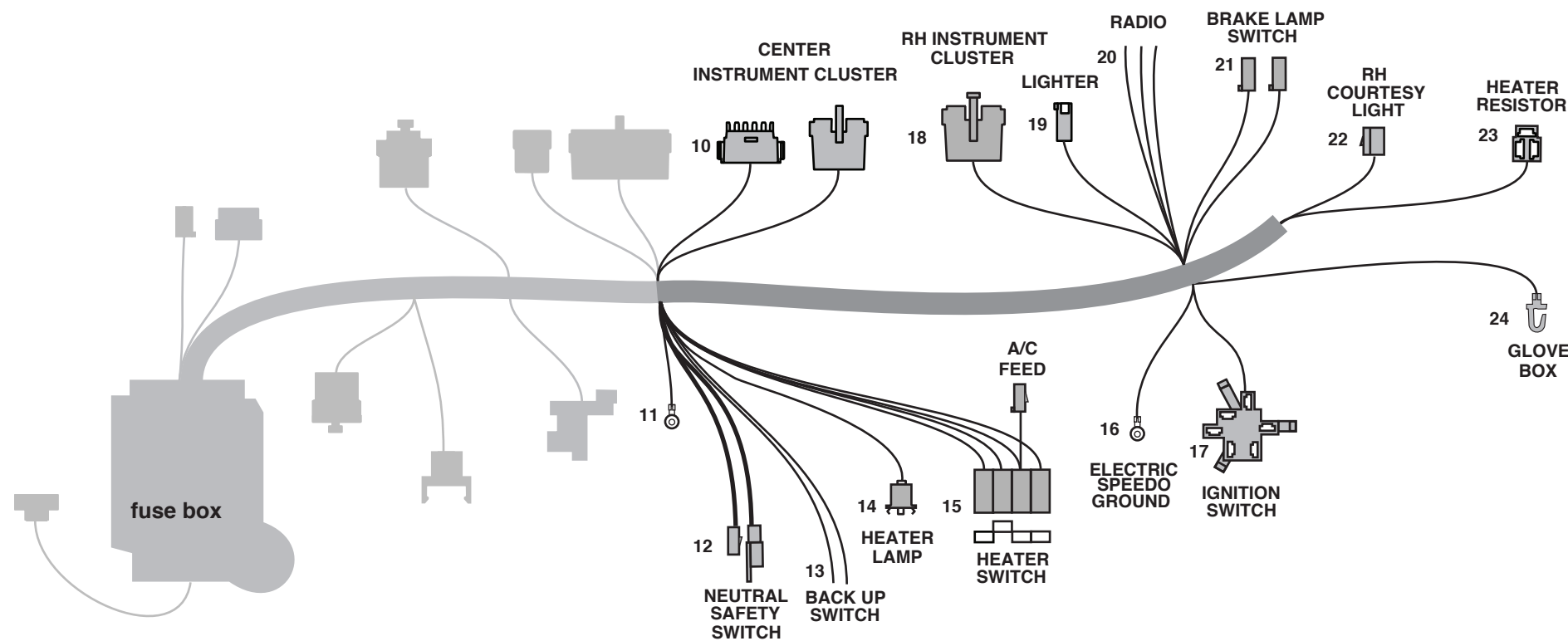

NOTE: For your information, there were 7 different windshield wiper and washer configurations that Chevrolet used between 1959 and 1960. This kit supplies the main power feed for those systems just as your stock dash harness did. This feed, which is found in the engine harness, 510220, bag J, will plug directly into your existing wiper harness or motor assembly exactly as the original did. If you require a new wiper harness for your car, they are available from AAW. Contact our Sales Department at 856-933-0801 or your favorite dealer to inquire about the correct application for your car.

- | | | | |
|----|---------------------------------------|-------------|---|
| 10 | CENTER INSTRUMENT CLUSTER DISCONNECTS | | These connectors will plug into the the Intrument Cluster Harness, 510223, bag H. Circuit identifications for this branch are described in those instructions. |
| 11 | GROUND | | Connect to the dash frame, steering column saddle, or any other good known chassis ground. |
| 12 | NEUTRAL SAFETY SWITCH | Black | Cluster and dash lamp grounds |
| | | Purple | Connect these wires to your neutral safety switch or together if you are using a manual transmission without an NSS. |
| | | Purple | 12 volt feed in from ignition switch |
| 13 | BACK UP LAMP SWITCH | | Switched 12 volt feed out to starter solenoid |
| | | Light Green | Connect these wires to your back up lamp switch. |
| | | Pink | 12 volt feed out to back up lamps |
| 14 | HEATER CONTROL LAMP | Gray | 12 volt ignition feed into back up lamp switch |
| 15 | HEATER SWITCH | | Dash lamp feed |
| | | Brown | Plug this connector onto your stock heater control switch |
| | | Yellow | 12 volt fused switch feed for heat or A/C power. (if using aftermarket A/C, use the short pigtail wire as the switched "ON" "OFF" feed wire to the aftermarket A/C harness.) |
| | | Light Blue | To heater resistor |
| | | Orange | To heater resistor |
| 16 | ELECTRIC SPEEDO GROUND | | To heater resistor and blower motor |
| | | | Connect to the dash frame, steering column or pedal saddle, or any other good known chassis ground. (DO NOT attach this together with item #11 from above. They may be grounded to the same surface or area, just not under the same screw or bolt) |
| 17 | IGNITION SWITCH | Black | Electric speedo ground |
| | | | This connection will plug onto the new ignition switch, 500684. |
| | | Red | 12 volt battery feed |
| | | Pink | 12 volt ignition feed |
| | | Brown | 12 volt accessory feed |
| | | Purple | 12 volt starter feed to Neutral Safety Switch |
| 18 | RH INSTRUMENT CLUSTER DISCONNECT | | This connector will plug into the the Intrument Cluster Harness, 510223, bag H. Circuit identifications for this branch are described in those instructions. |
| 19 | LIGHTER | Orange | 12 volt fused battery feed to lighter |
| 20 | RADIO | Tan | 12 volt accessory power feed to radio ("ON" and "OFF") |
| | | Yellow | 12 volt fused battery feed for clock and memory |
| | | Gray | Radio lamp wire for stock 1959-1960 radio application |
| 21 | BRAKE LIGHT SWITCH | | Plug this connector onto your factory stop lamp switch. |
| | | Orange | 12 volt fused battery feed to stop lamp switch |
| | | White | 12 volt out to turn signal switch |
| | | Light Blue | 12 volt out to third brake lamp |
| 22 | RH COURTESY LAMP | | Plug this connector into the mating RH courtesy lamp assembly from 500471, bag N. |
| | | Orange | 12 volt battery fused feed |
| | | White | Courtesy lamp switched ground |
| 23 | HEATER RESISTOR | | (Used on stock non A/C equipped cars only) Plug this connector onto the stock heater resistor located on the stock heater box inside the car under the dash. |
| 24 | GLOVEBOX LAMP | Orange | 12 volt fused battery feed for glovebox lamp |



www.americanautowire.com 856-933-0801

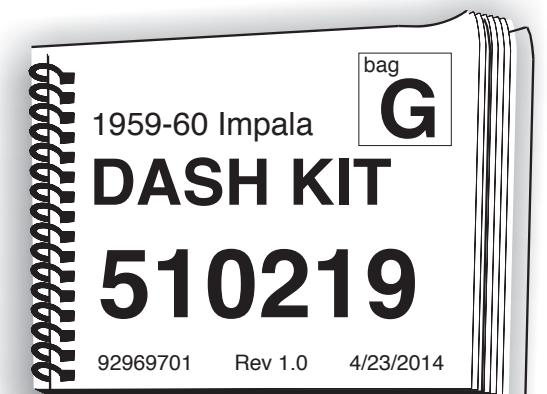

THIS PAGE HAS INTENTIONALLY BEEN LEFT BLANK



www.americanautowire.com 856-933-0801

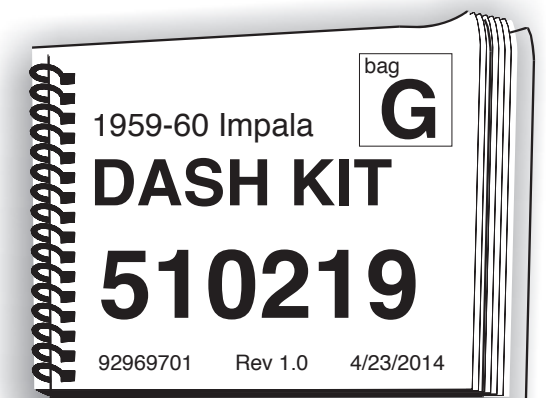

*** These are special instructions for connecting your wiring system to a stock instrument cluster. ***

Note: If you are using after market gauges, follow the instructions included in the 92965220 Gauge Connection Kit along with the specific gauge manufacturers instructions for connection of their gauges.

If you are using the stock gauges and warning lamps, refer to the diagrams on the following pages for your application. Use the enclosed parts and information below for wire termination, gauge, and lamp connections. Connectors A,B,C, and D will plug into your dash harness at locations 6, 10, and 18 as noted on the Dash Harness instruction (510219, bag G) sheet. Connection C will only be used in the event that you are using an electric speedometer.

CONNECTOR A (sheet 2)

TAN	Brake Warning Lamp	Install components shown on the following sheets, and plug into the brake warning lamp hole in cluster.
DK BLUE	Oil Gauge / Lamp	Install components shown on the following sheets, and plug onto the oil gauge or into the warning lamp hole in cluster.
DK GREEN	Temp Gauge / Lamp	Install components shown on the following sheets, and plug onto the temperature gauge.
BROWN	Generator Lamp	This wire is used on warning lamp applications only. This wire is stamped "ALT-IGN". Plug loose wire into Connector A maintaining color continuity with the mating connector on your dash harness, install components shown on the following sheets, and plug into the generator (alternator) warning lamp hole in cluster.
PINK	12v ignition	Install components shown on the following sheets, and connect to proper gauges or warning lights requiring a 12v ignition feed.
GREY	Instrument Lamps	Install components shown on the following sheets, and plug into the instrument lamp holes in the cluster.
BLACK	Ground	Connect to the back of the LH instrument cluster housing.

CONNECTOR B (sheet 3)

DK BLUE	Right Turn Indicator	Install components shown on the following sheets, and plug into the right turn hole in cluster.
LT BLUE	Left Turn Indicator	Install components shown on the following sheets, and plug into the left turn hole in cluster.
LT GREEN	Hi Beam Indicator Lamp	Install components shown on the following sheets, and plug into the high beam hole in cluster.
PINK	12v ignition	Install components shown on the following sheets, and connect to tach 12v ignition feed.
GREY	Instrument Lamps	Install components shown on the following sheets, and plug into the instrument lamp holes in the cluster and tach as needed.
BLACK	Ground	Connect to the back of the speedometer cluster housing and tach as needed.
WHITE	Tach (loose wire)	If your car is equipped with a tach, plug this loose wire into Connector B maintaining color continuity with the mating connector on your dash harness, install components shown on the following sheets, and plug onto the tachometer.

CONNECTOR C (sheet4)

This connector is used when using an aftermarket electronic speedometer only. Follow the manufacturer's instructions when installing these wires. If you are using the stock speedometer, then discard this connector. See page 4 for wire descriptions and typical connections.

CONNECTOR D (sheet4)

TAN	Fuel Gauge	Install components shown on the following sheets, and plug onto the fuel gauge.
YELLOW	Clock Battery Feed	If your car is equipped with a clock, plug this loose wire into Connector D maintaining color continuity with the mating connector on your dash harness, install components shown on the following sheets, and plug onto the clock assembly.
PINK	12v ignition	Install components shown on the following sheets, and connect to proper gauges or warning lights requiring a 12v ignition feed.
GREY	Instrument Lamps	Install components shown on the following sheets, and plug into the instrument lamp holes in the cluster.
BLACK	Ground	Connect to the back of the RH instrument cluster housing.



**American
Autowire**

www.ameriacnautowire.com 856-933-0801

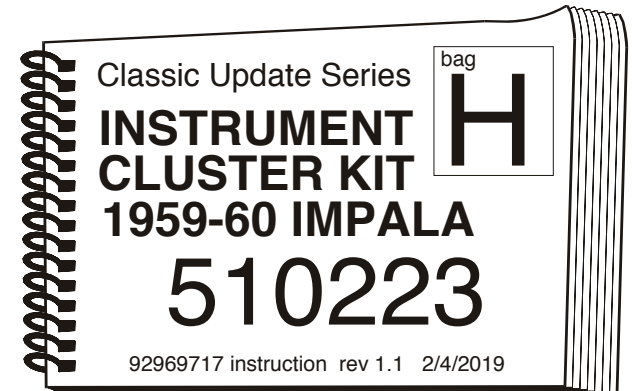

Classic Update Series

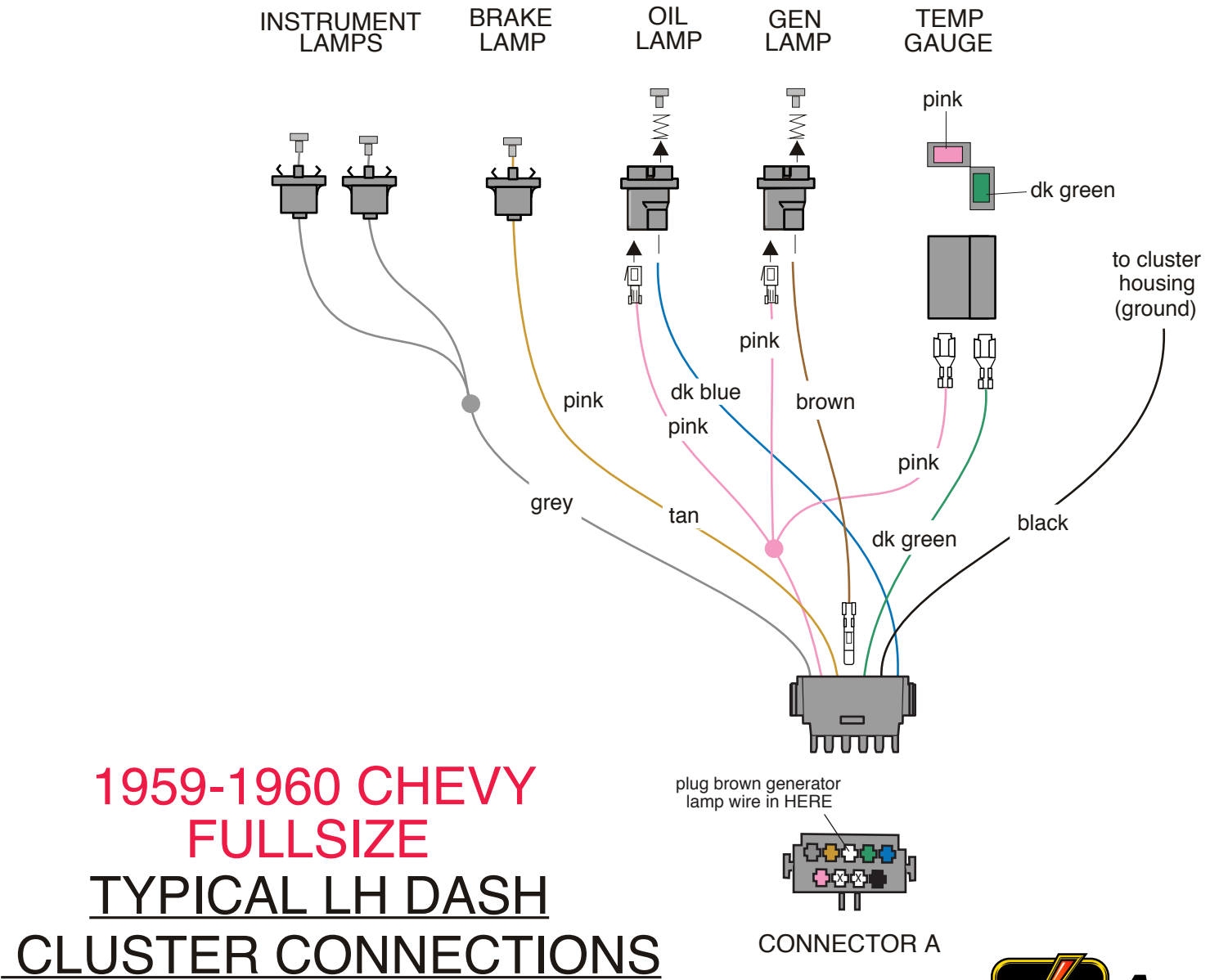

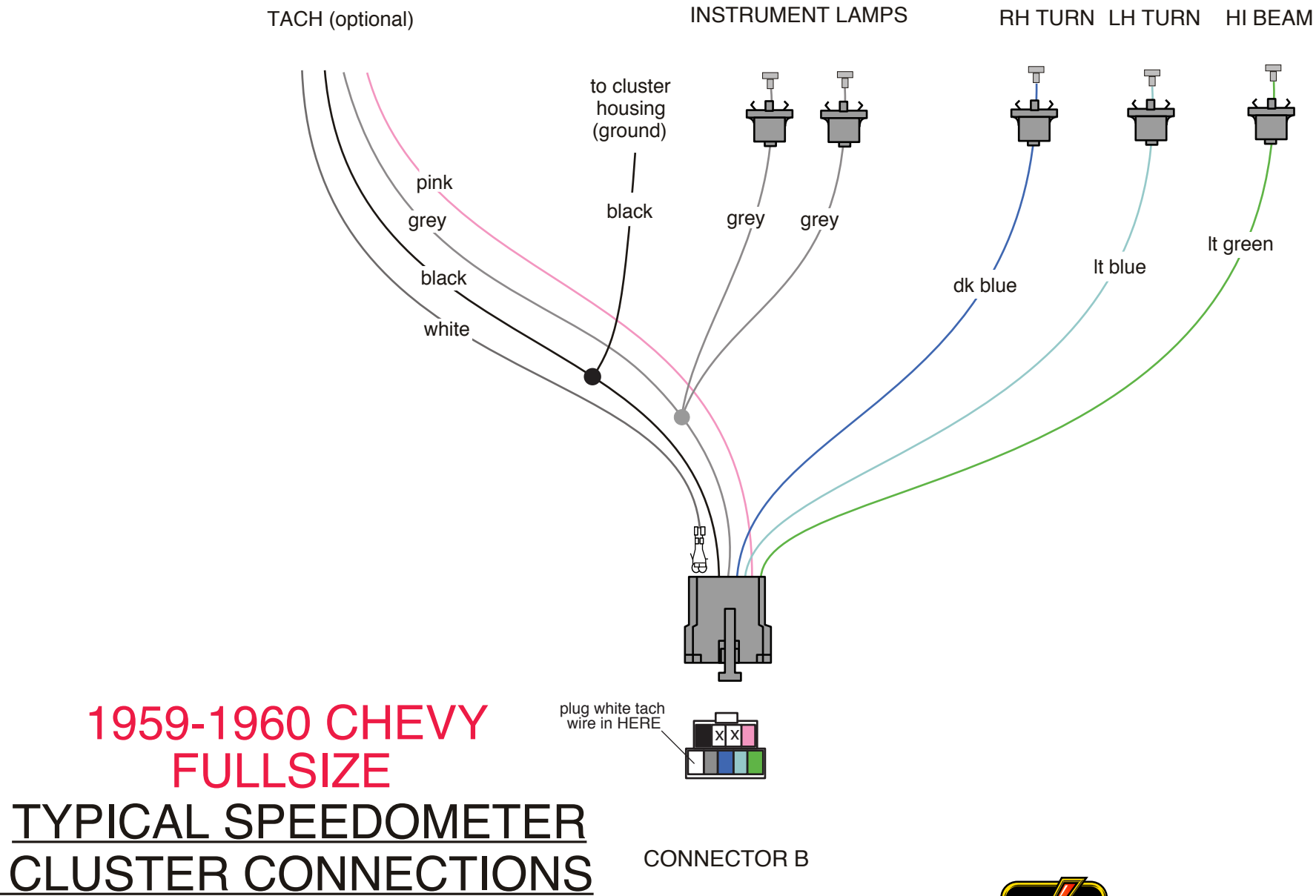

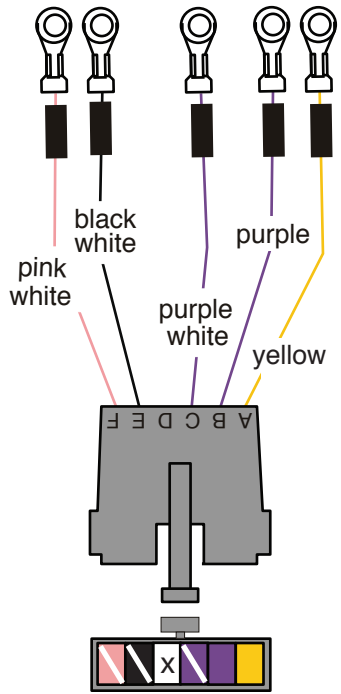

CONNECTOR C

TYPICAL ELECTRIC SPEEDO CONNECTIONS

Below are some general instructions for hooking up an electric speedometer. This connector and these instructions will ONLY be used in the event that you are utilizing an aftermarket electric speedometer. If your car does NOT have an electric speedometer, this connection will NOT be used and should not be plugged onto your dash harness. It is best to consult the speedometer manufacturer's instructions if you have any questions.

<u>Yellow</u>	VSS Ground	Connect to VSS "-" on speedometer.
<u>Purple</u>	VSS Pulse	Connect to VSS input on speedometer.
<u>Purple/White</u>	VSS Power	Connect to 12V power on speedometer.
<u>Black/White</u>	Speedo Ground	Connect to ground on speedometer.
<u>Pink/White</u>	Speedo Power	Connect to 12v power on speedometer. NOTE: This wire will double onto the same stud as the purple/white VSS power wire from above.

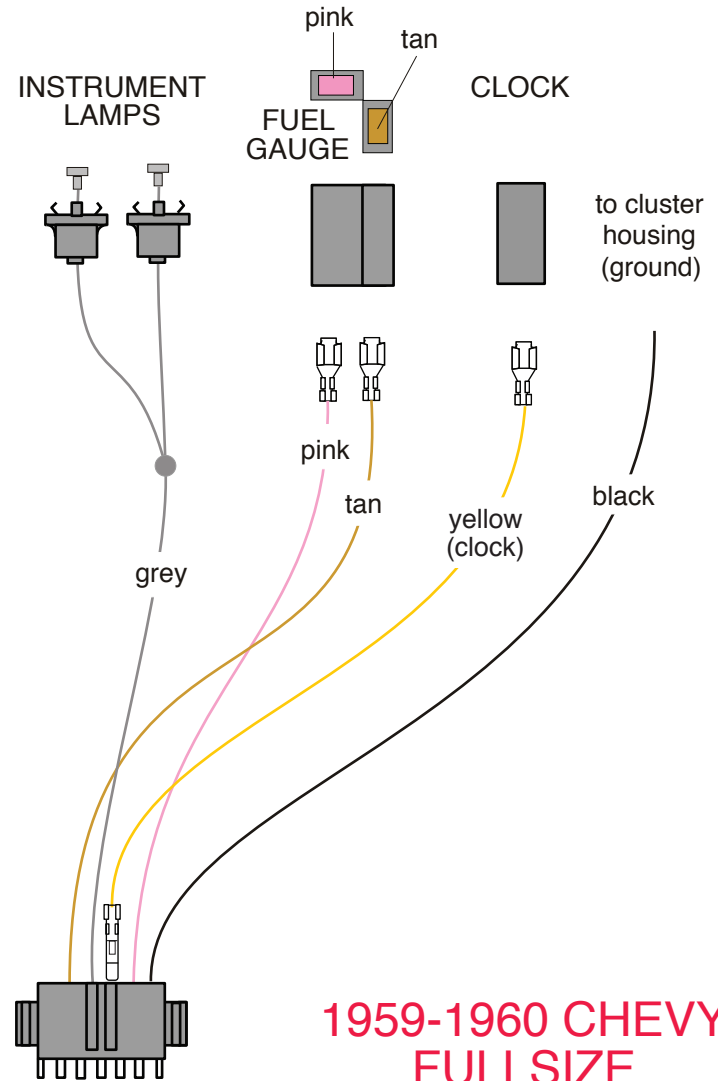

CONNECTOR D

1959-1960 CHEVY FULLSIZE TYPICAL RH DASH CLUSTER CONNECTIONS



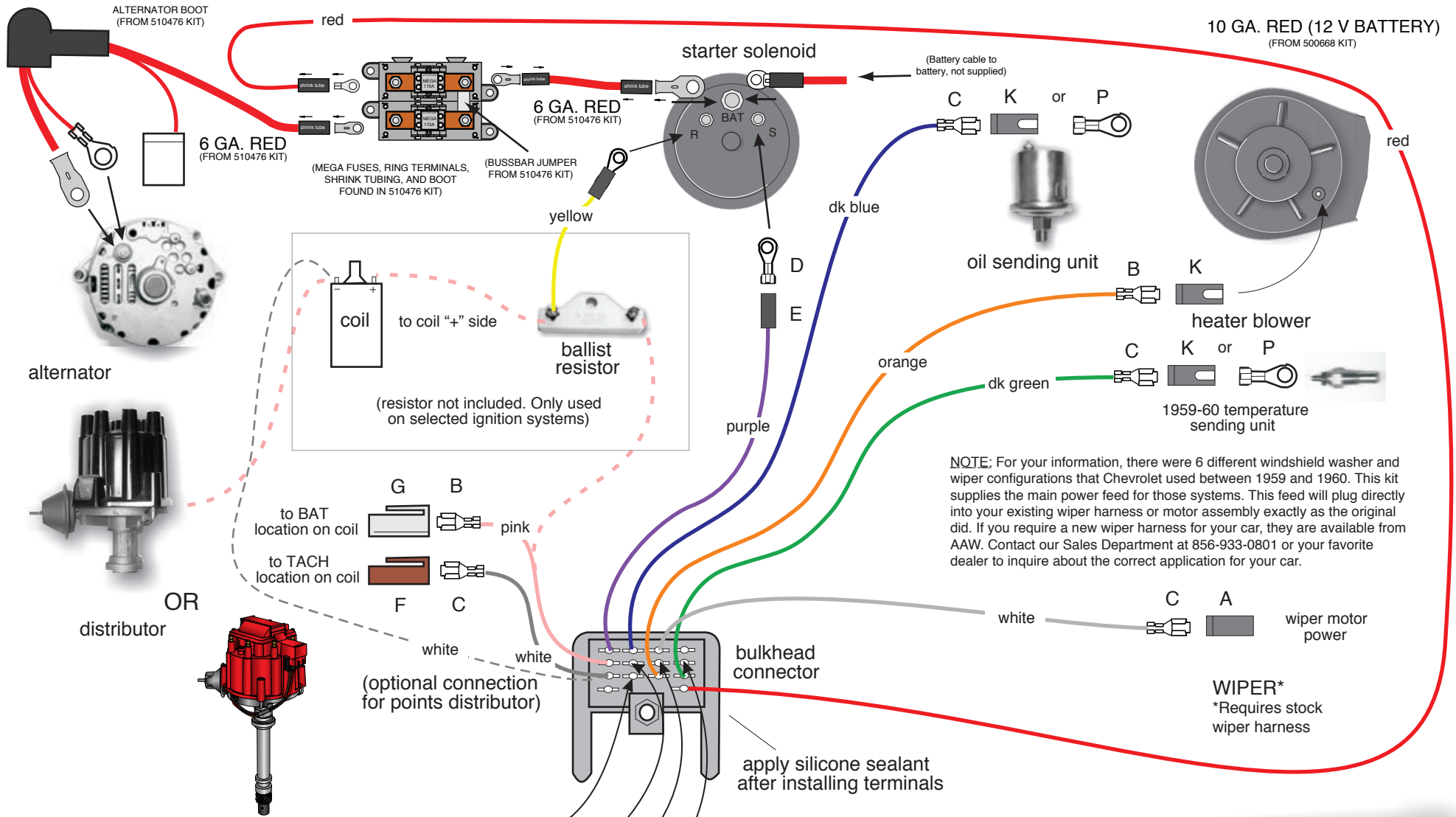

**American
Autowire**

www.americanautowire.com 856-933-0801

Classic Update Series

1959-60
Impala

ENGINE KIT

510220

92969705 instruction rev 1.0 1/12/2018

bag **J**

TEMPORARILY, PLUG THE MAIN BULKHEAD CONNECTOR FROM THIS KIT INTO THE MATING CONNECTOR ON THE DASH BULKHEAD CONNECTOR (LOCATED UNDER THE MASTER CYLINDER) Note: This will be unbolted to install the front light harness later.

BULKHEAD CONNECTOR WIRES:

- | | | |
|--------------------|-----------------------|---|
| RED | (12 V BATTERY) | Route this wire to the Megafuse and cut to length. Use ring terminal, shrink tubing from 510476 kit. Connect as shown on page 1. |
| PURPLE | (STARTER SOLENOID) | Route to the starter solenoid and cut to length. Install rubber sleeve E and ring terminal D. Connect to the "S" terminal on the solenoid. |
| DARK BLUE | (OIL PRESSURE SENDER) | Connect this wire to the oil pressure sending unit using terminal P or terminal C together with connector K. |
| DARK GREEN | (TEMPERATURE SENDER) | Connect this wire to the temperature sending unit using terminal P or terminal C together with connector K. |
| ORANGE | (HEAT / AIR) | If using stock or after-market air conditioning, remove this wire. If using a stock heater only system, route this wire to the heater blower motor, cut to length, install terminal B and connector K. |
| PINK | (12 V IGNITION) | If using an HEI distributor or after-market ignition system which requires a 12 volt feed:
Route the PINK wire to the coil and trim to length. Install terminal C and connector G, and plug into the distributor cap BAT location.
If using a points type ignition system which requires reduced voltage:
Route the PINK wire to the ignition feed side of a ballast resistor (not included). Connect a piece of left over PINK wire to the coil side of the ballast resistor and route to the distributor coil positive (+) side. |
| YELLOW | | (Used only with a points style ignition) Connect the loose piece YELLOW wire to the R terminal on the starter and connect the other end to the coil side of the ballast resistor (not included) using terminal P. |
| WHITE | (COIL-TACH) | Route this wire to the coil and trim to length. If using an HEI distributor, terminal C and connector F are included for connection to the TACH location. If using a conventional coil, terminal P is included for connection to the negative (-) side of the coil. |
| WHITE | (WIPER 12 VOLT FEED) | Route this wire to the wiper motor, trim to length, install terminal C and plug into connector A. |
| ALTERNATOR: | | |
| HEAVY RED | (AMERICAN AUTOWIRE) | Use the 6ga red wire, boot, and ring terminal from the 510476, route from alternator to the Megafuse and cut to length. Connect as shown on page 1 of this instruction set and on the 92972153 (510476) instruction set. |
| SMALL RED | | Send the ring terminal end of this wire through boot (as shown on sheet 1) and connect to the battery stud on the alternator. Do not plug the connector into the alternator yet. The brown exciter wire will need to be added to this connector when the front light harness wires are installed. |

REMAINING LOOSE WIRES: These wires will be used only if you are using an electronic speedometer or an electric choke. Plug them into the main engine connector as shown on page 1 of this instruction sheet and route them as outlined below.

- | | | |
|--------------|-----------------|---|
| PURPLE/WHITE | (POWER) | Route this wire to the vehicle speed sensor and connect to the 12 volt power lead. |
| PURPLE | (SIGNAL) | Route this wire to the vehicle speed sensor and connect to the signal lead. |
| YELLOW | (GROUND) | Twist this wire with the purple signal lead wire above to assure proper shielding. Connect this wire to the vehicle speed sensor ground lead. |
| PINK | (12 V IGNITION) | If using an electric choke (or some other accessory that requires a 12 volt keyed ignition feed), route this wire to your carburetor choke assembly (or other appliance), cut to length, and connect there. No terminals have been supplied for this connection as they vary greatly from assembly to assembly. |

Once the main connector has had all of it's wires plugged in, the connector cavities should be sealed with dielectric grease on the terminals. Also, to assure a moisture resistant seal, silicone can be applied to seal the outside of the connector.

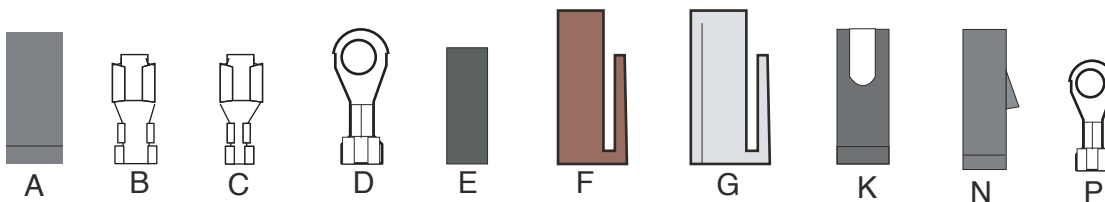

ENGINE KIT
510220

Classic Update Series

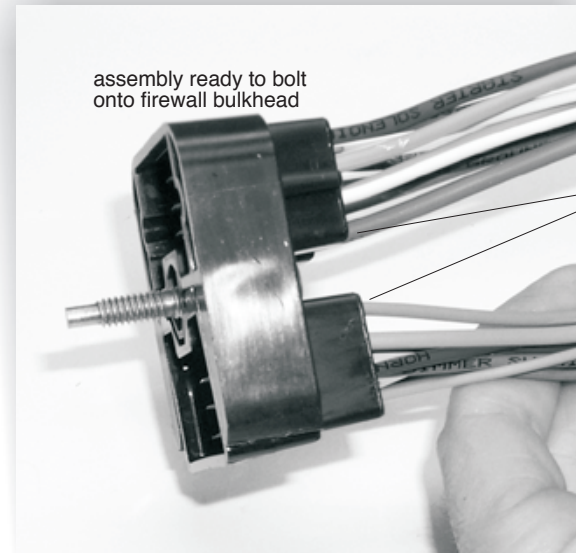
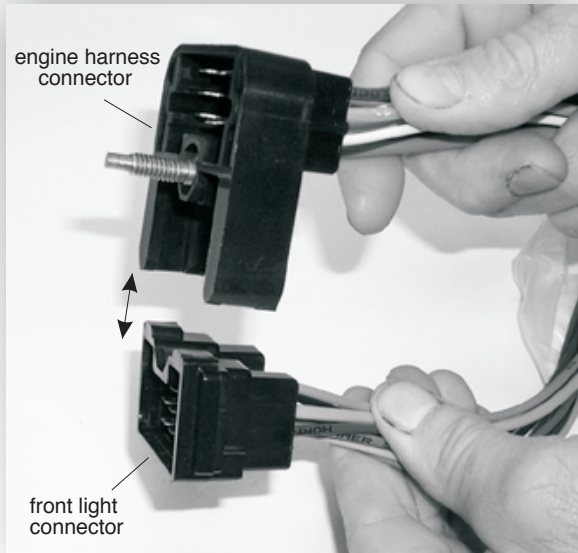

The bulkhead connector from this front light kit must snap into the mating engine connector (bag J), as shown. After snapping together, then bolt the assembly into the dash harness firewall connector using the attached bolt.

Look!



**American
Autowire**

www.americanautowire.com 856-933-0801

American Autowire also sells factory OEM style harness wrap tape. This is the same stuff used on original GM harnesses! If you want that OEM look with your Classic Update wiring system, then give us a call and order our P/N R0067108!



Classic Update Series

right headlights

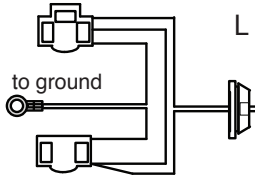

L

right H/L connection

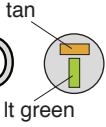

tan

lt green

H

D

D

tan

lt green

to electric fan

orange

recommended fan relay (not included in this kit)

to horn

K

E

dk green

to horn

K

D

lt green

tan

bulkhead connector

connect to brake pressure sending unit if needed (not included in kit)

tan

left headlights

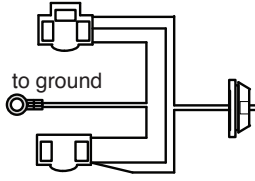

L

left H/L connection

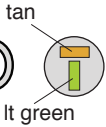

tan

lt green

H

E

E

dk blue

brown

lt blue

brown

apply silicone sealant to back side of connector after installing terminals

right turn signal

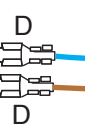
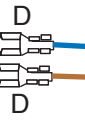

dk blue

brown

G

D

D

D

D

D

D

D

D

D

D

D

D

D

D

lt blue

brown

G

D

D

D

D

D

D

D

D

D

D

D

D

D

left turn signal

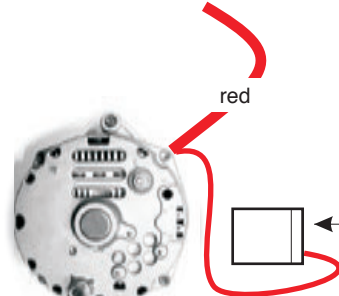

red

D

brown

alternator

1959 Impala Front Light

1959 IMPALA

Snap together the bulkhead connector from this kit and the bulkhead connector from the engine kit (bag J) then bolt them to the firewall dash bulkhead. After all wires are installed from this kit, the main connector should have die-electric grease applied to the terminals and silicone sealer applied to the outside of the connectors as a moisture seal.



PARKING LAMP WIRES:

LT BLUE LH turn

Route this wire to the LH turn signal lamp connection in the LH inner fender panel, cut to length, install terminal D and plug into connector G in the location shown on sheet 2.



DK BLUE RH turn

Route this wire to the RH turn signal lamp connection in the RH inner fender panel, cut to length, install terminal D and plug into connector G in the location shown on sheet 2.

BROWN Parking Lamp

Route the shorter brown wire that is the same length as the light blue wire to the LH turn signal lamp connection in the LH inner fender panel, cut to length, install terminal D and plug into connector G in the location shown on sheet 2. Route the longer brown wire that is the same length as the dark blue wire to the RH turn signal lamp connection in the RH inner fender panel, cut to length, install terminal D and plug into connector G in the location shown on sheet 2.



FRONT LIGHT WIRING:



All 59 Chevrolet models utilized a special headlamp bucket harness assembly. You will find 2 of these harness assemblies L in your front lighting kit. Install them thru your factory headlight buckets, ground them to the inside of the bucket assembly as original using the provided ring terminal, and install the molded end into the LH and RH inner fender panels. The following front light connections that you are about to create will plug into these molded ends at the inner fender panels completing the headlamp connections.



TAN (heavy gauge) Lo Beam

Route this wire to the driver side LH headlight connection in the LH inner fender panel, cut to length, double this wire with the cutoff portion, install terminal E, and plug this terminal into connector H in the location shown on sheet 2. Route the remaining portion of this TAN wire to the passenger side RH headlight connection in the RH inner fender panel, cut to length, install terminal D, and plug this terminal into connector H in the location shown on sheet 2.

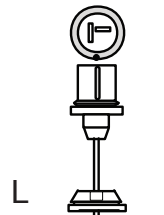

LT GREEN Hi Beam

Route this wire to the driver side LH headlight connection in the LH inner fender panel, cut to length, double this wire with the cutoff portion, install terminal E, and plug this terminal into connector H in the location shown on sheet 2. Route the remaining portion of this LT GREEN wire to the passenger side RH headlight connection in the RH inner fender panel, cut to length, install terminal D, and plug this terminal into connector H in the location shown on sheet 2.

OTHER WIRING:

DK GREEN Horn

Route to horns, cut to length, install terminals D & E, and plug into connectors L as shown on sheet 2.

ORANGE Electric Fan

Route to electric fan or relay and connect per the manufacturer's instructions.

NOTE: We recommend that this wire be used as the trigger wire only for the electric fan relay.

TAN (small gauge) Brake Light/ Switch

If your car is equipped with a brake warning system, plug this wire into the main connector as shown on sheet 2 and splice the other end onto your brake sender switch connection (brake switch connection not included in kit).

BROWN Alternator Regulator

Route this wire to the alternator and cut to length. Install terminal D and plug into the regulator connector (previously installed from the engine kit 510066 bag J) as shown on sheet 2. (Not used with 1 wire alternator)

Classic Update Series

right headlights

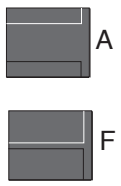

left headlights

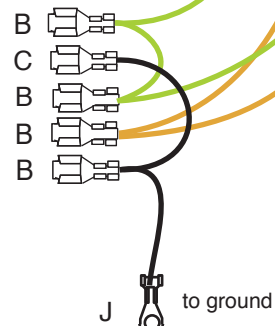
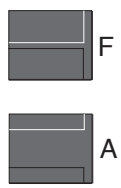

right turn signal

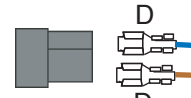
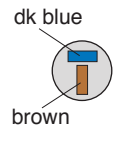

left turn signal

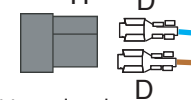
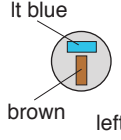

existing red wires from engine kit bag J

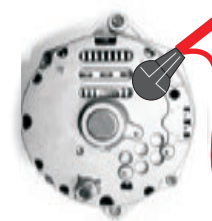

alternator

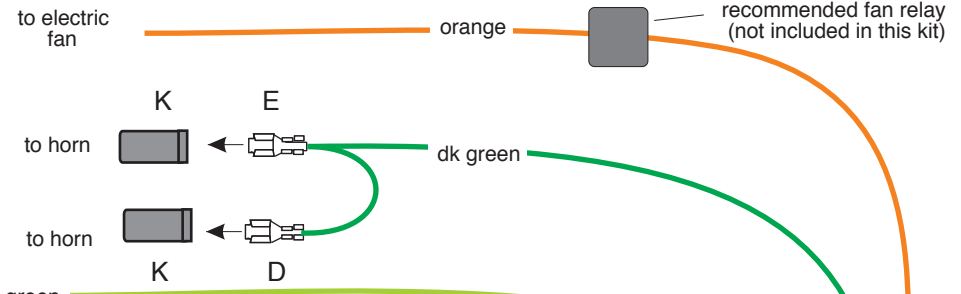

connect to brake pressure sending unit if needed (not included in kit)

recommended fan relay (not included in this kit)

bulkhead connector

apply silicone sealant to back side of connector after installing terminals

1960 Impala Front Light

1960 IMPALA

Snap together the bulkhead connector from this kit and the bulkhead connector from the engine kit (bag J) then bolt them to the firewall dash bulkhead. After all wires are installed from this kit, the main connector should have die-electric grease applied to the terminals and silicone sealer applied to the outside of the connectors as a moisture seal.



PARKING LAMP WIRES:

LT BLUE	LH turn
DK BLUE	RH turn
BROWN	Parking Lamp

Route this wire to the LH turn signal lamp connection in the LH inner fender panel, cut to length, install terminal D and plug into connector G in the location shown on sheet 4.

Route this wire to the RH turn signal lamp connection in the RH inner fender panel, cut to length, install terminal D and plug into connector G in the location shown on sheet 4.

Route the shorter brown wire that is the same length as the light blue wire to the LH turn signal lamp connection in the LH inner fender panel, cut to length, install terminal D and plug into connector G in the location shown on sheet 4. Route the longer brown wire that is the same length as the dark blue wire to the RH turn signal lamp connection in the RH inner fender panel, cut to length, install terminal D and plug into connector G in the location shown on sheet 4.

FRONT LIGHT WIRING:

TAN (heavy gauge)	Lo Beam
LT GREEN	Hi Beam

Route this wire to the driver side outer headlight, trim to length, double this wire with the cutoff portion, install terminal B and plug into connector A in the location shown on sheet 4. Route the remaining portion of this TAN wire to the passenger side outer headlight, trim to length, install terminal C and plug into connector A as shown on sheet 4.

Route this wire to the driver side outer headlight, trim to length, double this wire with the cutoff portion, install terminal B, plug this terminal into connector A, make a short jumper over to the driver side inner headlight, cut to length, double it with the cutoff portion, install terminal B, and plug it into connector F in the location shown on sheet 4. Route the remaining portion of this LT GREEN wire to the passenger side inner headlight, trim to length, double this wire with the cutoff portion, install terminal B, plug into connector F, make a short jumper over to the passenger side outer headlight, cut to length, double it with the cutoff portion, install terminal C, and plug it into connector A in the location shown on sheet 4.

BLACK	Ground
-------	--------

Attach the ring terminal to a good chassis ground then route this wire to the driver side outer headlight, trim to length, double this wire with the cutoff portion, install terminal B and plug this terminal into connector A. Route the remaining portion of this BLACK wire over to the driver side inner headlight, cut to length, install terminal C, and plug it into connector F in the location shown on sheet 4. Repeat this process for the passenger side.

OTHER WIRING:

DK GREEN	Horn
ORANGE	Electric Fan
TAN (small gauge)	Brake Light/ Switch
BROWN	Alternator Regulator

Route to horns, cut to length, install terminals D & E, and lug into connectors L as shown on sheet 4.

Route to electric fan or relay and connect per the manufacturer's instructions.

NOTE: We recommend that this wire be used as the trigger wire only for the electric fan relay.

If your car is equipped with a brake warning system, plug this wire into the main connector as shown on sheet 4 and splice the other end onto your brake sender switch connection (brake switch connection not included in kit).

Route this wire to the alternator and cut to length. Install terminal D and plug into the regulator connector (previously installed from the engine kit 510066 bag J) as shown on sheet 2. (Not used with 1 wire alternator)

This page intentionally left blank

Classic Update Series

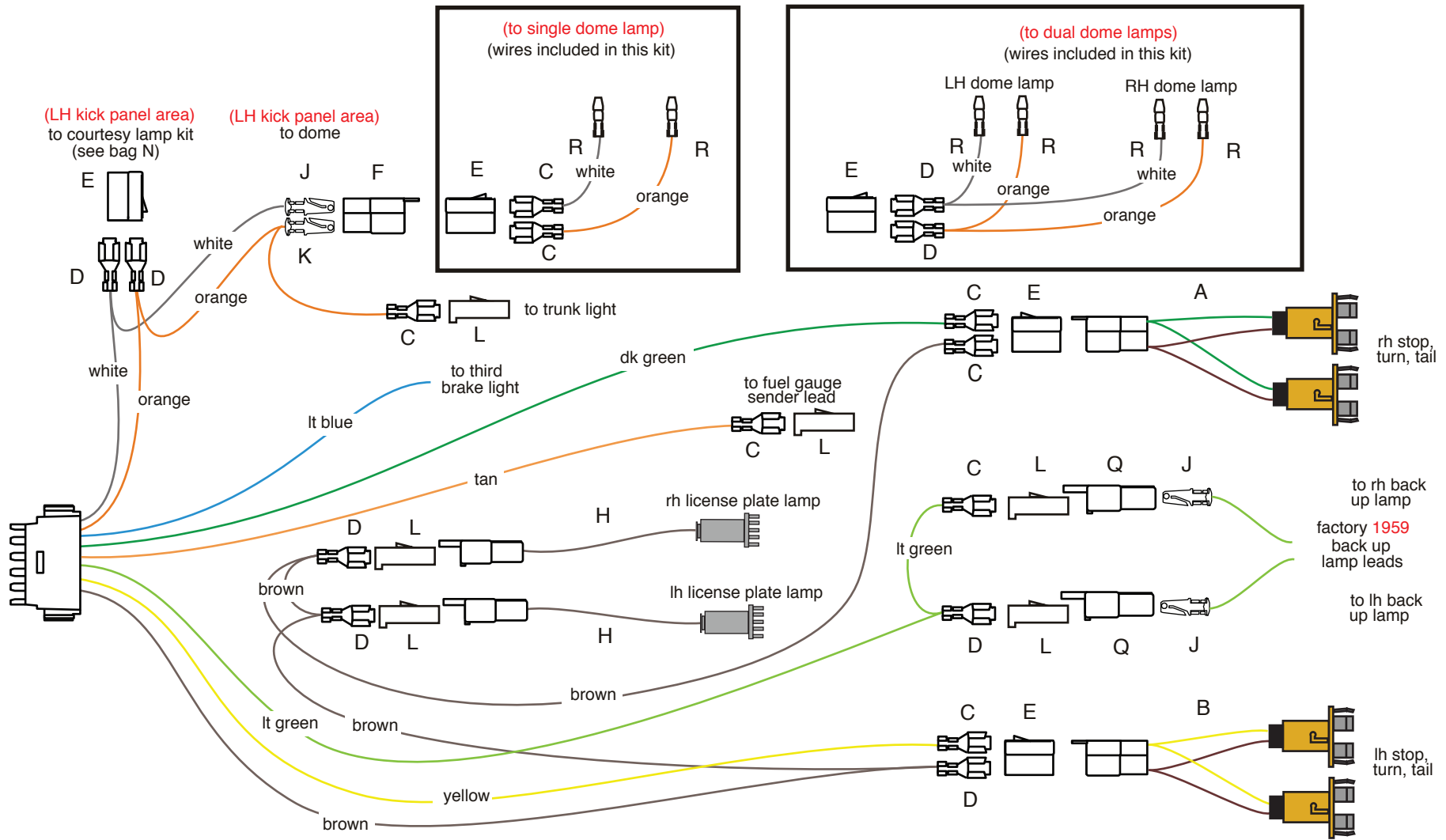

1959 Impala, Bel Air and Biscayne



www.americanautowire.com 856-933-0801

Classic Update Series **bag M**
 1959-60 Impala
 REAR BODY KIT
510222
 92969713 instruction rev 0.0 2/3/2011

1959 Impala, Bel Air, and Biscayne (See sheet 1)

Connect the main connector to the mating connector on the dash harness 510219 bag G. Route this harness down the driver's door sill & into the trunk.

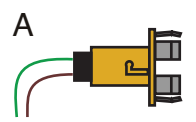

LIGHT BLUE
TAN

Third brake light
Fuel Tank Sender

Connect to the third brake lamp, if equipped.

Route this wire to the rear of the car close to the exit hole in the trunk floor then down to the fuel tank sender, install terminal C and connector L onto the wire, then plug the assembled connector lead onto the sending unit to complete the fuel tank sender connection.

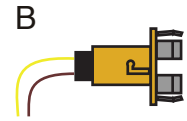

BROWN

Running lamps

Note: Two new license lamp leads H have been provided for you. Plug these onto connectors L in the following rear body assembly instructions to complete your two license lamp connections. New Stop/Tail lamp pigtails B and A (yellow and brown for LH driver's side, and green and brown for RH passenger's side) have been provided for you as well. Simply plug them onto connectors E in the following assembly instructions to complete your stop and tail lamp connections.

Route this wire to the LH tail lamp, cut to length, double this wire with the cut off portion, install terminal D and plug into connector E in the location shown on sheet 1. Route the loose end of this brown wire to the LH license lamp area, cut to length, double this wire with the cut off portion, install terminal D and plug into connector L as shown on sheet 1. Route the loose end of this brown wire to the RH license lamp area, cut to length, double this wire with the cut off portion, install terminal D and plug into connector L as shown on sheet 1. Route the loose end of this brown wire to the RH tail lamp area, cut to length, install terminal C and plug into connector E in the location shown on sheet 1.



YELLOW

LH Stop / Tail

Route this wire to the LH tail lamp area, cut to length, install terminal C and plug into the empty cavity of connector E as shown on sheet 1. Plug LH pigtail B (yellow and brown wires) from above onto this connection to complete the LH stop, turn, and tail circuits.



DK GREEN

RH Stop / Tail

Route this wire to the RH tail lamp area, cut to length, install terminal C and plug into the empty cavity of connector E as shown on sheet 1. Plug RH pigtail A (green and brown wires) from above onto this connection to complete the RH stop, turn, and tail circuits.

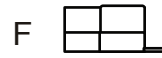

LIGHT GREEN

Back up lamp feed

Route this wire to the LH back up lamp area, cut to length, double this wire with the cut off portion, install terminal D and plug into connector L as shown on sheet 1. Route the loose end of this light green wire over to the RH back up lamp area, cut to length, install terminal C and plug into connector L as shown on sheet 1. Plug your factory assembled back up lamps onto connectors L from above as shown on sheet 1 to complete your two back up lamp connections. New terminals J and connectors Q have been provided in the event that the original ends from your back up lamps have been damaged.

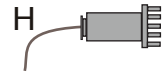

WHITE

Courtesy ground

At the driver's side kick panel area, cut this wire, double it with the cut off portion using terminal D and plug into connector E maintaining color continuity with the mating connector in the courtesy lamp kit (bag N). If you are using a dome lamp, loop the loose end of this wire so that it remains in the kick panel area, cut to length, install terminal J and plug into connector F in location shown on sheet 1.

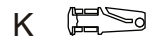
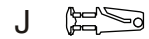

ORANGE

Courtesy Lamp Feed

Dome extension: Install the loose white wire/wires R (supplied with terminal installed) into the dome lamp housing/housings. Route the unterminated end/ends of this/these wire/wires to connector F as shown on sheet 1, trim to length, install terminal C (for single dome lamp applications) or terminal D (for dual dome lamp applications) and into plug connector E maintaining color continuity with the white wire in connector F.



At the driver's side kick panel area, cut this wire, double it with the cut off portion using terminal D and plug into connector E maintaining color continuity with the mating connector in the courtesy lamp kit (bag N). If you are using a dome lamp, loop the loose end of this wire so that it remains in the kick panel area, cut to length, install terminal K and plug into connector F in location shown on sheet 1. Route the loose end of this orange wire back to the trunk lid area, trim to length, install terminal C and connector L. Your factory trunk lamp lead will plug into this connection if so equipped.



Dome extension: Install the loose orange wire/wires R (supplied with terminal installed) into the dome lamp housing/housings. Route the unterminated end/ends of this/these wire/wires to connector F as shown on sheet 1, trim to length, install terminal C (for single dome lamp applications) or terminal D (for dual dome lamp applications) and into plug connector E maintaining color continuity with the orange wire in connector F.

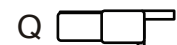

Your completed dome extension will plug into connector F in the LH kick panel area to complete your dome lamp connections.

Classic Update Series

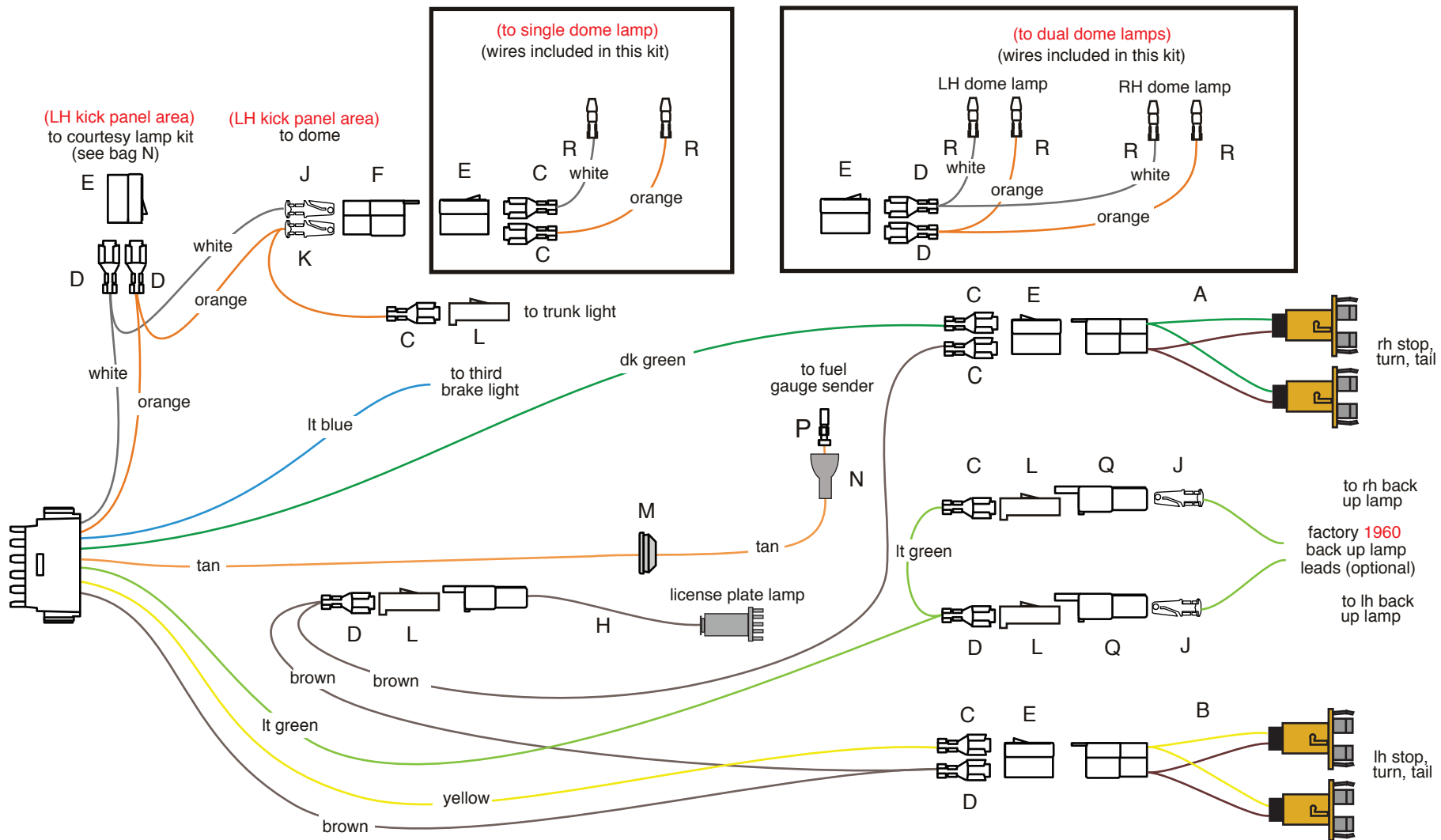

1960 Bel Air and Biscayne



American Autowire

www.americanautowire.com 856-933-0801

Classic Update Series **M**
 1959-60 Impala
 REAR BODY KIT
510222
 92969713 instruction rev 0.0 2/3/2011

1960 Bel Air and Biscayne (See sheet 3)

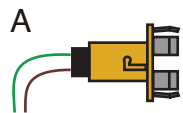

Connect the main connector to the mating connector on the dash harness 510219 bag G. Route this harness down the driver's door sill & into the trunk.
 LIGHT BLUE Third brake light
 TAN Fuel Tank Sender

Connect to the third brake lamp, if equipped.
 Route this wire to the rear of the car close to the exit hole in the trunk floor, slide the wire through grommet M and rubber sender connector N then down to the fuel tank sender, install terminal P (be sure you have a very tight crimp on this terminal) and pull the wire and terminal up inside of rubber connector N, then plug the assembled connector lead onto the sending unit to complete the fuel tank sender connection.

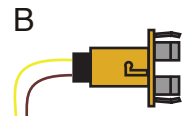

BROWN Running lamps

Note: A new license lamp lead H has been provided for you. Plug this onto connector L in the following rear body assembly instructions to complete your license lamp connection. New Stop/Tail lamp pigtails B and A (yellow and brown for LH driver's side, and green and brown for RH passenger's side) have been provided for you as well. Simply plug them onto connectors E in the following assembly instructions to complete your stop and tail lamp connections.



Route this wire to the LH tail lamp, cut to length, double this wire with the cut off portion, install terminal D and plug into connector E in the location shown on sheet 1. Route the loose end of this brown wire to the license lamp area, cut to length, double this wire with the cut off portion, install terminal D and plug into connector L as shown on sheet 1. Route the loose end of this brown wire to the RH tail lamp area, cut to length, install terminal C and plug into connector E in the location shown on sheet 1.



YELLOW LH Stop / Tail

Route this wire to the LH tail lamp area, cut to length, install terminal C and plug into the empty cavity of connector E as shown on sheet 1. Plug LH pigtail B (yellow and brown wires) from above onto this connection to complete the LH stop, turn, and tail circuits.

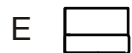

DK GREEN RH Stop / Tail

Route this wire to the RH tail lamp area, cut to length, install terminal C and plug into the empty cavity of connector E as shown on sheet 1. Plug RH pigtail A (green and brown wires) from above onto this connection to complete the RH stop, turn, and tail circuits.



LIGHT GREEN Back up lamp feed

Route this wire to the LH back up lamp area, cut to length, double this wire with the cut off portion, install terminal D and plug into connector L as shown on sheet 1. Route the loose end of this light green wire over to the RH back up lamp area, cut to length, install terminal C and plug into connector L as shown on sheet 1. Plug your factory assembled back up lamps onto connectors L from above as shown on sheet 1 to complete your two back up lamp connections. New terminals J and connectors Q have been provided in the event that the original ends from your back up lamps have been damaged.

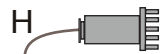

WHITE Courtesy ground

At the driver's side kick panel area, cut this wire, double it with the cut off portion using terminal D and plug into connector E maintaining color continuity with the mating connector in the courtesy lamp kit (bag N). If you are using a dome lamp, loop the loose end of this wire so that it remains in the kick panel area, cut to length, install terminal J and plug into connector F in location shown on sheet 1.



Dome extension: Install the loose white wire/wires R (supplied with terminal installed) into the dome lamp housing/housings. Route the unterminated end/ends of this/these wire/wires to connector F as shown on sheet 1, trim to length, install terminal C (for single dome lamp applications) or terminal D (for dual dome lamp applications) and into plug connector E maintaining color continuity with the white wire in connector F.



ORANGE Courtesy Lamp Feed

At the driver's side kick panel area, cut this wire, double it with the cut off portion using terminal D and plug into connector E maintaining color continuity with the mating connector in the courtesy lamp kit (bag N). If you are using a dome lamp, loop the loose end of this wire so that it remains in the kick panel area, cut to length, install terminal K and plug into connector F in location shown on sheet 1. Route the loose end of this orange wire back to the trunk lid area, trim to length, install terminal C and plug into connector L. Your factory trunk lamp lead will plug into this connection if so equipped.



Dome extension: Install the loose orange wire/wires R (supplied with terminal installed) into the dome lamp housing/housings. Route the unterminated end/ends of this/these wire/wires to connector F as shown on sheet 1, trim to length, install terminal C (for single dome lamp applications) or terminal D (for dual dome lamp applications) and into plug connector E maintaining color continuity with the orange wire in connector F.

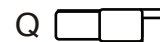

Your completed dome extension will plug into connector F in the LH kick panel area to complete your dome lamp connections.

Classic Update Series

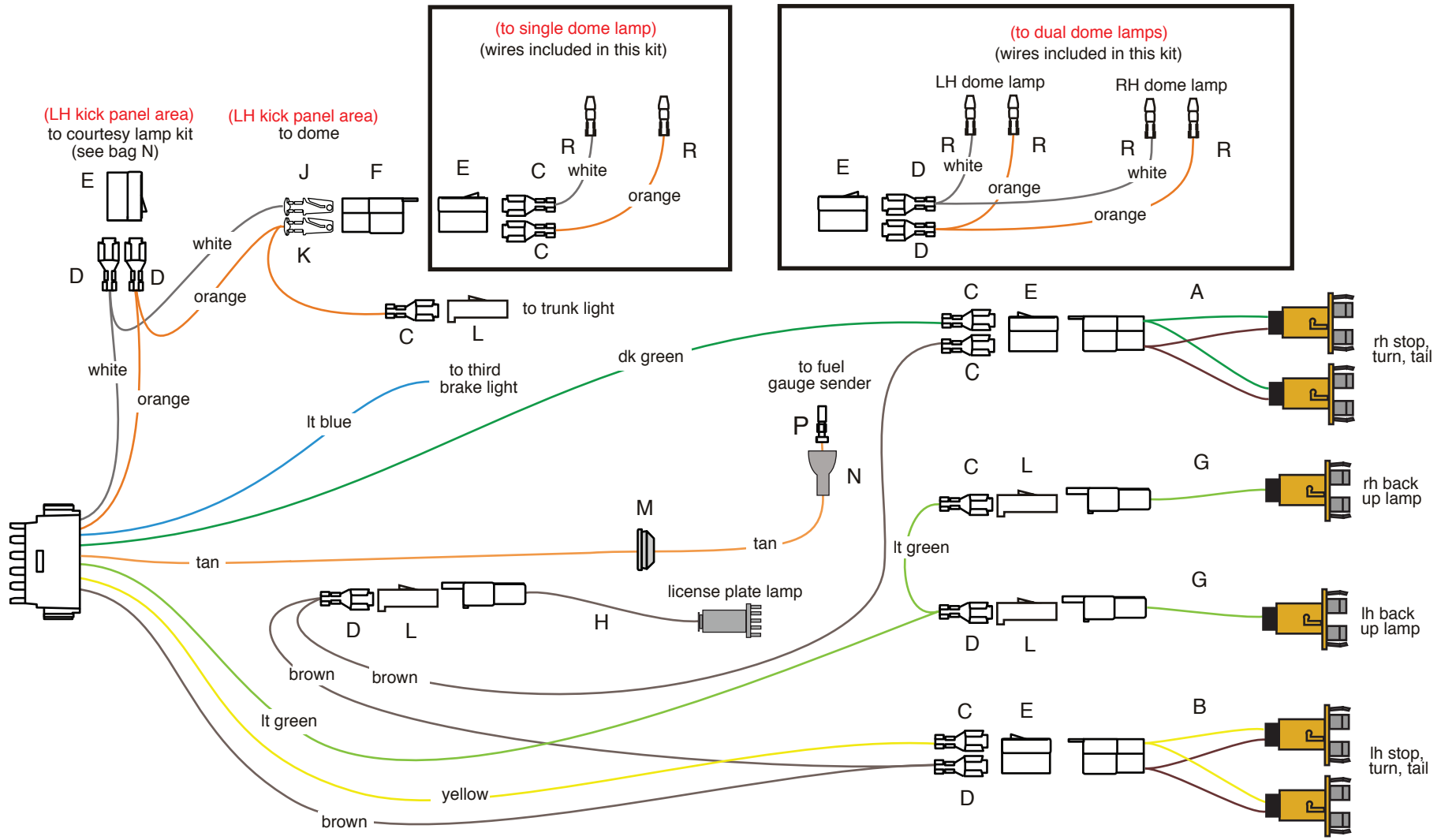

1960 IMPALA



www.americanautowire.com 856-933-0801

Classic Update Series bag
M

59-60 IMPALA

REAR BODY KIT

510222

92969713 instruction rev 0.0 2/3/2011

1960 Impala (See sheet 5)

Connect the main connector to the mating connector on the dash harness 510219 bag G. Route this harness down the driver's door sill & into the trunk.

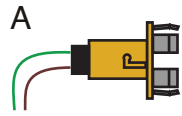

LIGHT BLUE
TAN

Third brake light
Fuel Tank Sender

Connect to the third brake lamp, if equipped.

Route this wire to the rear of the car close to the exit hole in the trunk floor, slide the wire through grommet M and rubber sender connector N then down to the fuel tank sender, install terminal P (be sure you have a very tight crimp on this terminal) and pull the wire and terminal up inside of rubber connector N, then plug the assembled connector lead onto the sending unit to complete the fuel tank sender connection.

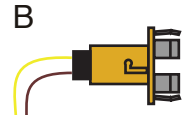

BROWN

Note: A new license lamp lead H has been provided for you. Plug this onto connector L in the following rear body assembly instructions to complete your license lamp connection. New Stop/Tail lamp pigtails B and A (yellow and brown for LH driver's side, and green and brown for RH passenger's side) have been provided for you as well. Simply plug them onto connectors E in the following assembly instructions to complete your stop and tail lamp connections.

Running lamps

Route this wire to the LH tail lamp, cut to length, double this wire with the cut off portion, install terminal D and plug into connector E in the location shown on sheet 1. Route the loose end of this brown wire to the license lamp area, cut to length, double this wire with the cut off portion, install terminal D and plug into connector L as shown on sheet 1. Route the loose end of this brown wire to the RH tail lamp area, cut to length, install terminal C and plug into connector E in the location shown on sheet 1.



YELLOW

LH Stop / Tail

Route this wire to the LH tail lamp area, cut to length, install terminal C and plug into the empty cavity of connector E as shown on sheet 1. Plug LH pigtail B (yellow and brown wires) from above onto this connection to complete the LH stop, turn, and tail circuits.



DK GREEN

RH Stop / Tail

Route this wire to the RH tail lamp area, cut to length, install terminal C and plug into the empty cavity of connector E as shown on sheet 1. Plug RH pigtail A (green and brown wires) from above onto this connection to complete the RH stop, turn, and tail circuits.



LIGHT GREEN

Note: Two new Back Up lamp pigtails G have been provided for you. Plug these onto connectors L in the following rear body assembly instructions to complete your two back up lamp connections.

Route this wire to the LH back up lamp area, cut to length, double this wire with the cut off portion, install terminal D and plug into connector L as shown on sheet 1. Route the loose end of this light green wire over to the RH back up lamp area, cut to length, install terminal C and plug into connector L as shown on sheet 1. Plug the new back up lamp pigtails from above onto these 2 connections to complete your back up lamp circuits.



WHITE

Courtesy ground

At the driver's side kick panel area, cut this wire, double it with the cut off portion using terminal D and plug into connector E maintaining color continuity with the mating connector in the courtesy lamp kit (bag N). If you are using a dome lamp, loop the loose end of this wire so that it remains in the kick panel area, cut to length, install terminal J and plug into connector F in location shown on sheet 1.

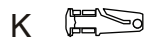
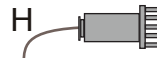

ORANGE

Courtesy Lamp Feed

Dome extension: Install the loose white wire/wires R (supplied with terminal installed) into the dome lamp housing/housings. Route the unterminated end/ends of this/these wire/wires to connector F as shown on sheet 1, trim to length, install terminal C (for single dome lamp applications) or terminal D (for dual dome lamp applications) and into plug connector E maintaining color continuity with the white wire in connector F.



At the driver's side kick panel area, cut this wire, double it with the cut off portion using terminal D and plug into connector E maintaining color continuity with the mating connector in the courtesy lamp kit (bag N). If you are using a dome lamp, loop the loose end of this wire so that it remains in the kick panel area, cut to length, install terminal K and plug into connector F in location shown on sheet 1. Route the loose end of this orange wire back to the trunk lid area, trim to length, install terminal C and plug into connector L. Your factory trunk lamp lead will plug into this connection if so equipped.

Dome extension: Install the loose orange wire/wires R (supplied with terminal installed) into the dome lamp housing/housings. Route the unterminated end/ends of this/these wire/wires to connector F as shown on sheet 1, trim to length, install terminal C (for single dome lamp applications) or terminal D (for dual dome lamp applications) and into plug connector E maintaining color continuity with the orange wire in connector F.

Your completed dome extension will plug into connector F in the LH kick panel area to complete your dome lamp connections.

A  (1)
 (144.0" 6 Gauge charge wire)

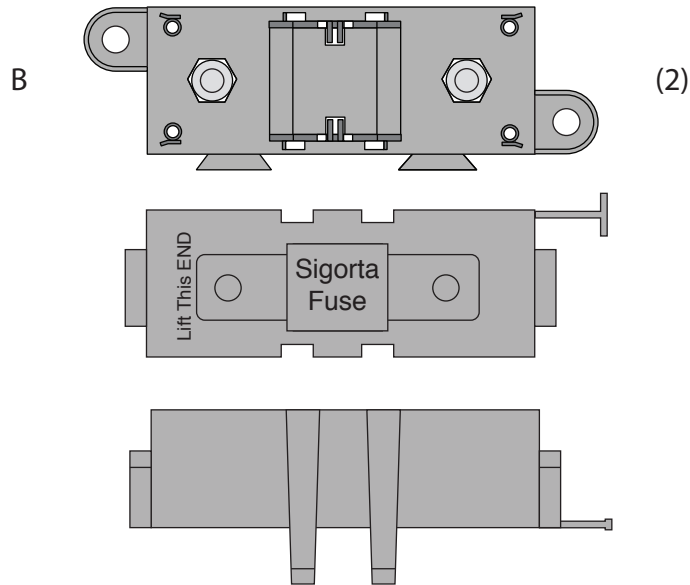

1. On this page, you will find the wire, fuse bodies, fuses, boot, ring terminals, and shrink tubing (items A through K) that are necessary to connect your alternator and main power feed for your new AAW wiring kit. Please be sure that all of the necessary components are present before starting this portion of your installation. If anything is missing, stop what you are doing and contact AAW at the number listed below right away.

2. On page 2, you will find directions for building the 2 Megafuse assemblies (items B,C and D) into one unit.

3. On page 3, you will find an overall concept of how to connect the Megafuse assemblies to your starter solenoid, alternator and main power feed of your new wiring system.

4. On page 4, you will find tips on building your charging circuit wires and assembling them and the main panel power feed wire to the Megafuse assemblies.

(Megafuse body, cover and two M8 x 1.25 nuts / lock washers)

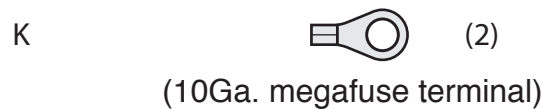
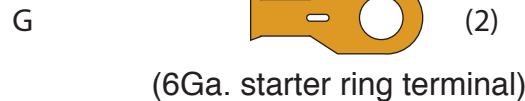
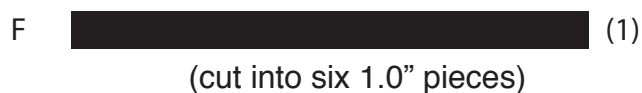
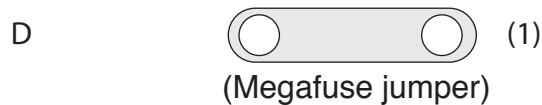
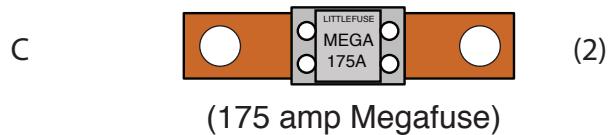

www.americanautowire.com 856-933-0801

PART #

510476

Z

DESCRIPTION:

Alternator and Main Power
 Connection Kit
 Various Applications

92972153 instruction sheet rev 0.1 6/24/2019

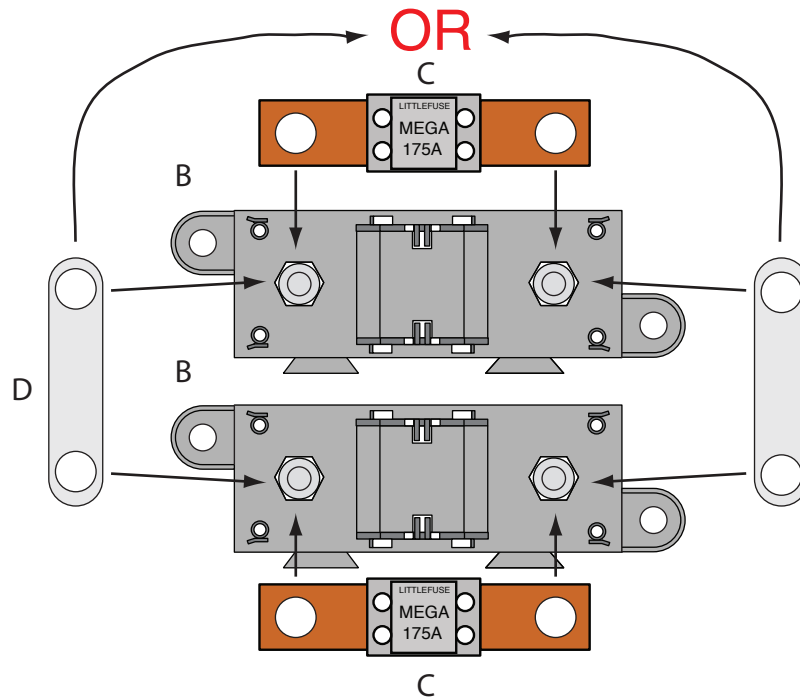

Assembling the (2) Megafuse assemblies

NOTE: Find a suitable place, as close to the battery power source as possible, under the hood of your vehicle to mount the completed Megafuse assemblies. Keep in mind that you have 12 feet of 6Ga. charging wire, and that the main power feed coming from your panel or bulkhead connection must also be able to reach the assembly.

1. Take the two Megafuse bodies and covers (items B) and snap them together. Remove the 4 nuts and lock washers from the studs on the fuse body assemblies.
2. Install the Megafuse jumper (item D above) over two of the studs on the Megafuse bodies. It is very important that the jumper **MUST BE** assembled on the side that is going to connect to your main power connection (starter solenoid or battery feed).
3. Notch top cover to clear jumper D as shown at right.
4. Snap one 175amp fuse (items C) onto the studs of each of the two Megafuse bodies (items B), over the jumper, then loosely re-attach the 4 nuts and lock washers back onto the assembled Megafuses. The fuse assemblies are ready to install into your vehicle.

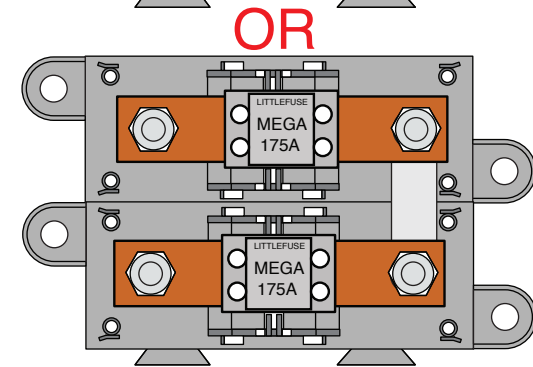
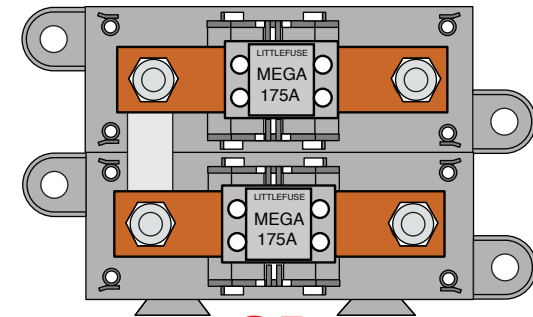

Assembled Megafuses

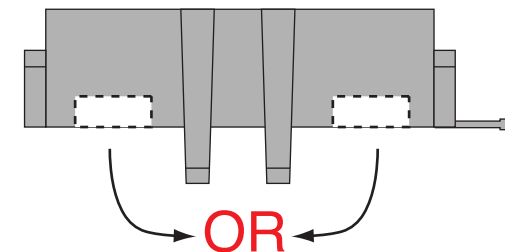

Notched Cover

PART #

510476

Z

DESCRIPTION:

Alternator and Main Power
Connection Kit
Various Applications

92972153 instruction sheet rev 0.1 6/24/2019

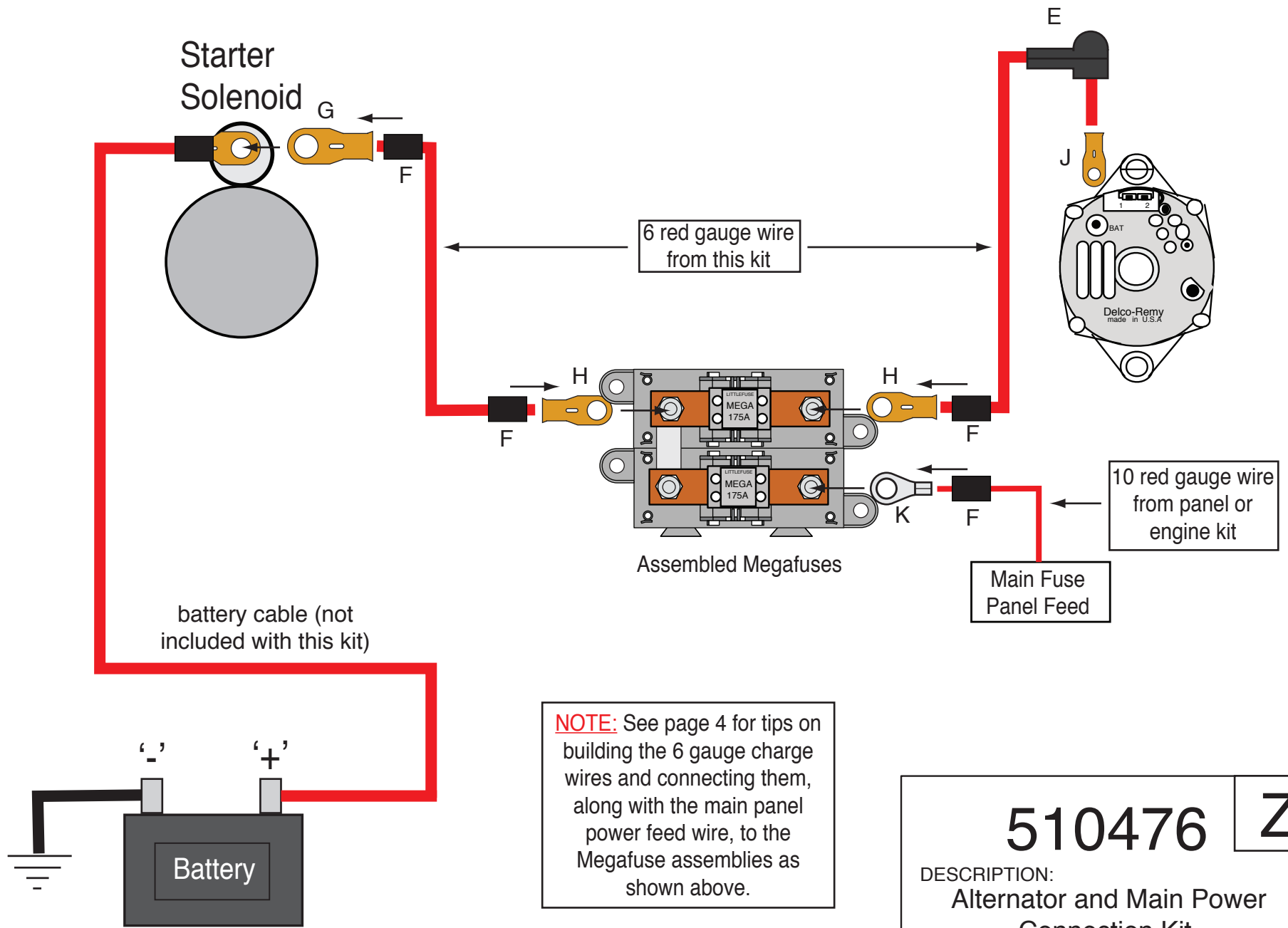

NOTE: See page 4 for tips on building the 6 gauge charge wires and connecting them, along with the main panel power feed wire, to the Megafuse assemblies as shown above.

<h1 style="margin: 0;">510476</h1>	Z
<p>DESCRIPTION: Alternator and Main Power Connection Kit Various Applications</p>	
<p>92972153 instruction sheet rev 0.1 6/24/2019</p>	

Building the 6Ga. charge wires and connecting them and the main panel power feed wire to the Megafuse assemblies:

NOTE: Make sure that your battery is disconnected! You will need to install the preassembled Megafuses from page 2 in your vehicle to start this part of the installation.

1. Pre-cut item F shrink tubing into (6) 1.00" - 1.25" pieces.
2. Take the 12-foot piece of 6Ga. red wire from this kit and route it from your starter (or other battery feed) over to the area where you have mounted your Megafuse and cut it to length. Strip the insulation on each end back 1/2". Install 2 pieces of shrink tubing F onto the wire. At the starter end, crimp and solder (1) of terminal G onto the wire. At the Megafuse end, crimp and solder (1) of terminal H onto the wire. Slide the shrink tubing over the terminals and heat it up to shrink it down.
3. Take the remaining portion of the 12-foot piece of 6Ga. red wire from this kit and route it from your alternator over to the area where you have mounted your Megafuse and cut it to length. Strip the insulation on each end back 1/2". Install 1 piece of shrink tubing F onto the wire. At the alternator end, slip on boot E as shown on page 3, then crimp and solder (1) of terminal J onto the wire. At the Megafuse end, crimp and solder (1) of terminal H onto the wire. Slide the shrink tubing over terminal H and heat it up to shrink it down.
4. Take the 10Ga. red main power feed wire from your engine or panel sub-kit and route it over to the area where you have mounted your Megafuse and cut it to length. Strip the insulation back 3/8". Install 1 piece of shrink tubing F onto the wire, then crimp and solder (1) of terminal K onto the wire.
5. Remove the 4 loosely tightened nuts and lock washers from the assembled Megafuses, then using the drawing on page 3 as a guide, install your pre-assembled wires from steps 2-4 above. Re-install the 4 nuts and lock washers onto the assembled Megafuses and tighten them down. This part of your installation is now complete.

510476

Z

DESCRIPTION:

**Alternator and Main Power
Connection Kit
Various Applications**

92972153 instruction sheet rev 0.1 6/24/2019

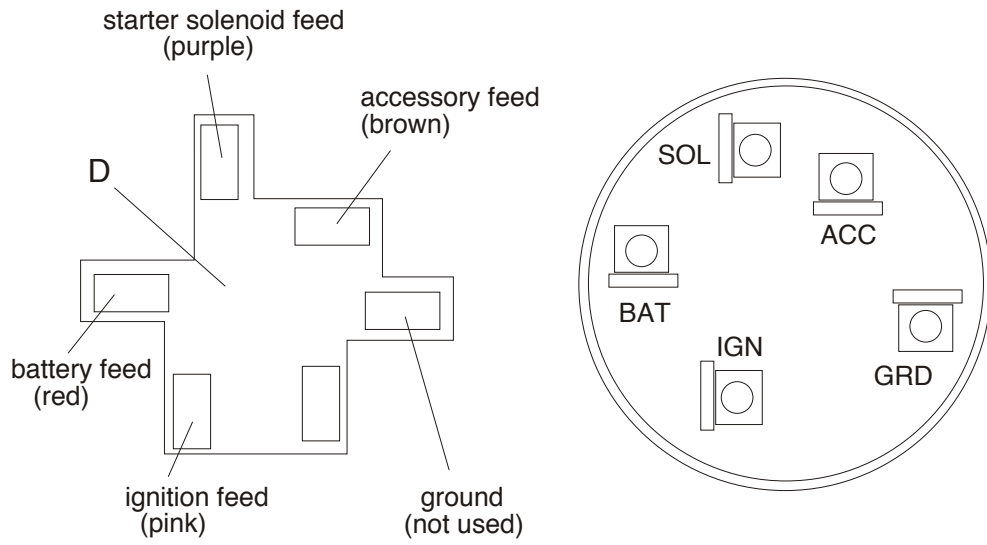

NOTE: View from back of connector.

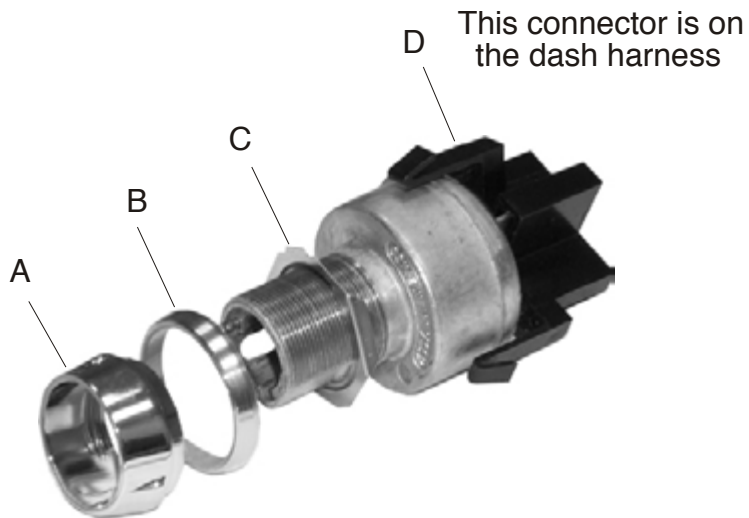

NOTE: Please keep in mind that this is an upgraded switch, not an original replacement, and as such, the flat side on this switch may be in a different location than was your original. If you mount this new AAW switch in your dash and the flat side is in fact in a different location, the key may not line up as the original did. This will not alter the performance of the switch in any way. If you wish for your key to line up as it did in the OEM application, you will need to file out the flat spot in your original dash opening so that the switch can be rotated to the correct position. Once the backing nut C is set so that the depth of the switch is correct for your application, and bezel nut A is firmly tightened, the switch will be secure and will not rotate.

INSTALLATION:

NOTE: The instruction sheet packaged with this switch shows a copper lamp holder bracket. That bracket is not used in this application and it's installation can be ignored.

1. Due to the nature of the chrome plating on threaded collar A, AAW recommends threading the nut on and off of the switch by hand a few times to clean up the threads before installing the switch into your dash.
2. Plug in connector D from the dash wiring harness (bag G).
3. Install the back-up nut C onto the switch. The depth of this nut will have to be determined when mounting the switch.
4. Insert the switch into the hole in the dash panel.
5. Install your original dash bezel plate.
6. Slide on collar B.
7. Screw on threaded collar A
8. Insert your original or New AAW lock cylinder into the new switch to complete your installation.

NOTE: AAW has new lock cylinders with the correct GM style keys for your new 500684 ignition switch. Check below for your vehicle's correct application.



AAW P/N 500672 (with finger guard):

- 500423 - 1955-56 Chevy car
- 500434 - 1957 Chevy car
- 500481 - 1955-59 Chevy Truck
- 510217 - 1959-60 Chevy Impala
- 510063 - 1961-64 Chevy Impala
- 510267 - 1953-62 Chevy Corvette



AAW P/N 500674 (smooth face):

- 500467 - 1947-55 Chevy Truck
- 500560 - 1960-66 Chevy truck
- 510360 - 1965 Chevy Impala
- 510372 - 1966-68 Chevy Impala



**American
Autowire**

www.americanautowire.com 856-933-0801

IGNITION SWITCH
Classic Update Series
VARIOUS APPLICATIONS

500684

92965941 instruction rev 6.0 8/1/2018

Most switches supplied with Classic Update and Universal Kits ship with the shaft pre-installed. In many instances, the switch can be installed without removing the shaft, but in some cases the switch shaft may need to be trimmed to fit your specific dash. In this situation, reference Trim to Fit instructions on the back of this page for details.

To install your new headlight switch:

1. Install the switch from behind the dash, and align the switch body with the mounting hole. The switch body has an alignment tab that must line up with the notch in the dashboard mounting hole.

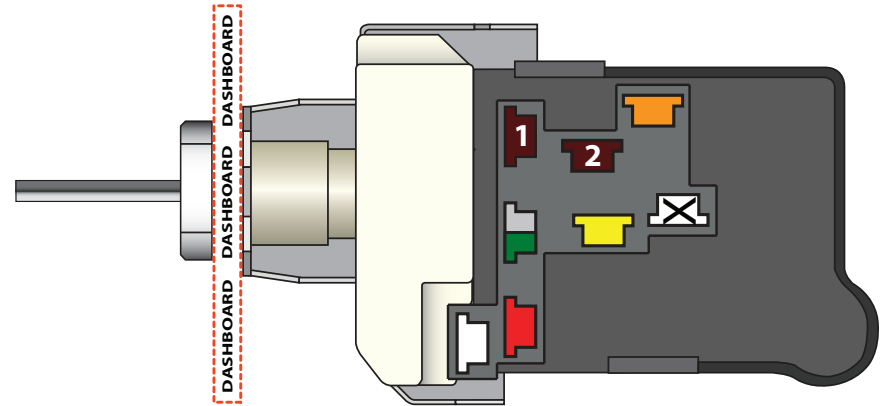
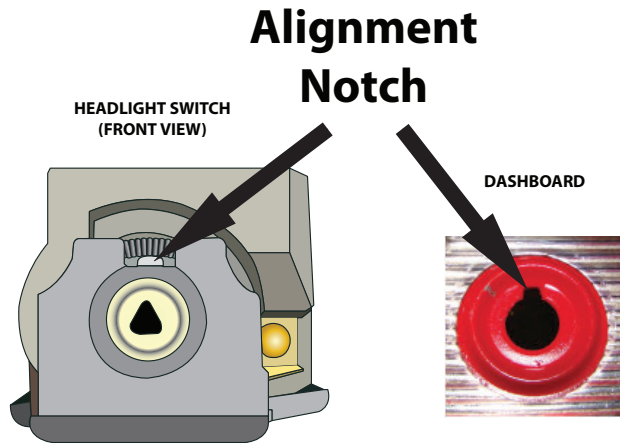

1	Parking Lights - Stay on with headlights
2	Tail Lights - On in the park and headlight positions
	Fused Battery Feed - For park, tail and dash lamps
	Headlight Feed - Power to the headlight dimmer switch
	12V Battery Feed - Unfused power to the switch for headlights
	Courtesy Ground - Ground feed to the dome and courtesy lights
	Part-time Parking Lights - Turns off when the headlights are on (Not supported by all kits)
	Dash Lights - Output to the dash light fuse or lights

2. Install the switch mounting nut and tighten.
3. Gently press shaft into switch until it stops, then press firmly until it "clicks." Pull shaft back out to confirm it is seated correctly. The shaft should be locked into place inside switch.
4. If the shaft does not lock, reinsert applying moderate pressure and slowly move shaft side to side for lock to engage. Make sure switch body is still supported to prevent flexing. Press shaft firmly until it clicks into place.
5. Ensure the shaft is fully seated and in the off position.



www.americanautowire.com 856-933-0801

PART # **500332**
 DESCRIPTION:
Headlight Switch

92964649 Rev 3.0 1/10/2020

To Trim Shaft to Fit or Remove Shaft:

The headlight shaft knob should extend from the face of the mounting nut, and must allow enough clearance for the switch to turn off. If the shaft is longer than necessary for your specific dash it can be trimmed to fit. Always trim the knob end of the shaft only and follow the guidelines below for best results.

1. With the headlight switch installed, loosen the set screw and remove the knob. Make sure the switch is in the "off" position by pushing the shaft toward the back of the switch.

Switch in OFF position
(shaft pushed all the way in)

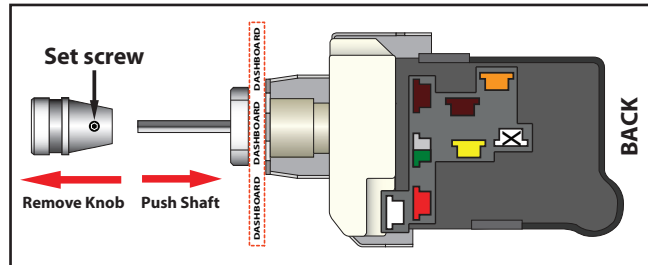

2. Set knob alongside shaft and mark the desired location for cutting on the shaft.

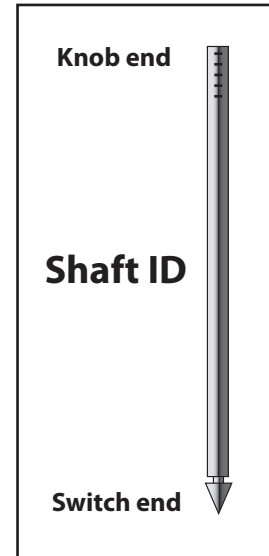
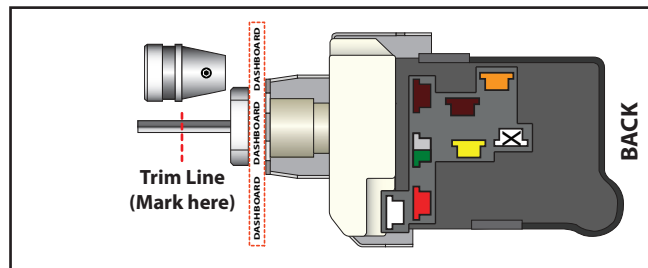

3. Remove the shaft and trim at mark. The shaft can be released from the switch by pulling it outward (toward the rear of the vehicle). Once fully in the "On" position, press and hold the release button on the base of the switch body. Once button is pressed, continue to pull the shaft outward. New switches may be tight, and it might be necessary to move the shaft side to side slightly while pulling to release.

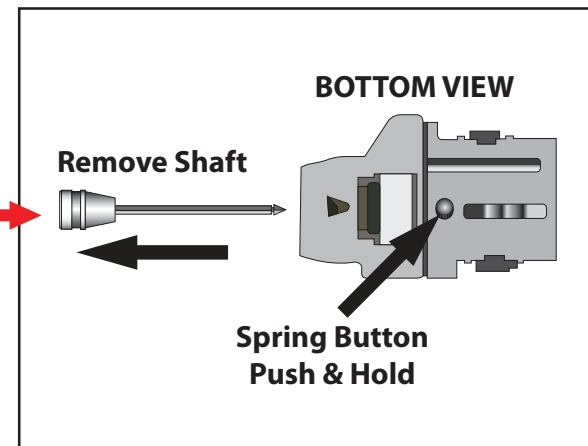
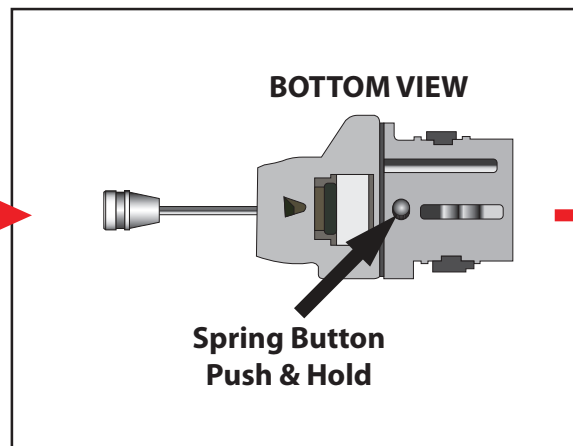
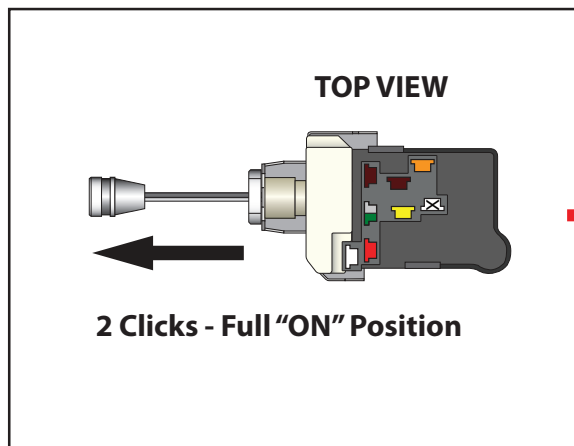

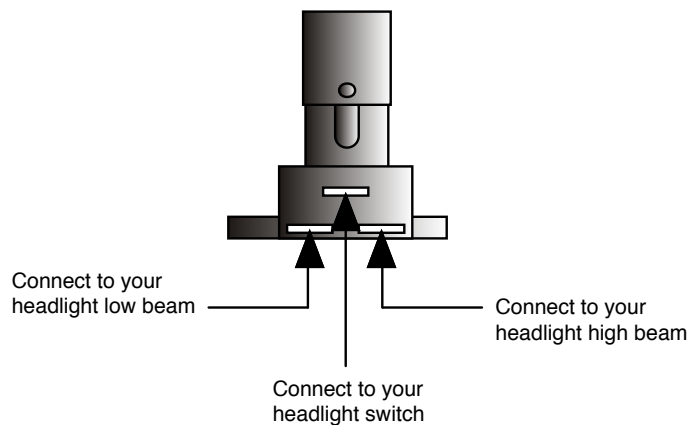

Connect the Dimmer Switch wires as shown above.

1. The top center terminal of the Dimmer Switch is connected to the Headlight switch.
2. The terminal on the right side is connected to your headlight high beam terminal.
3. The terminal on the left side is connected to your headlight low beam terminal.



www.americanautowire.com 856-933-0801

PART #

500042

DESCRIPTION:

DIMMER SWITCH

92964573 Rev 3.1 12/5/2014

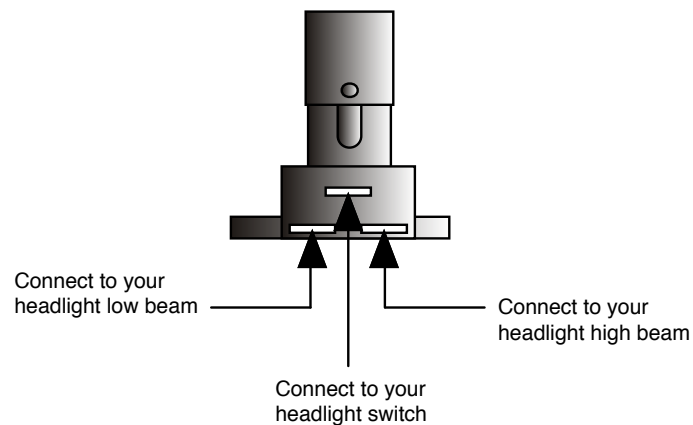

Connect the Dimmer Switch wires as shown above.

1. The top center terminal of the Dimmer Switch is connected to the Headlight switch.
2. The terminal on the right side is connected to your headlight high beam terminal.
3. The terminal on the left side is connected to your headlight low beam terminal.



www.americanautowire.com 856-933-0801

PART #

500042

DESCRIPTION:

DIMMER SWITCH

92964573 Rev 3.1 12/5/2014