

PAINLESS[®]

PERFORMANCE PRODUCTS

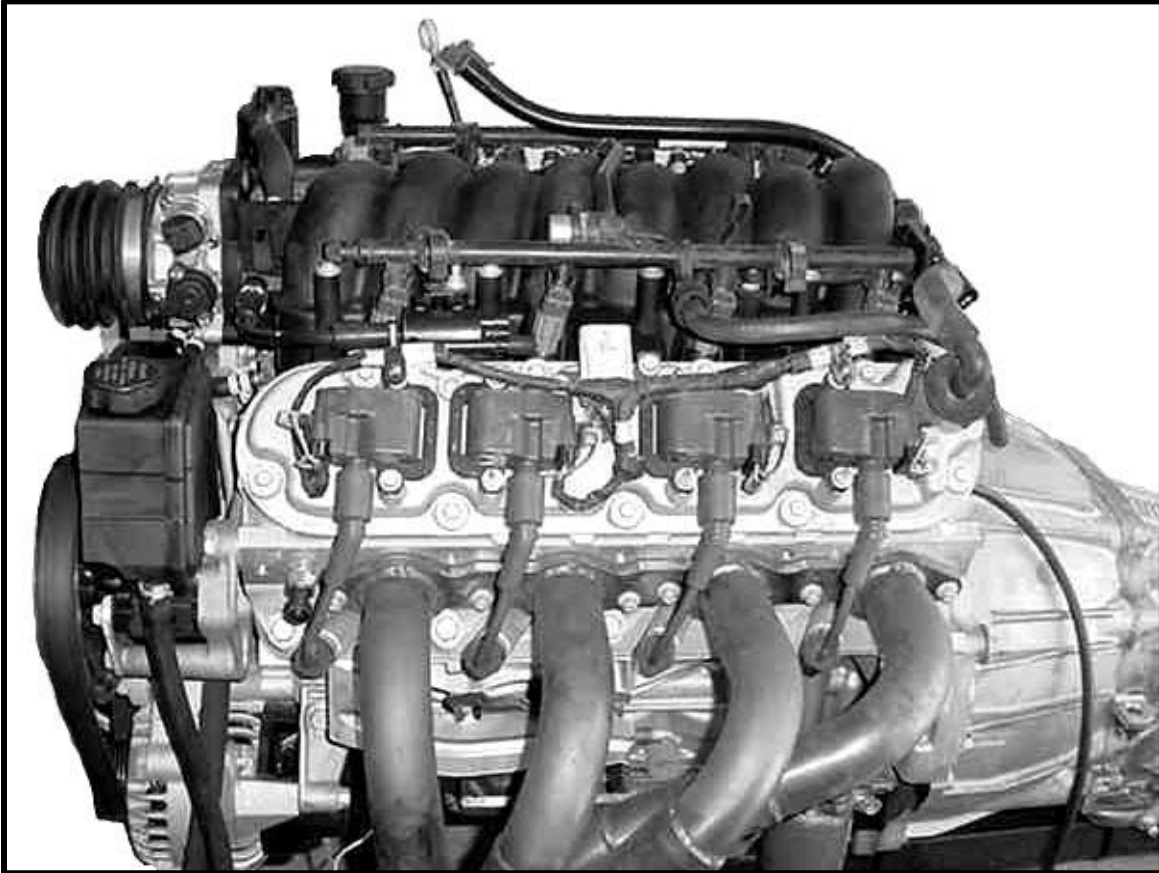

Wire Harness Installation Instructions

For Installing Harness Numbers:

60508: 98 – 04 GM LS1/LS6 EFI Harness

60509: 98 – 04 GM LS1/LS6 EFI Extra Length Harness

**60713 & 60715: 98 – 04 GM LS1/LS6 EFI Harness & VATS
Removed ECM**

Manual P/N 90520

Painless Performance Products recommends you, the installer, read this installation manual from front to back before installing this harness.

Painless Performance Products, LLC
2501 Ludelle St.
Fort Worth, TX 76105-1036
PHONE: 800-423-9696 FAX: 817-244-4024
EMAIL: support@painlessperformance.com

If you have any questions concerning the installation of this harness, feel free to call Painless Performance Products' Tech Line at 1-800-423-9696. The Tech Line can be reached from 8 A.M. to 5 P.M. central time, Monday through Thursday, and 8 A.M. to 4:30 P.M. on Fridays.

We have attempted to provide you with as accurate of instructions as possible and are always concerned about corrections or improvements that can be made. If you have found any issues or omissions, or simply have comments or suggestions concerning these instructions, please write us at the above address, send us a fax at (817) 244-4024, or email us at support@painlessperformance.com. We sincerely appreciate your business.

Painless Performance Products, LLC shall in no event be liable in contract or tort (including negligence) for special, indirect, incidental, or consequential damages, such as but not limited to, loss of property damage, or any other damages, costs or expenses which might be claimed as the result of the use or failure of the goods sold hereby, except only the cost of repair or replacement.

12th Edition: November 2019
Copyright © 2019 by Painless Performance Products, LLC

CAUTION: BEFORE THE REMOVAL OF YOUR ORIGINAL HARNESS AND/OR THE INSTALL OF YOUR NEW PAINLESS HARNESS, DISCONNECT THE POWER FROM YOUR VEHICLE BY REMOVING THE NEGATIVE OR POSITIVE BATTERY CABLE FROM THE BATTERY.

TABLE OF CONTENTS

<u>PAGE #</u>	<u>SECTION</u>
5	1. <u>INTRODUCTION</u>
6	2. <u>ABOUT THESE INSTRUCTIONS</u>
6	3. <u>TOOLS NEEDED</u>
7	4. <u>PRE-INSTALLATION AND HARNESS ROUTING GUIDELINES</u>
7	4.1 TRANSMISSION FUNCTION
8	4.2 GET TO KNOW THE ENGINE YOU ARE USING
9	4.3 A/C COMPRESSOR CLUTCH SIGNAL
9	5. <u>GENERAL INSTALLATION INSTRUCTIONS</u>
10	5.1 GROUNDING THE VEHICLE
10	5.2 ROUGH INSTALLATION
10	5.3 HARNESS ATTACHMENT
11	5.4 TERMINAL INSTALLATION INSTRUCTIONS
12	6. <u>INSTALLATION</u>
12	6.1 KIT CONTENTS
12	6.2 SPECIFIC CIRCUIT CONNECTIONS
16	6.3 ENGINE GROUP INSTALLATION
20	6.4 TAIL SECTION INSTALLATION
22	6.5 MODIFICATIONS FOR USE OF A 4L80E TRANSMISSION
24	7. <u>TROUBLE-SHOOTING INSTRUCTIONS</u>
24	7.1 THE "CHECK ENGINE" LIGHT
24	7.2 RETRIEVING TROUBLE CODES FROM THE COMPUTER
25	7.3 TROUBLE SHOOTING GUIDE FOR YOUR PAINLESS PERFORMANCE HARNESS
27	7.4 WHEN TO CALL PAINLESS WIRING TECH LINE
27	<u>LIMITED WARRANTY AND RETURN POLICY</u>

LIST OF FIGURES

<u>PAGE #</u>	<u>SECTION</u>	<u>FIG. #</u>
12	DLC CONNECTOR & CHECK ENG LIGHT	6.1
13	BRAKE SWITCH CONNCTIONS	6.2
14	BRAKE SWITCH RELAY	6.3
14	GEAR INDICATOR SWITCH	6.4
15	FUEL PUMP RELAY CONNECTOR	6.5
17	KNOCK SENSOR	6.6
17	MAP SENSOR	6.7
18	CAM PROSITION SENSOR	6.8
18	CRANK POSITION SENSOR	6.9
18	PASS. SIDE COIL CONNECTOR	6.10
18	INJECTORS 2, 4, 6, & 8	6.11
18	TPS SENSOR	6.12
18	IAC	6.13
19	INJECTORS 1, 3, 5, & 7	6.14
19	DRIVER SIDE COIL CONNECTOR	6.15

Continued...

LIST OF FIGURES

<u>PAGE #</u>	<u>SECTION</u>	<u>FIG. #</u>
19	ECT SENSOR	6.16
19	MAF SENSOR	6.17
19	IAT SENSOR	6.18
19	O2 SENSOR	6.19
21	VSS	6.20
21	TRANSMISSION CONNECTION (4L60E)	6.21
21	TRANSMISSION CONNECTION (T56)	6.22
21	VSS & INPUT SPEED SENSORS, TRANSMISSION CONNECTION (4L80E)	6.23
22	TRANSMISSION CONNECTOR PIN OUT	6.24
23	ECM TERMINAL LOCK	6.25
23	INPUT SPEED SENSOR CONNECTION TO ECM	6.26
24	FUSE IDENTIFICATION	7.1
26	NOID LIGHT	7.2

LIST OF TABLES

<u>PAGE #</u>	<u>SECTION</u>	<u>TABLE #</u>
8	COMPATIBLE PARTS	4.1
15	DASH SECTION CONNECTIONS	6.1
17	ENGINE SECTION CONNECTIONS	6.2
20	TAIL SECTION CONNECTIONS	6.3

1. INTRODUCTION

We at Painless Performance Products believe you have purchased the most up-to-date and easiest to install automotive fuel injection harness on the market. All components to this harness are new. All harnesses are tested for faults before they leave the factory floor. This harness is designed for easy installation, even if you have no electrical experience.

The 60508/60509 harnesses are designed to be a complete wiring system for the fuel injection system on a 1997-02 LS1 with a mechanical (cable) throttle body and T56 manual, 4L60E or 4l80e automatic transmissions. Non electronic controlled transmissions such as a Turbo 400/350 or 700r4 may also be used, but additional wiring may be required and must be supplied by the installer. This harness may also be used on 1999-2006 Vortec 4.8, 5.3, 6.0 engines that have had an LS1 intake manifold and mechanical throttle body installed.

Factory computers from 1999-02 Camaros or Firebirds, equipped with the LS1, may be used with this harness. These computers were service #9354896 or #12200411; the 60508/60509 will only work with one of these ECM part numbers that has been flashed with a V8 operating system. Some 12200411 ECMs were used in other applications. If you are unsure of an ECM's origin, such as purchasing one second hand through the internet or a wrecking yard, contact Painless and purchase an ECM guaranteed to work). An ECM with the wrong operating system will be useless.

These harnesses include all wiring that is needed by the computer to run and control the fuel injection system and transmission. This harness will get the LS1 engine and transmission up and operating. It is recommended that you have the computer reprogrammed to remove anything in the original factory programming that relates to a device or devices that are not being used in your particular vehicle.

NOTE: Most likely the check engine light will come on and stay on when using a computer with the original factory programming. This is normal and is why we recommend that the computer be reprogrammed.

NOTE: This computer must be reprogrammed to remove the Vehicle Anti-Theft System (VATS) This service is available thru Painless Performance. Contact us at 800-423-9696, or on the web at www.Painlessperformance.com for more details

NOTE: Most remanufactured computers come without any programming in them and must be programmed before they can be used.

NOTE: The program in your computer must match the transmission that you plan on using. You cannot run a 4L60E transmission with a computer programmed for a T56.

Usually, the computer relays and fuse block can easily be mounted under the dash. Most of the wiring in the harness has been pre-terminated to the proper connector and all wire has been GM color-coded. All wiring is TXL, 600 volt, and 125 degree centigrade with cross-link insulation.

These fuel injection system harnesses have been divided into the following three major groups:

ENGINE GROUP Includes wiring for the fuel injectors, alternator, ignition system, and sensors.

DASH GROUP

Includes ignition feed wire, assembly line diagnostic link (DLC) connector, check engine light, computer connectors, brake switch wiring, gear shift indicator wiring, tachometer signal, fan relay control, fuse block, fuel pump relay connector (These emission sections are not included in the 60508-9 harnesses) air pump, air bleed, canister purge, canister vent, air pump and air solenoid relays.

TAIL GROUP

Includes VSS wiring, transmission wiring and a power wire for the fuel pump. **Those using a 4L80E transmission, see page 22 of these instructions for modifications needing to be made before this harness is installed.**

2. ABOUT THESE INSTRUCTIONS

These instructions provide information for the installation of the 60508 & 60509 LS1 fuel injection harness kits. The contents of these instructions are divided into the following major sections:

- 1.0 INTRODUCTION**
- 2.0 ABOUT THESE INSTRUCTIONS**
- 3.0 TOOLS NEEDED**
- 4.0 PRE-INSTALLATION AND HARNESS ROUTING GUIDELINES**
- 5.0 GENERAL INSTALLATION INSTRUCTIONS**
- 6.0 GM LS1 FUEL INJECTION HARNESS KIT**
- 7.0 TROUBLE-SHOOTING INSTRUCTIONS AND TROUBLE CODES**

Sections are further divided into **Paragraphs** and **Steps**. Throughout, the **Figure** numbers refer to illustrations and the **Table** numbers refer to information in tables. These are located in or near the sections or paragraphs to which they correspond. Always pay careful attention to any notes or any text labeled **CAUTION**.

3. TOOLS NEEDED

In addition to your regular tools, you will need, at least, the following:

- | | |
|-------------------|--|
| Crimping tool | NOTE: USE A QUALITY TOOL TO AVOID OVER-CRIMPING. |
| Wire stripper | |
| Continuity tester | CAUTION: DO NOT USE A TEST LIGHT TO TEST THE COMPUTER OR SENSOR WIRING. YOU WILL DAMAGE THE COMPUTER. |
| Electric drill | |
| 1 5/8" Hole saw | NOTE: FOR THE RUBBER GROMMET IN THE FIREWALL |

4. PRE-INSTALLATION AND HARNESS

ROUTING GUIDELINES

The installation of your harness kit will consist of two parts:

- The physical routing, positioning, and securing of the harness, wire groups, and individual wires and connectors.
- The proper electrical connection of the individual circuits.

We cannot tell you how to route the harness in your vehicle. That depends a great deal upon the particular make of the vehicle and what extent you want to secure and conceal the harness. We do offer some general guidelines and routing practices starting in **Paragraph 5.3**, general installation instructions in **Section 5.0**, and precise instruction concerning the electrical connections you will have to make beginning in **Section 6.0**. To help you begin thinking through the installation of your wire harness, read the following sections:

4.1 TRANSMISSION FUNCTION

If you are using the T56 transmission, read **Paragraph 4.1.1**, then skip to the note on the next page. If you are using the 4L60E, then skip **Paragraph 4.1.1**, and start at **paragraph 4.1.2**.

- 4.1.1** If you are using a **T56 transmission**, tape off and store the **PURPLE** and **PINK** (brake switch) wires, the **ORANGE/BLACK** and **BLACK/WHITE** (gear indicator switch) wires in the dash group and the 13-position (transmission) round connector in the tail section. Plug in the skip shift solenoid, reverse lockout solenoid and vehicle speed sensor connector to the transmission as shown in **Figure 6.28**. We have included a wire to turn on a skip shift light if you are planning on using one. This wire is **WHITE/BLACK** and provides a ground to the skip shift light. You must connect power to the other side of the light.
- 4.1.2** If you **ARE** going to use a **4L60E transmission**, tape off and store the skip shift light wire, skip shift solenoid and reverse lockout solenoid connectors. You must use the vehicle speed sensor (VSS), correct brake switch and a gear indicator switch. These are necessary to make the transmission work correctly. The brake switch should be closed (electrically connected) when the brakes **ARE NOT** being applied and open (not electrically connected) when the brakes **ARE** being applied. This is the opposite of a standard brake light switch. If you are using a pressure brake switch, a **SPDT** relay must be installed to unlock the converter when the brakes are applied.

4.2 GET TO KNOW THE ENGINE YOU ARE USING:

NOTE: The 97-02 LS1 engine had four oxygen sensors from the factory. We have included provisions for only two oxygen sensors, which include one on the driver side and one on the passenger side of the engine. We have removed the two rear oxygen sensors since they originally were behind the catalytic converters and most people don't want to run more than two oxygen sensors.

4.2.1 Painless Performance recommends the use of the following parts. The numbers given are GM and AC Delco part numbers.

Main Computer	Service #9354896 Service #12200411 Painless #60700	TPS Sensor	GM #17123852 Delco #213-912
Fuel Pump Relay	Painless #80130	MAP Sensor	GM #16212460 Delco #213-331
Brake Switch	Delco #D850A	Idle Air Control Motor	GM #17113391
Gear Indicator Switch	Delco #D2286A	Knock Sensors	GM #10456603 Delco# 213-362
Intake Air Temperature	GM #12160244 Delco #213-243	Coils	GM #12558948 Delco# D580
MAF Sensor	Delco #2133457	Cam Position Sensor	GM #12561211 Delco# 213-363
Engine Coolant Temperature	GM #15326388 Delco #213-953	Crankshaft Position Sensor	GM #12560228 Delco# 213-354
Oxygen Sensor (Pass. Side)	GM #25312196 Delco #AFS123	VSS(4L60E Only)	Delco# 213-328
Oxygen Sensor (Driver Side)	GM #25312197 Delco #AFS98		

Table 4.1 Compatible Parts

- 4.2.2** Familiarize yourself with the harness by locating each of the harness groups and by looking at the connectors on the wire ends.
- 4.2.3** Decide where and how the computer, fuse block and relays will be mounted. Painless wire harness kits are designed to mount either under the dash or in the kick panel on the passenger side. They must be no further apart than the wiring will allow (approx. 18 inches).
- 4.2.4** A good exercise is to lay out the wire harness on the floor beside your vehicle and identify all the connectors and wires.
- 4.2.5** You will want to route the harness through and around open areas. Inside edges provide extra protection from hazards and also provide places for tie wraps, clips and other support. Route the harness away from sharp edges, exhaust pipes, and the hood, trunk and door hinges.
- 4.2.7** Plan where harness supports will be located. Use a support approximately every 6 inches unless the harness routes under the floor carpet.
- 4.2.8** Allow enough slack in the harness at places where movement could possibly occur
- 4.2.9** The wires should be bundled into harness groups. Use tape, nylon ties or poly split loom.

4.3 A/C COMPRESSOR CLUTCH SIGNAL

- 4.3.1** For those running A/C, a signal wire, supplied in the bag kit, will need to be added to the ECM. **This is NOT a power wire for your A/C compressor.** This wire will provide a power signal from the A/C compressor to the ECM and will raise the engine idle speed up to compensate for the extra load the A/C compressor puts on the engine when the compressor is engaged. This signal will also activate the cooling fans to turn ON.
- 4.3.2** **Locate pin location #18 on the RED ECM connector.** Using a small screw driver, press the cover/terminal lock locking tangs and pull up with your fingers at each end of the Red terminal cover/lock to remove it.
- 4.3.3** The **GREEN** wire provided in the bag kit has an ECM terminal pre-installed. Insert this wire into pin location #18. It will make a little bit of pressure to push it through the silicone seal. The seal can be pre-punctured with a pick, tack, paperclip, or anything else small enough to fit the hole if desired.
- 4.3.4** Once the wire is inserted into the ECM connector, re-install the red terminal cover/lock, it is keyed and can only go on one way.
- 4.3.5** Decide on where the **GREEN** wire will connect to the A/C compressor activation wire. This can be done inside the vehicle at the A/C switch, if the switch is controlling power, or in the engine compartment at the A/C compressor.

If this wire is being connected at the switch, simply route this **GREEN** wire from the ECM to the big main break out on the harness roughly 10" away from the ECM. You can then route this wire to its connection point after ECM has been mounted.

If this wire is going to be connected at the A/C compressor, route the **GREEN** wire from the ECM, down the main harness, through the grommet, to the Passenger side connections. The passenger side can be identified by the "Pass. Coils" tag and the tags with the even number injectors. This **GREEN** wire will route along these connections and exit out past the "INJ. #2" connector.

5. GENERAL INSTALLATION INSTRUCTIONS

CAUTION:

- **DO NOT DISCONNECT THE BATTERY OR THE COMPUTER CONNECTORS WHILE THE IGNITION IS ON.**
- **DO NOT SHORT ANY WIRES IN THIS HARNESS TO GROUND (WITH THE EXCEPTION OF LABELED GROUND WIRES) OR DAMAGE TO THE COMPUTER WILL RESULT.**
- **GIVING OR RECEIVING A "JUMP START" MAY DAMAGE THE COMPUTER.**
- **DO NOT USE A TEST LIGHT WHEN TESTING COMPUTER SENSORS OR COMPUTER CIRCUITS. DAMAGE TO THE COMPUTER WILL RESULT!**
- **WHEN ROUTING THE WIRES FOR THE VEHICLE SPEED SENSOR (IF USED) MAKE CERTAIN THAT THEY ARE AT LEAST 12 INCHES AWAY FROM ANY IGNITION WIRING (SPARK PLUG WIRES, ETC.).**

NOTES:

- There is a normal, small current drain on these fuel injected systems.
- Each connector in this harness is different and will not fit in the wrong place. **NEVER FORCE ANY CONNECTOR.**
- When connecting the plugs to the computer **USE EXTREME CARE** to make sure none of the pins in the computer are or become bent.
- The fuel pump and pressure regulator you are using **MUST** maintain a constant pressure of **55-60 PSI** (pounds per square inch). If using a higher pressure pump you must add an inline regulator to bring the pressure down to the 55-60 range since the LS1 fuel system does not have a built-in regulator on the fuel rail as in many earlier GM fuel injection systems.

5.1 GROUNDING THE VEHICLE

A perfectly and beautifully wired vehicle will nevertheless have problems if everything is not properly grounded. Don't go to the effort to installing a quality wire harness only to neglect proper grounding.

Note: The installer of this harness is responsible for all ground wires not provided with this part.

- 5.1.1 Connect a ground strap or cable (minimum of a 4 Ga. wire) from the negative battery terminal to the chassis (frame).
- 5.1.2 Connect a ground strap (minimum of a 4 Ga. wire) from the engine to the chassis (frame). **DO NOT RELY UPON THE MOTOR MOUNTS TO MAKE THIS CONNECTION.**
- 5.1.3 Connect a ground strap from the engine to the body.

5.2 ROUGH INSTALLATION

CAUTION: DISCONNECT THE POWER FROM YOUR VEHICLE BY REMOVING THE NEGATIVE BATTERY CABLE FROM THE BATTERY.

Note: Make no wire connections or permanent mounting of any kind at this time.

- 5.2.1 Position the computer and sensors in their intend locations.
- 5.2.2 Drill a 1-5/8" hole for the firewall grommet near the computer for the engine group and tail section to pass through.
- 5.2.3 Route the engine group and tail section through the hole. Push the grommet (already installed on the harness) into the hole until it is seated.
- 5.2.4 Route the dash group over to the driver's side of the car.
- 5.2.5 Route the fuse block and relays to the place they will be mounted.

5.3 HARNESS ATTACHMENT

Note: Harness routing and shaping will be a time-consuming task. Taking your time will enhance the beauty of your vehicle. Please take your time and be patient.

- 5.3.1 Permanently mount your computer. You should mount the fuse block and relays at this time.
- 5.3.2 Mold harness groups to the contour of the dash, engine, frame, etc. Remember to route harness away from sharp edges, exhaust pipes, hinges, and moving parts.

5.3.3 Attach harness groups to your vehicle with clips or ties starting at the computer and working your way outward.

Note: Do not tighten tie wraps or mounting devices at this time. Make all harness attachments LOOSELY.

5.3.4 When used every 1-1/2" or so on the visible areas of the harness, colored plastic wire ties make a very attractive assembly. Otherwise, a tie installed in other areas every 6" or so will hold the wires in place securely. **REMEMBER TO TAKE YOUR TIME.**

5.4 TERMINAL INSTALLATION INSTRUCTION

Note: In the following steps you will be making the circuit connections. Before you start, you should carefully read Sections 6.0, and continually refer to the wire charts, **DOUBLE CHECKING** your length calculations before cutting any wire or making any connections. These directions are for the wires, which do not have a connector already, installed on them.

5.4.1 Have all tools and connectors handy.

5.4.2 Select the correct terminal for the wire and application.

5.4.3 Determine the correct wire length and cut the wire. Remember to allow enough slack in the harness and wires at places where movement could occur. **DOUBLE CHECK YOUR CALCULATIONS.**

5.4.4 Strip insulation away from wire. Only strip as much insulation off as necessary for the type of terminal lug you are using.

Note: In the following step, make sure that the terminal is crimped with proper die in the crimping tool. An improper crimp will not make a good connection. **DO NOT OVER-CRIMP.**

5.4.5 Crimp the terminal onto the wire.

5.4.6 Connecting the wires and connectors throughout the harness is a simple process. Make sure that each wire is properly routed and then attached. **DO NOT ATTACH THEN ROUTE AFTERWARD.**

5.4.7 When all the wires are attached, tighten the mounts and ties to secure the harness permanently.

5.4.8 Attach the connectors to the computer. **BEING VERY CAREFUL NOT TO BEND ANY PINS.**

5.4.9 After all connections have been made throughout the harness, connect the battery to the vehicle.

CAUTION: BE SURE THE IGNITION IS OFF WHEN YOU RECONNECT THE BATTERY OR YOU WILL DAMAGE THE COMPUTER.

6. INSTALLATION

6.1 KIT CONTENTS

Take inventory to see that you have everything you are supposed to have in this kit. Should you notice something missing, contact the dealer where you obtained the kit or Painless Performance at (817) 244-6898. The kit should contain the following items:

- The main wire harness with the connectors already on the ends of most of the wires.
- Fuel Injection Installation Instructions **P/N 90520** (This Booklet).
- 4" & 7" tie wraps.

6.2 SPECIFIC CIRCUIT CONNECTIONS

Note: If you have not already done so, read sections 4.0 and 5.0 of these instructions and think through the installation of the harness before securing or cutting any wires.

6.2.1 DASH SECTION INSTALLATION

The wires in this group consist of the diagnostic link connector (DLC) (SEE **FIGURE 6.1**), the check engine light (pre-mounted into a mounting bracket), and 14 other wires.

Note: You may need to connect the check engine light wires to their mates in the wire harness.

CAUTION: DO NOT MAKE ANY CONNECTIONS WHILE THE COMPUTER IS PLUGGED INTO THE HARNESS.

Note: Wire color (Example: Blk/Wht) is one wire with a stripe. The second color (the stripe) may not be bold. Observe all two-color wires closely.

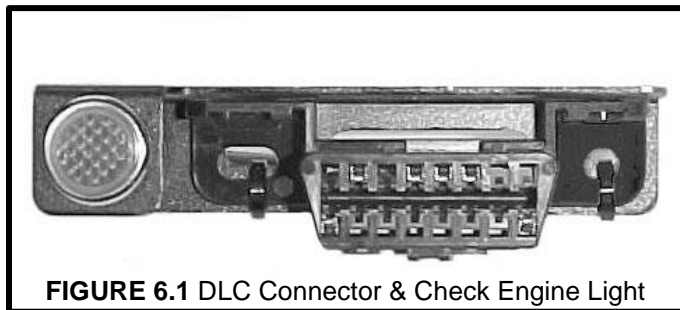

FIGURE 6.1 DLC Connector & Check Engine Light

- A. Find a suitable location to mount the DLC connector (using the bracket that the light is mounted in) that will allow access to the front of the connector and still allow you to see the light while driving.
- B. Mount the DLC connector using the bracket containing the check engine light in the place selected.
- C. Locate the **PINK** ignition hot activation wire, labeled FUSE BLOCK IGNITION (18 Ga.) and attach it to a 12V **fused** source where there is power **WHEN THE KEY IS IN THE START AND RUN POSITION**. This wire activates the relays that supply power to all the ignition hot circuits in the fuel injection harness. If the **PINK** wire is connected correctly, the check engine light will come on when the ignition switch is in the "ON or START" position.
- D. Locate the ORN/BLK and BLK/WHT wires in the dash group. These two wires are for the Gear **INDICATOR** Switch, **NOT** the Neutral Safety Switch. If you have a GM column then you can use the combination switch Delco P/N D2286A and wire it as described in paragraph 2 or 3 below. The **ORN/BLK** wire needs to be grounded in "Park and Neutral" and ungrounded in "Drive". This can also be done with a toggle switch or a switch on the parking brake.

NOTE: The ORN/BLK and BLK/WHT wires are only needed if using a 4L60E transmission. If you are using a manual transmission then you will tape and stow these wires.

CAUTION: DO NOT CONNECT THESE WIRES USING DIRECTIONS FROM DIFFERENT PARAGRAPHS. YOU MAY DAMAGE THE COMPUTER.

- D.1. The recommended switch is a combination reverse light, gear indicator **AND** neutral safety switch. You may use it for all these purposes if you wire it **EXACTLY** as shown in **Figure 6.4 Illustration B**
- D.2. If you are going to use the recommended switch as a gear indicator for the computers benefit **ONLY**, then you will wire it as shown in **Figure 6.4 Illustration A**.
- D.3. You may want to install your own switch. This switch must connect the ORN/BLK wire to ground only when the car is in **PARK OR NEUTRAL**. You may or may not want to use the BLK/WHT wire. The other end of the BLK/WHT wire is already grounded throughout the harness.
- E. The **PURPLE** and **PINK** wires labeled BRAKE SWITCH are the wires that connects to the brake switch to let the computer know when the brake is applied. If you **ARE NOT** using a 4L60E then you will tape off and store these wires. If you **ARE** using the 4L60E transmission then you will have to install an electrical switch described in **Paragraph 4.1.2**. The **PINK** wire provides power for this switch and the **PURPLE** wire is the signal going to the computer.
- F. If you are using the recommended brake switch then you will wire it according to **Figure 6.2**. The **PINK** wire to the back of the switch in the illustration is the wire that has power on it whether or not the brake is being applied.

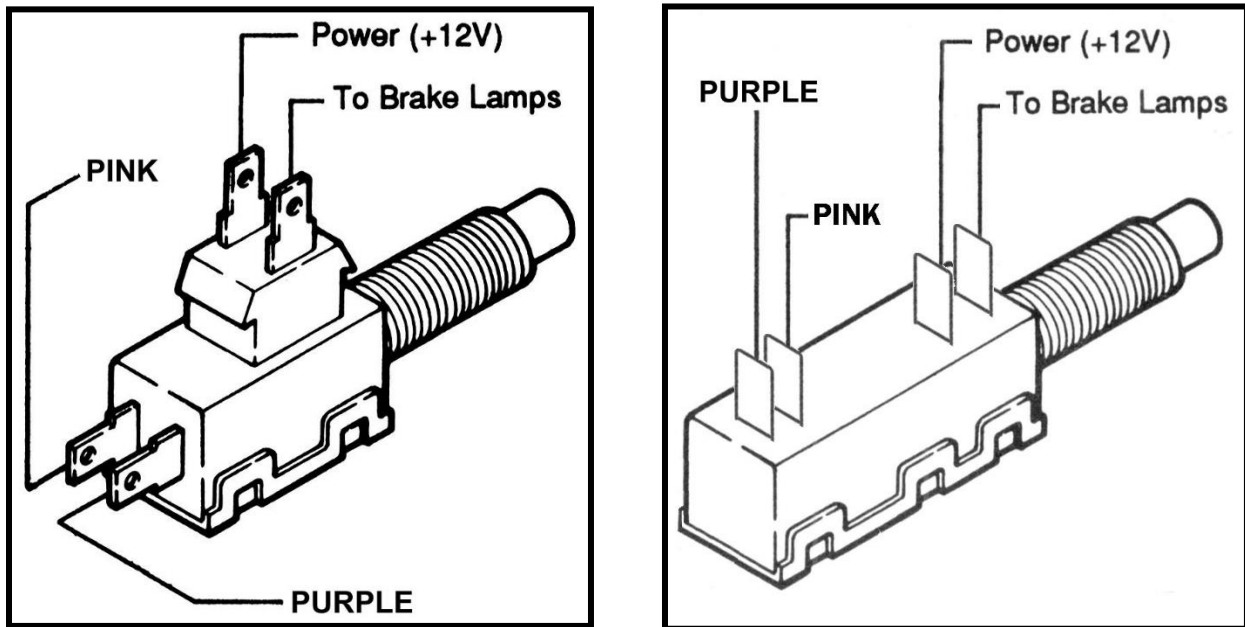

FIGURE 6.2 Brake Switch Connections

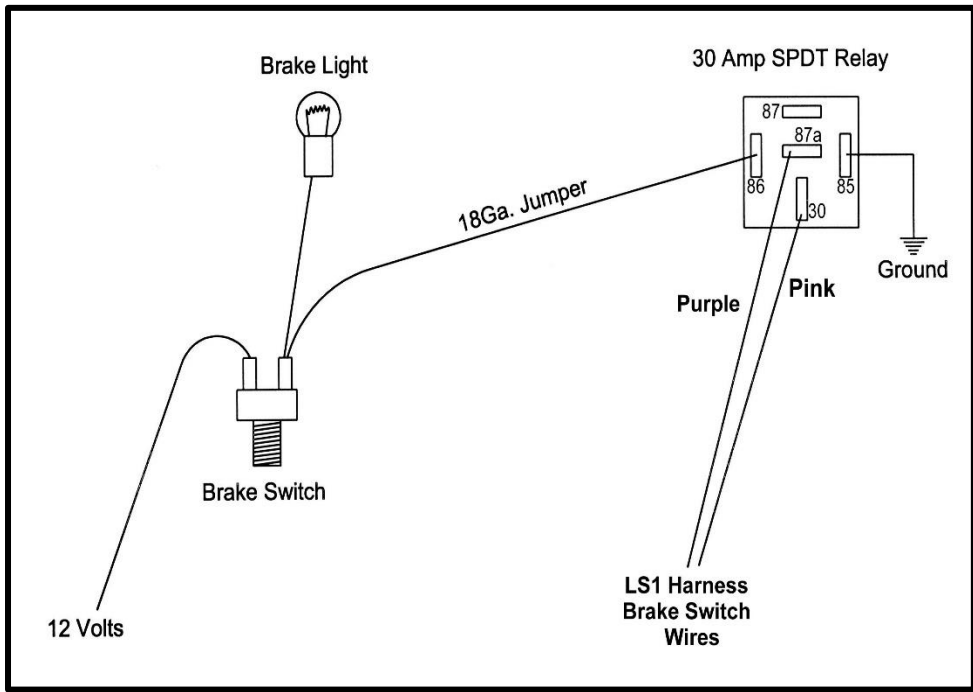

FIGURE 6.3 Brake Switch Relay

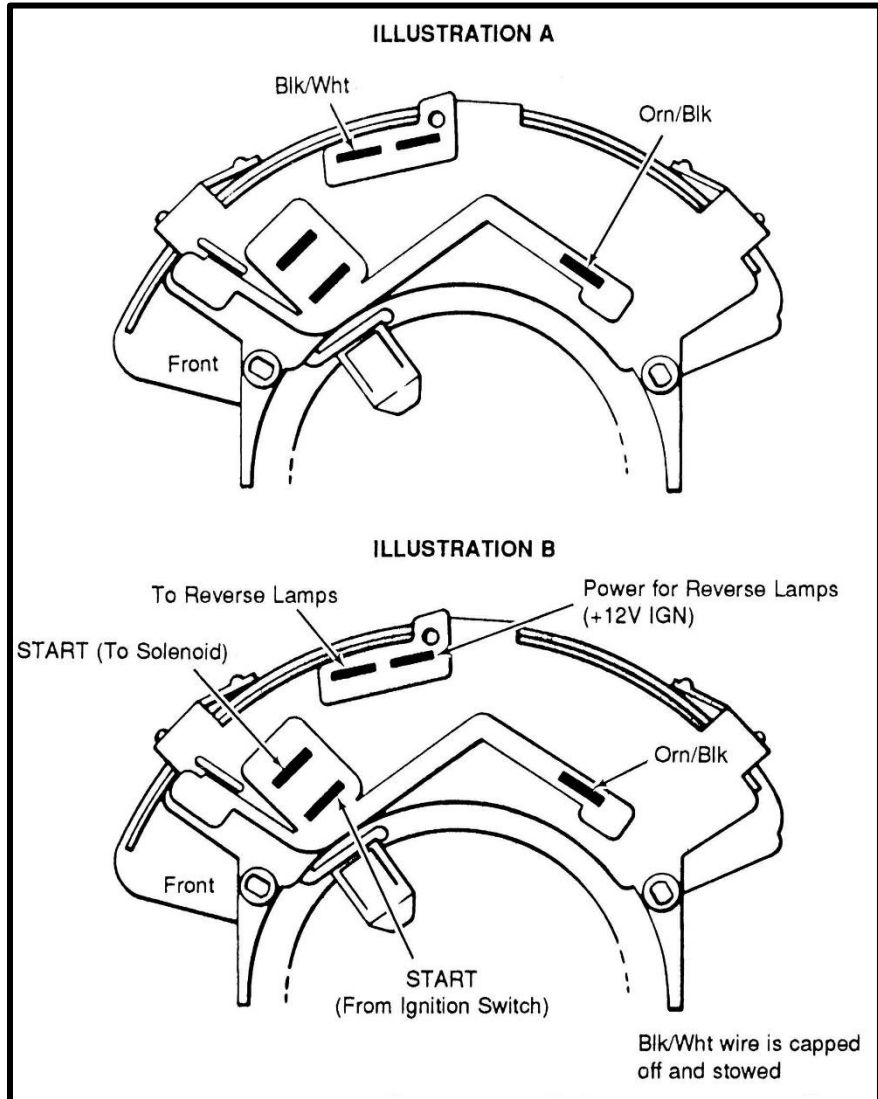

FIGURE 6.4 Gear Indicator Switch

CAUTION: FAILURE TO WIRE THIS SWITCH CORRECTLY WILL RESULT IN A DANGEROUS SITUATION ON THE VEHICLE.

G. If your vehicle has a pressure type brake switch, you may use a relay as shown in **Figure 6.3**. The relay must be a **SPDT Relay** and wired correctly or it could result in a dangerous situation with the vehicle. The torque **converter may not unlock**.

The wire labeled FUEL TEST is a test point for the fuel pump. After the vehicle has been wired and tested OK, tape off this wire and store it in the harness.

I. Fan #1 relay wire (**GREEN**) and fan #2 relay wire (**BLUE**) are relay ground wires activated by the computer.

NOTE: Fan #1 will come ON at 226°f and go OFF at 217°f. Fan #2 will come ON at 235°f and go OFF at 226°f.

J. The wire labeled TACH (**WHITE**) is the signal wire for a tachometer if used.

K. The VSS output wire (**GREEN/WHITE**) sends out a signal to operate the electronic cruise control or speedometer if so equipped.

L. The wire labeled SKIP SHIFT LIGHT (**WHITE/BLACK**) is only used with the T56 manual transmission. The computer grounds this wire to turn on the skip shift light if used.

M. The fuel pump relay is activated by the ECM and will send power to an electric fuel pump. Mount the relay and insert the supplied relay into this connector.

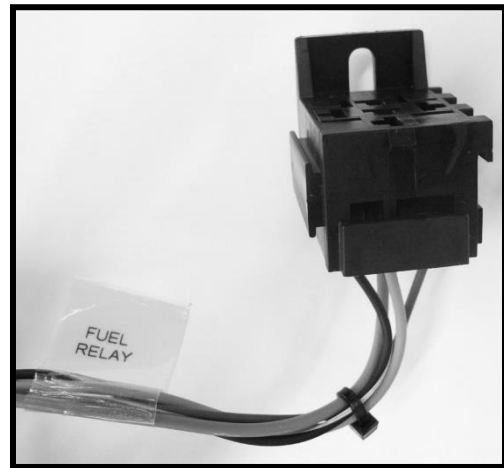

FIGURE 6.5 Fuel Pump Relay Connector

6.2.2 Dash Section Connections

<u>WIRE COLOR</u>	<u># OF POSITIONS IN CONNECTOR</u>	<u>LABELED</u>	<u>CONNECT TO:</u>
GRAY, GREEN/WHITE, BLACK, ORANGE	4	Fuel Relay	Fuel Pump Relay
GREEN/WHITE		VSS Output	Speedometer
WHITE		Tach	Tachometer
ORANGE/BLACK, BLACK/WHITE		Gear Indicator Switch	Gear Indicator Switch
PINK, PURPLE		Brake Switch	Brake Switch
PINK		Fuse Block Ignition	Ignition Power
GREEN		Fan #1 Relay	Coolant Fan #1 Relay
BLUE		Fan #2 Relay	Coolant Fan #2 Relay
WHITE/BLACK		Skip Shift Light	Skip Shift Light (T56 Trans. Only)

TABLE 6.1 Dash Section Connections

6.3 ENGINE GROUP INSTALLATION

The engine group is designed to be separated into left side (driver) and right side (passenger) sections. Each side is tie-wrapped separately, **BUT NOT LABELED**. The left side of the engine has the connectors for the idle air control, throttle position sensor, and engine coolant sensor, all of which **ARE** labeled. When you begin routing, **FIRST** separate the engine group into left and right sections and place them accordingly.

- 6.3.1** Before you connect any wires, separate the tail section from the engine group and place it out of the way.
- 6.3.2** Connect the two ring terminals labeled STARTER B+ with **RED** wires to the large battery terminal on the starter solenoid.
- 6.3.3** Locate the three large ring terminals with **BLACK** and **BLK/WHT** wires and ground them to the engine. These must be on 3 separate bolts, **DO NOT CONNECT ALL TO THE SAME GROUNDING POINT**. Under no circumstance should all 3 ring terminals be connected to the same bolt.
- 6.3.4** Using **Figure 6.11-6.25**, and the specific connections indicated in **Table 6.2A or 6.2B**, connect the wiring as directed.

NOTE: The air pump, air bleed solenoid, canister purge solenoid and canister vent solenoid connectors are rolled up in the dash section and must be routed out to the engine compartment if these items are to be used.

6.3.5 Engine Section Connections

<u>WIRE COLOR</u>	<u># OF POSITIONS IN CONNECTOR</u>	<u>LABELED</u>	<u>CONNECT TO:</u>
BLUE, LT. BLUE	2	Knock	Knock Sensor
TAN/WHITE, PURPLE/WHITE, BLACK, PINK	4	Drvr Side Oxy	Driver Side Oxygen Sensor
TAN, PURPLE, BLACK, PINK	4	Pass Side Oxy	Pass Side Oxygen Sensor
ORANGE/BLACK, LT. GREEN, GRAY	3	MAP	MAP Sensor
BROWN/WHITE, RED, PINK/BLACK	3	CMP	Cam Position Sensor
BLUE/WHITE, YELLOW/BLACK, LT. GREEN	3	CKP	Crankshaft Position Sensor
PINK, BLACK	2	Inj. #1	Driver Front Injector
PINK, LT. GREEN/BLACK	2	Inj. #2	Pass. Front Injector
PINK, PINK/BLACK	2	Inj. #3	Driver 2 nd Injector
PINK, LT. BLUE/BLACK	2	Inj. #4	Pass. 2 nd Injector
PINK, BLACK/WHITE	2	Inj. #5	Driver 3 rd Injector
PINK, YELLOW/BLACK	2	Inj. #6	Pass. 3 rd Injector
PINK, RED/BLACK	2	Inj. #7	Driver Rear Injector
PINK, BLUE/WHITE	2	Inj. #8	Pass. Rear Injector
BLUE, BLACK, GRAY	3	TPS	Throttle Position Sensor

<u>WIRE COLOR</u>	<u># OF POSITIONS IN CONNECTOR</u>	<u>LABELED</u>	<u>CONNECT TO:</u>
YELLOW, BLACK/WHITE, PINK	3	MAF	Mass Airflow Sensor
BLACK, YELLOW	2	ECT	Engine Coolant Temp Sensor
PURPLE, TAN	2	IAT	Intake Air Temp Sensor
LT. GREEN/BLACK, LT. BLUE/BLACK, LT. BLUE/WHITE, LT. GREEN/WHITE	4	IAC	Idle Air Control Motor
PURPLE, RED, GREEN, LT. BLUE, BROWN, BLACK, PINK	7	Drvr Coils	Driver Side Coil Conn.
RED/WHITE, PURPLE/WHITE, LT. BLUE/WHITE, GREEN/WHITE, BROWN/WHITE, BLACK, PINK	7	Pass Coils	Pass Side Coil Conn.
BLACK (3), BLACK/WHITE (2)		Ground	Engine Ground
RED (2)		Starter B+	Starter Solenoid Batt. Terminal

TABLE 6.2 Engine Section Connections

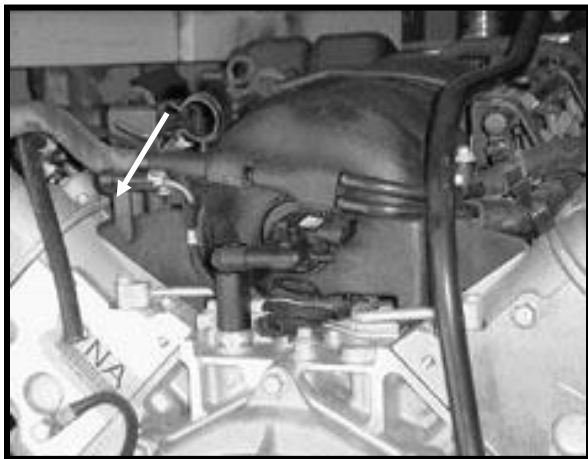

FIGURE 6.6 Knock Sensor Connector

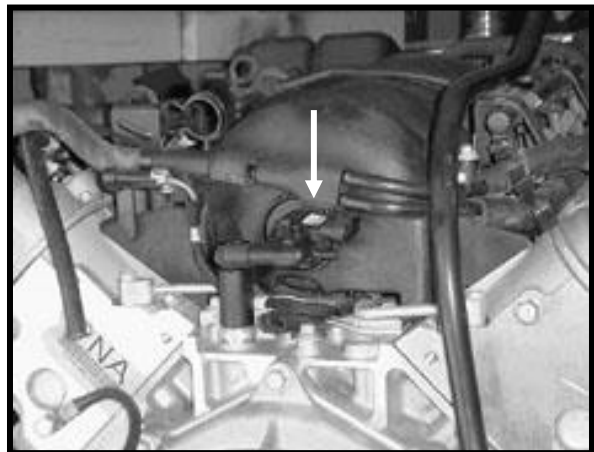

FIGURE 6.7 MAP Sensor

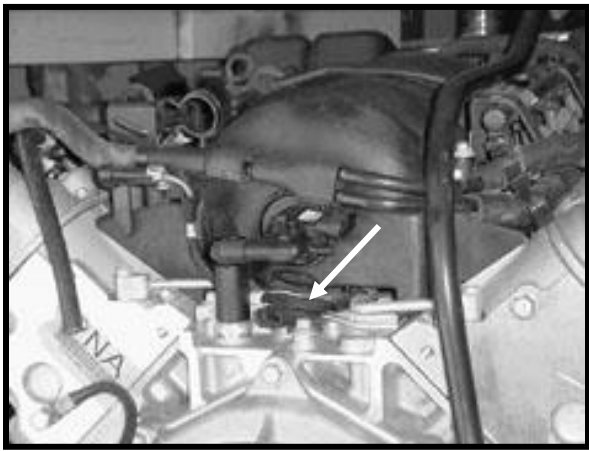

FIGURE 6.8 Cam Position Sensor

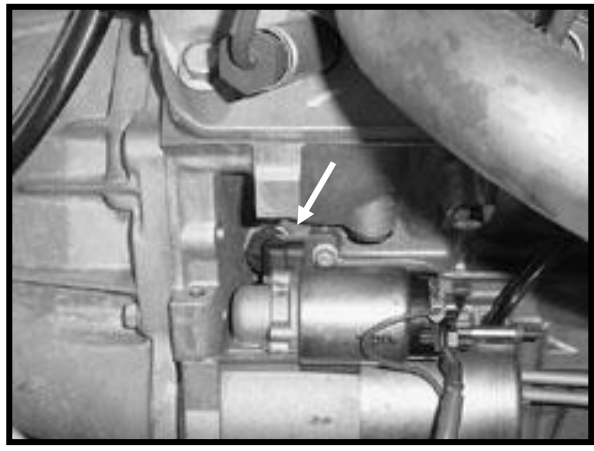

FIGURE 6.9 Crank Position Sensor

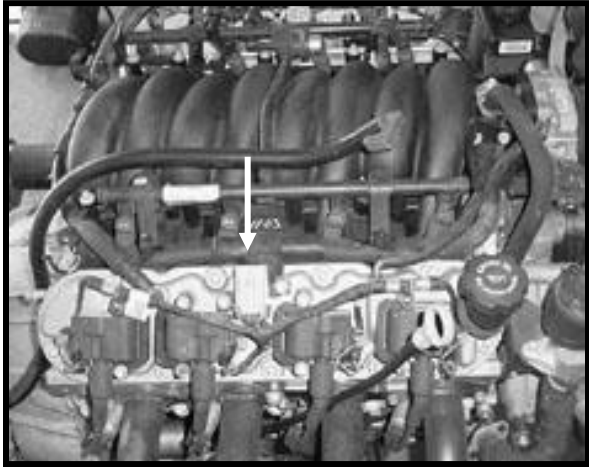

FIGURE 6.10 Passenger Side Coil Connector

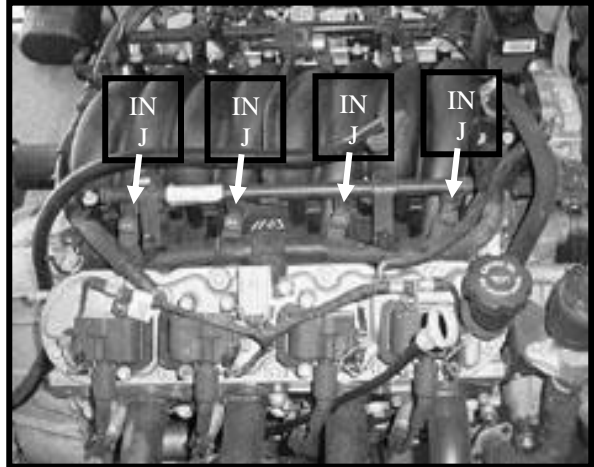

FIGURE 6.11 Injectors 2, 4, 6, 8

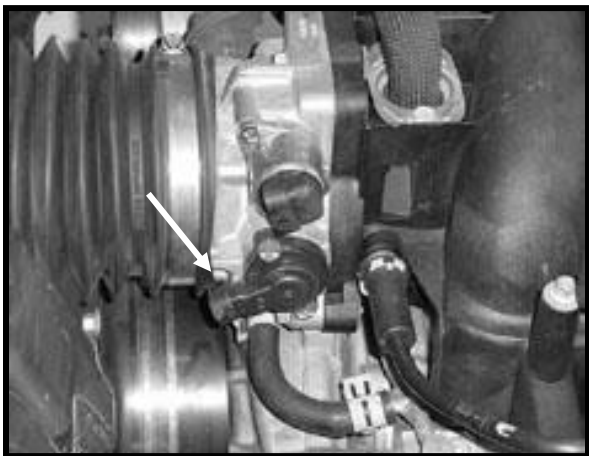

FIGURE 6.12 TPS Sensor

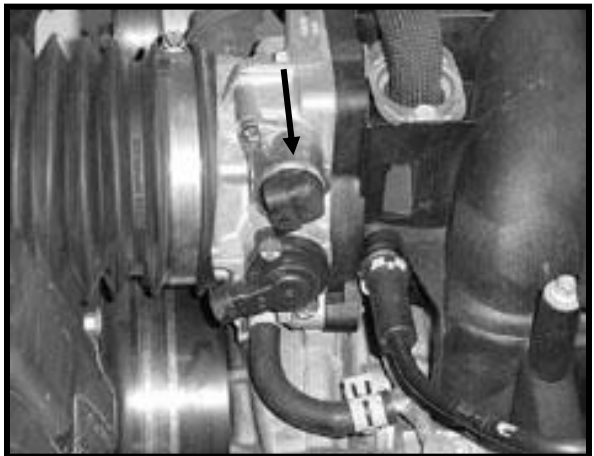

FIGURE 6.13 IAC

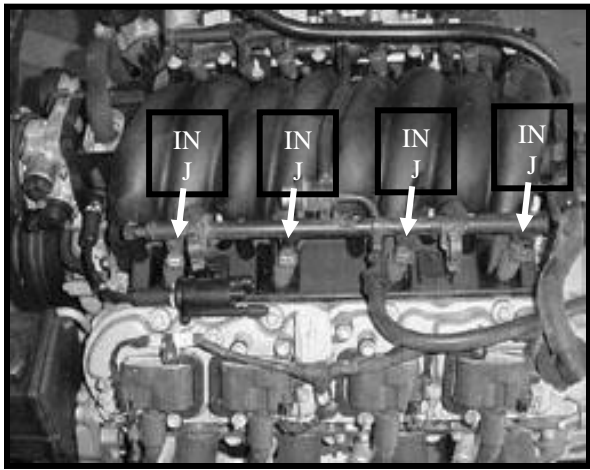

FIGURE 6.14 Injectors 1, 3, 5, 7

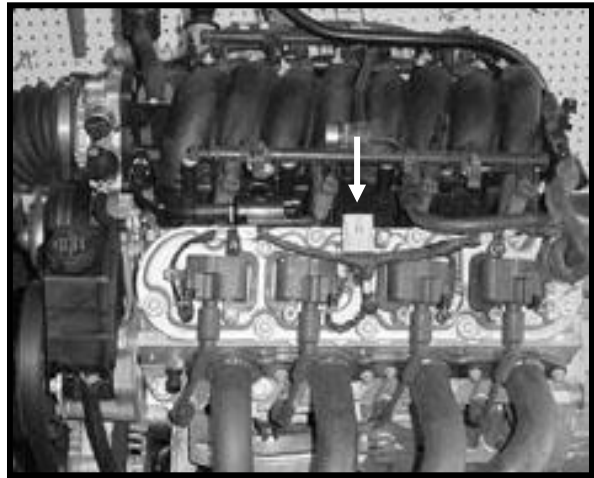

FIGURE 6.15 Driver Side Coil Connector

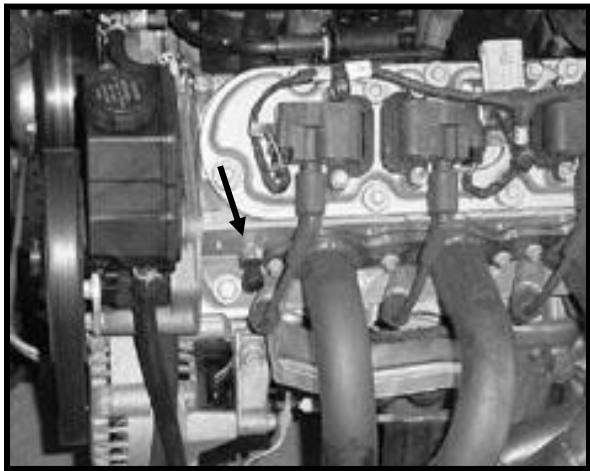

FIGURE 6.16 ECT Sensor



FIGURE 6.17 MAF Sensor



FIGURE 6.18 IAT Sensor

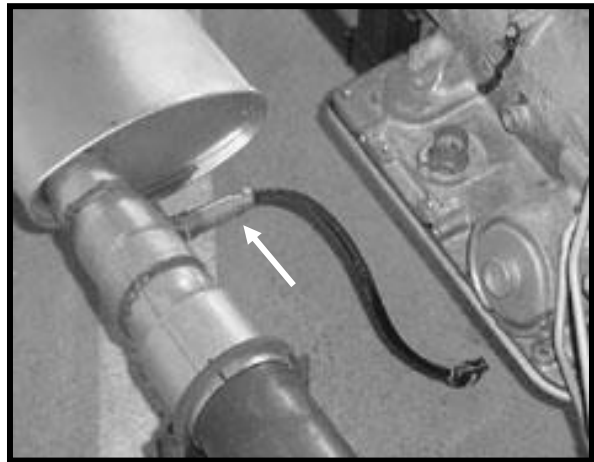

FIGURE 6.19 O2 Sensor

6.4 TAIL SECTION INSTALLATION

- 6.4.1** Locate the tail section that you earlier separated from the engine group. Begin routing it towards the rear of the vehicle. Be sure to avoid all sharp edges, moving or hot parts, or anything else that may damage the harness.
- 6.4.2** If you **ARE** using the 4L60E transmission, route the 13-position connector to the transmission and attach it. Tape up the reverse lockout and skip shift solenoid connectors and store them in the harness.
- 6.4.3** If you **ARE** using the T56 manual transmission, route the reverse lockout and skip shift solenoid connectors to the transmission and attach them. Tape up the 13-position connector labeled TRANS and store it in the harness.
- 6.4.4** Take the connector for the Vehicle Speed Sensor (VSS) and connect to the Vehicle Speed Sensor.
- 6.4.5** Take the gray wire labeled FUEL PUMP and route it to the fuel pump. This is the power wire for the fuel pump.

6.4.6 Tail Section Connections

<u>WIRE COLOR</u>	<u># OF POSITIONS IN CONNECTOR</u>	<u>LABELED</u>	<u>CONNECT TO:</u>
PURPLE/WHITE, LT. GREEN/BLACK (60508)	2	VSS	Vehicle Speed Sensor
PINK, LT. GREEN	2	Reverse Lockout Sol.	Reverse Lockout Solenoid
PINK, GRAY	2	Skip Shift Sol.	Skip Shift Solenoid
BLUE, PINK (2), LT. GREEN, RED, BROWN, YELLOW/RED, ORANGE/BLACK, WHITE, TAN/BLACK, LT. BLUE/WHITE, RED/BLACK, YELLOW/BLACK	13	Transmission	Transmission
GRAY		Fuel Pump	Fuel Pump Power Terminal

TABLE 6.3 Tail Section Connections

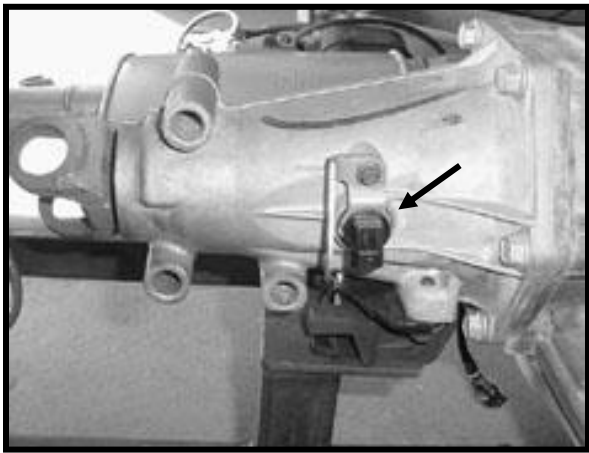

FIGURE 6.20 VSS (4L60E)

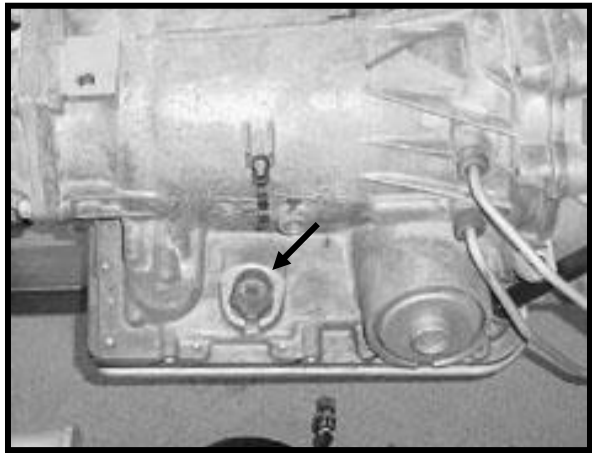

FIGURE 6.21 Transmission Connection (4L60E)

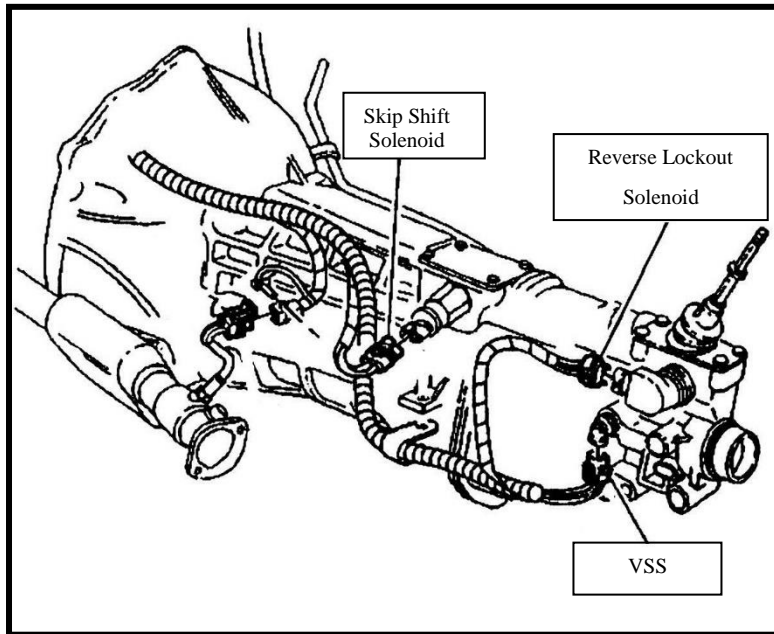

FIGURE 6.22 Transmission Connections (T56)

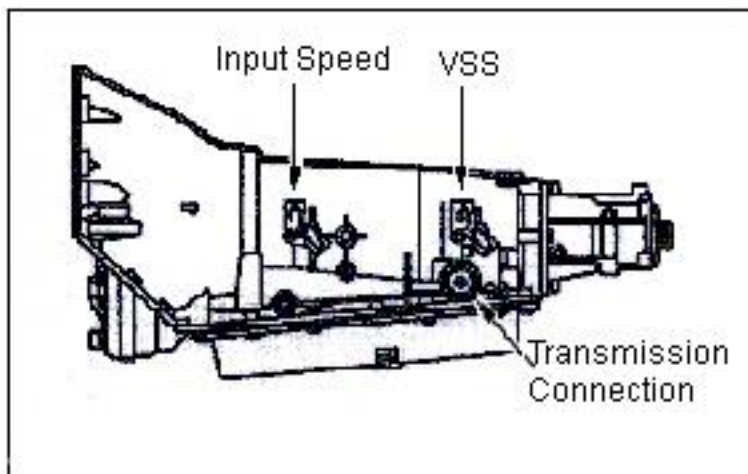

FIGURE 6.23 VSS & Input Speed Sensor, Transmission Connection(4L80E)

6.5 Modifications for use of a 4L80e Transmission

NOTE: A custom ECM tune will be needed in order to run ECM flashed with a LS1 operating system as these engines were never factory equipped with a 4L80e transmission. Harness numbers 60508 and 60509 have the transmission connector pre terminated to allow use of a 4L60E transmission. In applications where a 4L80e is to be used, follow this procedure to change your transmission connector to ensure all functions of the transmission work properly. See Figure 6.24 for repinning the transmission connector. The supplied input speed sensor pigtail from the parts kit will also need to be added to the ECM/ harness. See Figures 6.25 & 6.26 for Input Speed Sensor add on.

6.5.1 Transmission connector Re-Pin

- A. With the terminal end of the connector and the arrow on top pointing towards you, carefully remove the **WHITE** retaining lock located in the center of the connector.
- B. Locate the **WHITE** wire located in terminal location S. Using a paper clip or small screwdriver, gently lift the locking tab inside the connector and pull the wire from its location.
- C. Now locate the **BROWN** wire located in terminal location U. Using the same method, remove the **BROWN** wire from it's location
- D. Gently insert the **BROWN** wire into terminal location S.
- E. The **WHITE** wire has no function with the 4L80E transmission; it needs to be taped up and stowed in the harness in case a 4L60E is ever to be used.

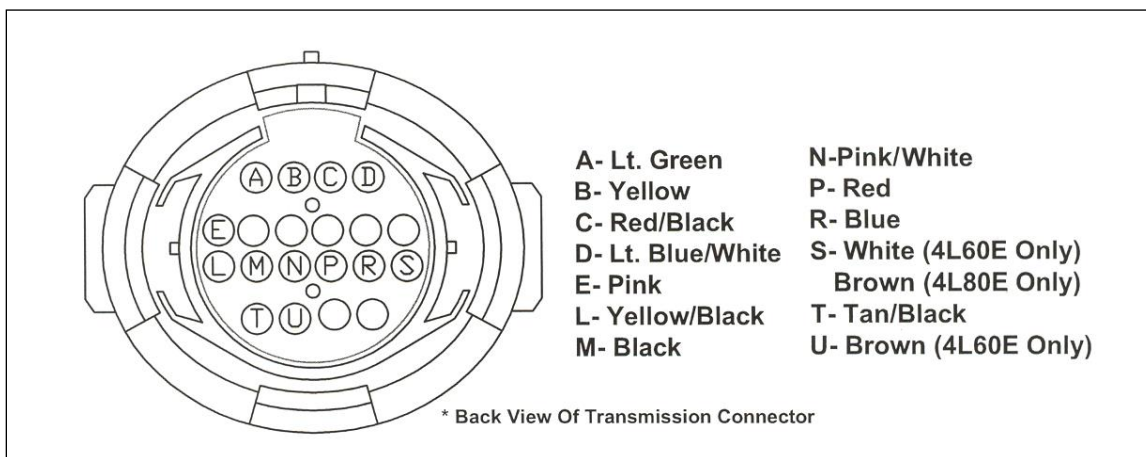

Figure 6.24 Transmission Connector Pin Out

6.5.2 Adding the Input Speed Sensor Connection

The 2-wire supplied Input Speed Sensor pigtail will need to be added to the harness as the 4L80e has an additional sensor that the 4I60e does not have. Wires from the pigtail have been pre-terminated and have had the appropriate connector pre-installed. You the installer must simply install the 2 terminals into the **RED** ECM connector and route the connector to the transmission.

A. Locate the **RED** ECM connector. Looking at the wire insertion side of the connector, identify pin locations #22 and #23. These locations will be empty.

B. Using a small screw driver, press the locking tang on one side of the terminal lock and pull the lock away from the connector. Once one side is done, do the other side as well to completely remove the lock from the connector. You only need to remove the lock from side of the connector with pins 22 and 23. See Figure 6.25

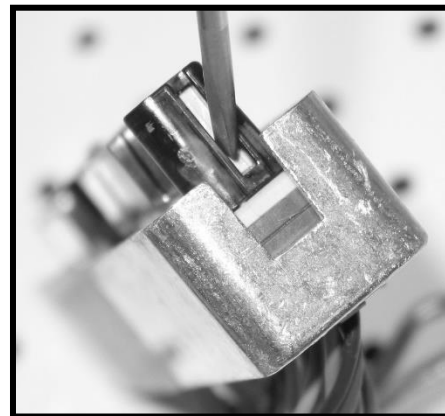

Figure 6.25 ECM Terminal Lock

C. Locate the Input Speed Sensor pigtail supplied with this kit. This pigtail will have a **RED/BLACK** and **BLUE/WHITE** wires. Plug the **RED/BLACK** wire into pin #22 and the **BLUE/WHITE** wire into pin #23. Re-install the **RED** terminal lock., see figure 6.26.

D. Route the pigtail with the other transmission wires to the transmission and connect it to the Input speed sensor, located towards the front of the transmission, see figure 6.23. Please be aware that this connector is also the same connector that plug into the VSS sensor, do not mistakenly plug the Input Speed sensor into the VSS on the rear of the transmission and or the VSS connector into the Input Speed Sensor.

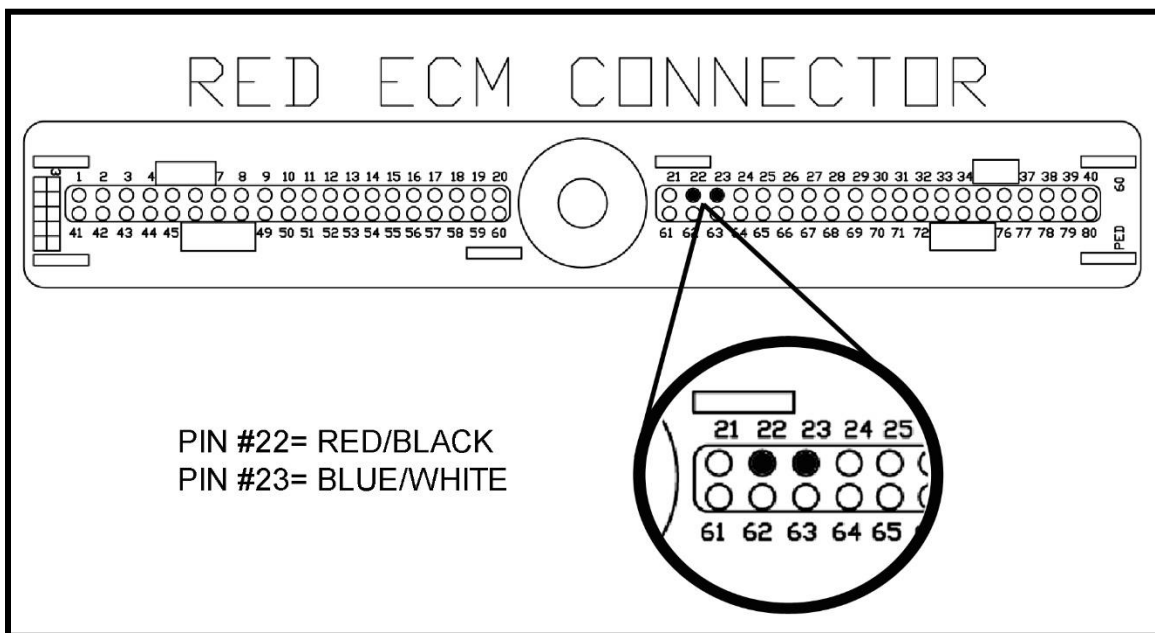

Figure 6.26 Input Speed Sensor Connection to ECM

7. TROUBLE- SHOOTING INSTRUCTIONS

If you are having trouble with your engine running badly or not running at all, first perform basic trouble-shooting (ensure that you are using the correct parts (Table 4.1), check for faulty connections, blown fuses, , spark, timing, fuel pressure, etc.), then see if the computer has stored a trouble code in its memory.

7.1 THE "CHECK ENGINE" LIGHT

Normally, the "check engine" light should come on when the ignition is turned on, then go out a few moments after the engine starts running. If it reappears, or stays on while the engine is running, the computer has detected a problem and a trouble code has been set.

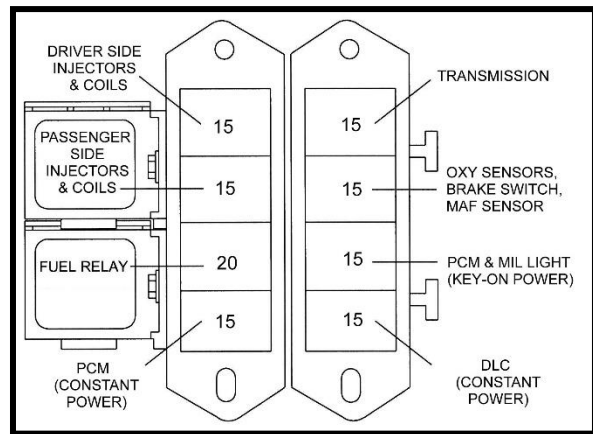

FIGURE 7.1 60508/60509 Fuse Identification

NOTE: Most likely the check engine light will come on and stay on when using a computer with the original factory programming this is normal and is why we recommended that the computer be reprogrammed to remove any items that the factory vehicle had that aren't being used in the vehicle you are installing the engine into.

7.2 RETRIEVING TROUBLE CODES FROM THE COMPUTER

7.2.1 In order to retrieve the trouble codes stored in the computer, a scanner must be connected to the Assembly Diagnostic Link (DLC) connector (installed and connected in **Paragraph 6.2.1**). Follow the instructions provided with the scanner to read the codes set in the computer.

7.2.2 After you have read any codes, write them down for reference. Remove the connector from the DLC connector.

7.2.3 Take the codes one at a time and match them to the codes in a Camaro/Firebird repair manual. This will tell you which circuit the computer has detected a problem.

Note: **A code indicates a problem in a specific circuit, NOT THAT A PARTICULAR PART IS BAD.**

7.2.4 Before taking more extensive corrective actions for any trouble codes make sure that all connections on the indicated circuit, **INCLUDING THE COMPUTER**, are clean and tight. Inspect the wiring in the circuit for any broken, shorted, or exposed wires. Finally, ensure all ground wires are clean and secure.

7.2.5 If a trouble code is detected and the problem has been fixed, clear the codes by first making sure the ignition is off then disconnecting the **NEGATIVE** battery cable for at least 3 minutes.

7.3 TROUBLE SHOOTING GUIDE FOR YOUR PAINLESS PERFORMANCE HARNESS

If you have installed your harness, made all the connections as outlined in the installation manual, and utilized the correct components as shown in the compatible parts list, the engine should start and run. If you are experiencing difficulties in getting the engine started, this trouble shooting guide should help you in diagnosing the problem.

- **FIRST AND FOREMOST, DO NOT TRY AND START YOUR ENGINE WITHOUT INSTALLING AND CONNECTING ALL OF THE COMPONENTS.** Attempting to do so will result in a “no start” situation. This includes things like the O2 sensors, knock sensors, the “PRNDL” switch (if it applies to your harness), relays, and the ECT. It’s easy to try and skip connections just to see the engine fire up, but this could cause countless difficulties trying to diagnose the issue.
- Before you attempt to start the engine, be sure that you have the correct ECM for your harness. The correct ECM is listed in the “compatible Parts List” on **page 8**. Also, make sure that the ECM you are using has been programmed by someone who is familiar with the programming procedures required for the ECM used in an engine transplant. There is more involved in programming for an engine transplant than just turning off the vehicle anti-theft. It is important to have someone who knows these tuning procedures so that you can be confident your ECM’s programming is correct for your application.

The first things to check if you are experiencing a “no start” situation, and your ECM has been programmed properly, are the battery (+) power to the harness and the grounds. Make sure the grounds are not stacked with each other. They can be on the same head or block area but should be bolted separately, not on top of each other. Also make sure that your vehicle is grounded properly, or your grounds will not do you any good. This means the negative battery cable should be bolted to the block or the frame using a star washer. The star washer allows your ground cable to cut through any paint and makes direct contact with the metal. Then, a ground strap (also using star washers) should be bolted from the block to the frame. Last, there should be a small ground strap from the block or head to the firewall. Only when these grounds are in place will the grounds for your harness be correct.

The battery (+) power to the harness should only come straight from one end of the positive battery cable, either at the battery or at the starter. The constant battery power is what provides power to the harness for the computer (ECM) memory. If it is not going to the positive battery cable, the ECM will have to relearn initial startup procedures every time you start it.

Last, make sure that the wire tagged “**12v IGN.**” wire is connected to an ignition hot source that has power **BOTH** in the ON/RUN position as well as the START position. An easy way to tell if you connected the wires to the correct power source is to look at the check engine light.

The check engine light has a direct correlation with the “**12v IGN.**” wire. If this wire is connected to the correct power source, the check engine light will come on when the key is turned to the ON/RUN position and will stay on when the key is turned all the way to the START position. If the light goes out in either of these ignition switch key positions, this means you are losing power to the “12v IGN” wire and must find another power source for it. The engine will never fire and start if this wire does not have the proper power source.

Also, make sure your check engine light is connected to the harness at the ALDL bracket. If you think you have connected the “**12v IGN.**” wire properly, and still do not have a check engine light when you turn the key on, check to see if the light is connected to the harness. Sometimes, the harnesses are not plugged into the light. The wires that connect to the light (**PINK** and **BROWN**) are tied together near the light. They are terminated so you can connect them to the 2 **BLACK** wires coming from the light.

FUEL PRESSURE: If you have checked all of the constant/switched power and your grounds but still have a “no start” problem, move onto the fuel system. The fuel pump should come on for a few seconds when you turn the key on and then shut off. This is to pressurize the fuel system, prepping it for start. If you turn the key on and do not hear the fuel pump come on and cycle, you need to check the fuel pump relay.

Make sure (as mentioned earlier) that the relay is plugged into the base. If it is plugged in properly, check to see if the relay might be defective. To do this, put 12 volts to the short wire marked “Test” coming out of the relay base. This wire is the same color as the wire providing power to the fuel pump. This “Test” wire will bypass the relay and apply 12 volts directly to the pump. If the fuel pump comes on when the 12 volts is applied, this tells you the relay is defective and needs to be replaced.

If your fuel pump does cycle with the key on you should check the fuel pressure. The fuel pressure should be about 58 to 60lbs. If it is not, you need a fuel pump that will deliver enough pressure to the injectors and the engine to run.

INJECTORS: LS injectors are susceptible to gumming up and sticking when the engine is left sitting for long periods of time (a year or more) with old fuel sitting in them. It is suggested that you clean the injectors if you do not know how long the engine has set.

If your injectors are clean and free, check to see if you have injector pulse. The best way to do this is to use a “NOID LIGHT” which can be found at any auto parts store. They are inexpensive and easy to use; you can buy a single light for the fuel injection system you are working on. Or you buy a set of 8 that will have a light for many different types of injectors. OEM offers singles (#25143 for the LS injectors) and Performance Tool offers a set of 6 (#W89500).

The light plugs into the injector connector. If you are getting an injector signal from the ECM, the light will flash. If the noid light does not flash, you are not getting the proper injector pulse signal from the ECM. This could be because the ECM is not getting the proper signal from the crankshaft position sensor, the ECM may have a bad driver, or one of the relays is either defective or not installed in the fuse block properly. These relays also control the coil power, and that is the next thing to check.



FIGURE 7.2 Noid Light

SPARK: if you have checked and cleared all of the previously mentioned components and still have a “no start” condition, you need to check for spark at the coils. You will need to test for 12 volts at the colored wire going to each coil. Then, check for continuity of the ground on the **BLACK** wire going to each of the coils. If you do not have continuity to ground on the **BLACK** wires, check the harness to the coils and the plug in the Painless harness to the coils. If all looks good there, you need to follow that wire back to its splice and then to the ground at the back of the block. Also, make sure the ground at the block is not stacked with any other ground on that bolt.

If all these things check out, you should be getting air/spark/fuel and that is what it takes to fire your engine. Remember, it does not pay to try and start your engine without everything installed and connected as it leads to undue frustrations.

7.4 WHEN TO CALL PAINLESS PERFORMANCE PRODUCTS' TECH LINE

- 7.4.1** These harness kits have been built with the highest regard to quality control. Before calling us please double check all connections and perform normal basic trouble-shooting (fuel pressure, timing, ignition system, etc.).
- 7.4.2** If you have any questions concerning the installation of this harness or having trouble in general, feel free to call Painless Performance Products' tech line at (817) 423-9696. Calls are answered from 8am to 5pm central time, Monday thru Friday, except holidays. Email questions to support@painlessperformance.com

Painless Performance Products, LLC **Limited Warranty and Return Policy**

Chassis harnesses, fuel injection harnesses, and Trail Rocker units are covered under a lifetime warranty.

All other products manufactured and/or sold by Painless Performance are warranted to the original purchaser to be free from defects in material and workmanship under normal use. Painless Performance will repair or replace defective products without charge during the first 12 months from the purchase date. No products will be considered for warranty without a copy of the purchase receipt showing the sellers name, address, and date of purchase. You must return the product to the dealer you purchased it from to initiate warranty procedures.