



DODGE RAM 2500/3500 4WD DIESEL BODY LIFT INSTALLATION INSTRUCTIONS 2003 / 2004 KIT #60113

⚠WARNING

Installation of a Performance Automotive Group body lift will change the center of gravity and the handling characteristics of the vehicle. Because of the higher center of gravity and larger tires, the vehicle will handle and react differently both on and off road. You must drive it safely! Extreme care must be taken to prevent vehicle rollover or loss of control, which could result in serious injury or death. Avoid sudden sharp turns or abrupt maneuvers and always make sure all vehicle occupants have their seat belts fastened.

⚠WARNING

Read and understand all instructions, warnings, cautions, and notes in this sheet and in your owners manual before you begin the installation of this body lift kit.

⚠CAUTION

Proper installation of a Performance Automotive Group body lift kit requires knowledge of the factory recommended procedures for disassembly and assembly of original equipment components. We recommend that the factory shop manual and any special tools necessary to your vehicle be on hand during the installation. Installation of this body lift kit without proper knowledge of the factory recommended procedures may affect the performance of these components and the safety of your vehicle. We strongly recommend that a certified mechanic familiar with the installation of similar components install this body lift kit.

⚠WARNING

Many states now have laws restricting bumper heights and vehicle lifts. Local laws should be consulted to determine if the changes you intend to make to your vehicle comply with state laws. Before combining a body lift with a suspension lift, consult an installation professional to see how this will affect your specific application.

⚠WARNING

The installation of larger wheel and tire combinations may reduce the effectiveness of the braking system.

⚠WARNING

This body lift kit should only be installed on vehicles in good working condition. Before installation, the vehicle should be thoroughly inspected for evidence of corrosion or deformation of the sheet metal around the factory body mounts. This body lift kit should not be installed on any vehicle that is suspected to have been in a collision or misused. Off road use of your vehicle with this body lift installed may increase the stress applied to the factory body mounts. We do not recommend that any vehicle with a body lift installed be involved in any extreme off road maneuvers such as jumping. Failure to observe this warning may result in serious personal injury and/or severe damage to your vehicle.

⚠WARNING

Always wear eye protection when operating power tools.

⚠WARNING

Ensure that your vehicle tires are properly blocked and secured before you begin installation of this lift kit.

⚠WARNING

The Supplemental Restraint System (SRS, or air bag) must be deactivated during lift kit installation to avoid accidental air bag deployment while working near SRS sensors and wiring. Do not allow anyone near the air bag during lift kit installation. Accidental deployment can result in serious personal injury or death. Refer to your factory service manual/owner's manual for the recommended procedure to disable the SRS. The SRS must be reactivated before driving the vehicle.

⚠NOTE

Performance Automotive Group recommends using the Loctite® supplied in the kit on all hardware unless noted in the instructions.

A. Before you start.

⚠ NOTE

Kit parts are prefaced by the word *kit* in italics.

1. Carefully read all warnings and instructions completely before beginning.
2. Verify all parts have been received in this kit by checking the parts list at the end of this document.

⚠ NOTE

If parts are missing from kit, please be prepared to provide the following information:

1. **Name** of purchase location
 2. **Bar Code** on side of box
 3. **Date** above bar code
 4. **Date** inside box cover
 5. **Inspector #** from inside box cover
3. **Only install this kit on the vehicle for which it is specified.** If anytime during the installation you encounter something different from what is outlined in the instructions, call technical support at (928) 636-7080.
 4. Special tools needed:
 - a. Welder (or access to a professional welding shop).
 - b. Die grinder or similar tool capable of cutting metal.
 5. Park the vehicle on a clean, dry, flat, level surface and block the tires so the vehicle cannot roll in either direction.
 6. Disconnect both sets of battery cables.
 - a. Disconnect two negative cables (1) first, then two positive cables (2) from the two batteries (3).

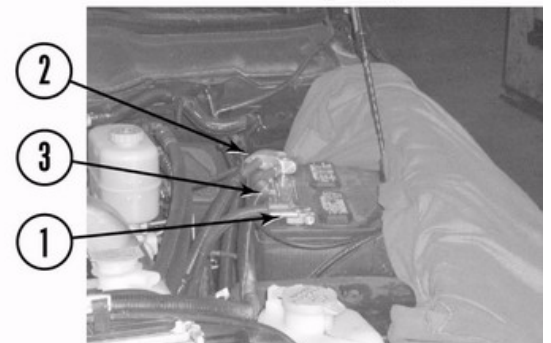
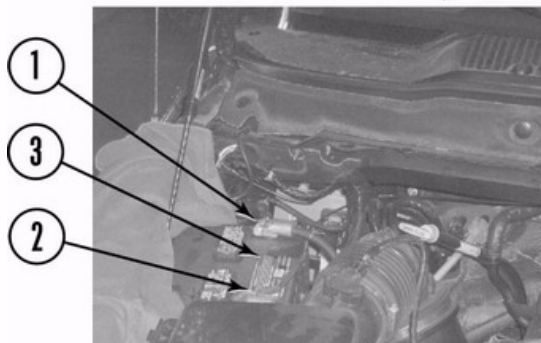

7. Remove airbag fuses.

- a. Turn thumb wheel (4), lift cover (5), and remove two air bag fuses #52 and #53 (6 and 7) from the fuse panel (8). Fuse locations may vary, so check fuse chart.

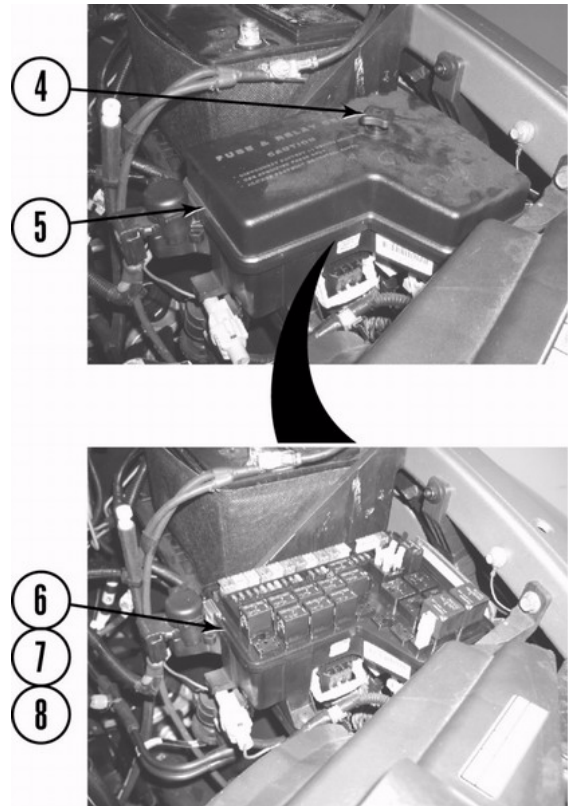

B. Get ready to install the kit.

1. Remove the front bumper.

- a. Measure distance between the front bumper (9) and front fenders (10). Record measurement.

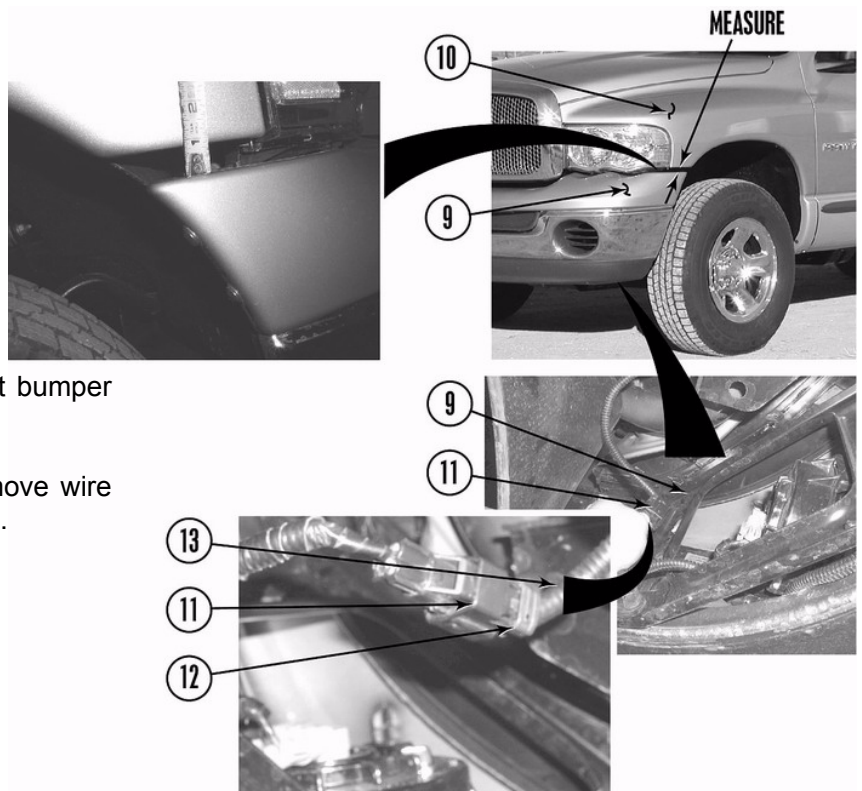

- b. Remove wire connector (11) from front bumper (9).
- c. Slide red safety latch (12) up and remove wire connector (11) from wiring harness (13).

- d. Remove four nuts (14) from two double bolt fasteners (15), front bumper (9), and frame (16).

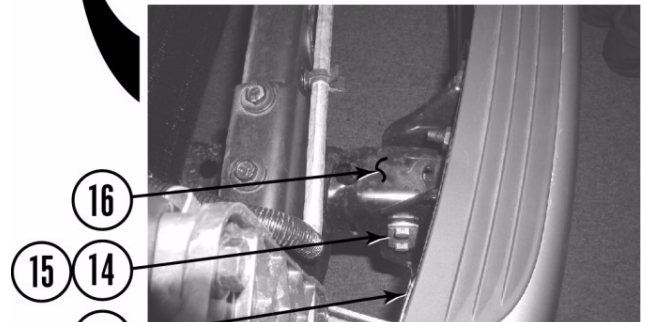

- e. Remove two bolt (17) and two upper bushings (18) from intercooler (19) and core support (20).

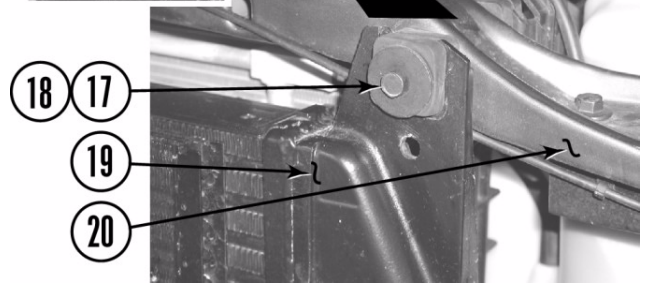

- f. Push bottom of intercooler (19) forward and up, toward front bumper (9), and remove two double bolt fasteners (15) and front bumper.

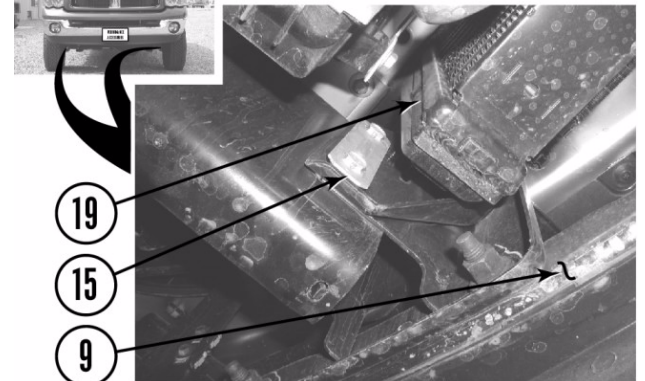

2. Remove AC condenser and intercooler.

- a. Remove four bolts (21) from AC condenser (22) and intercooler (19). Support AC condenser so that lines are not binding or kinking.

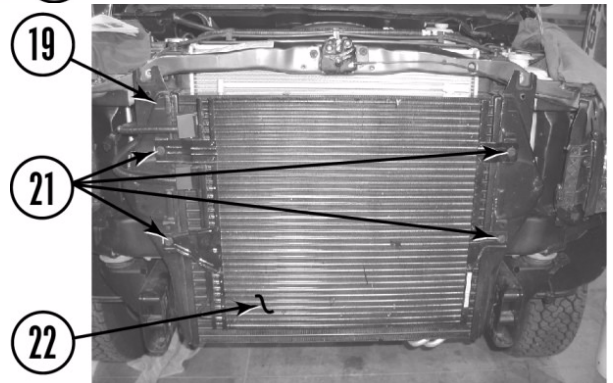

- b. Loosen two clamps (23) from intercooler (19) and two flex connectors (24). Remove intercooler from flex connectors and core support (20).

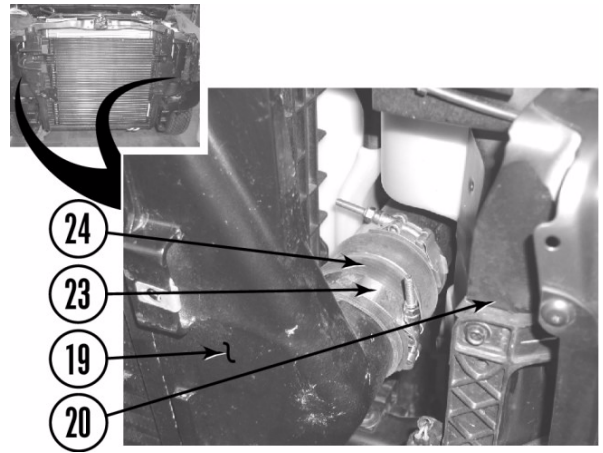

3. Remove transmission cooler.

- a. Remove two bolts (25) from transmission cooler (26) and radiator (27).

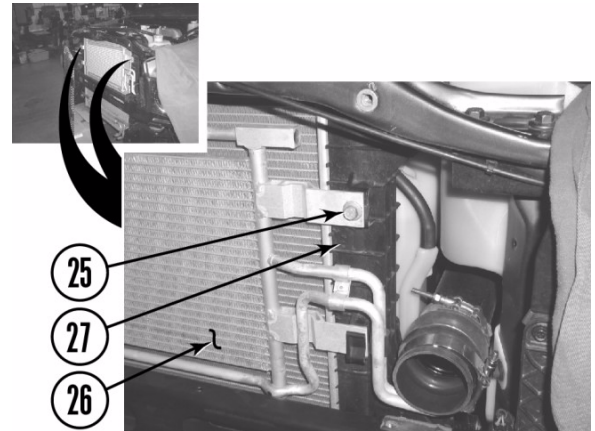

- b. Gently lift and remove transmission cooler (26) from radiator (27) and transmission cooler locking tabs (28).

- c. Temporarily support transmission cooler (26) from core support (20) with zip ties (29) as shown.

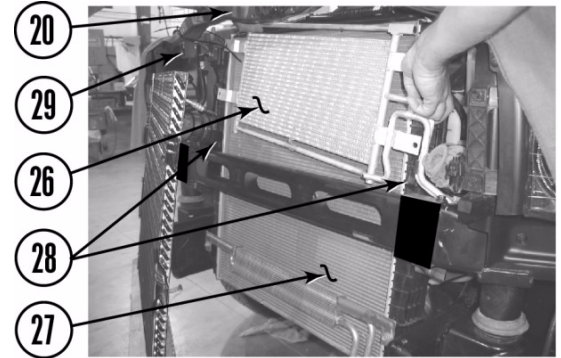

4. Remove radiator.

- a. Have at hand two of the *kit* bed crush blocks (30). Remove four bolts (31) and lower radiator support bracket (32) from core support (20) and radiator (27) passenger side.

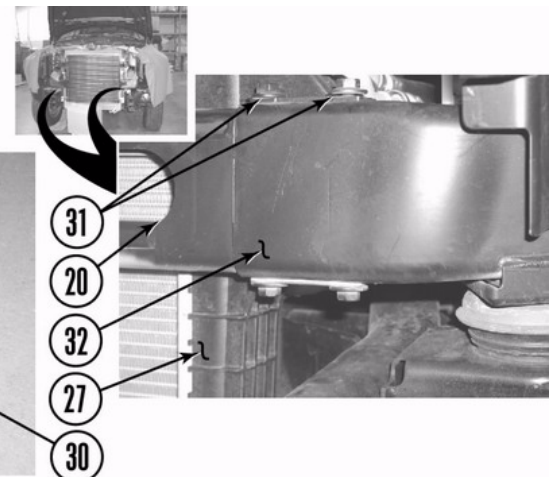
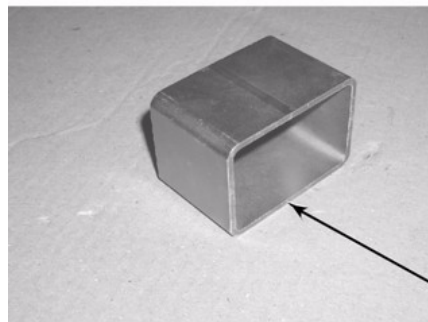

- b. Position a *kit* bed crush block (30) under radiator (27) and on top of frame (16) as shown. For temporary support of radiator only. Repeat on driver side.

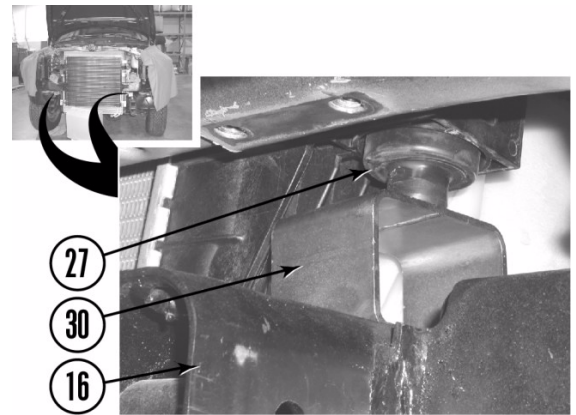

- c. Remove two transmission cooler lines (36) from bracket on radiator (27) driver side.

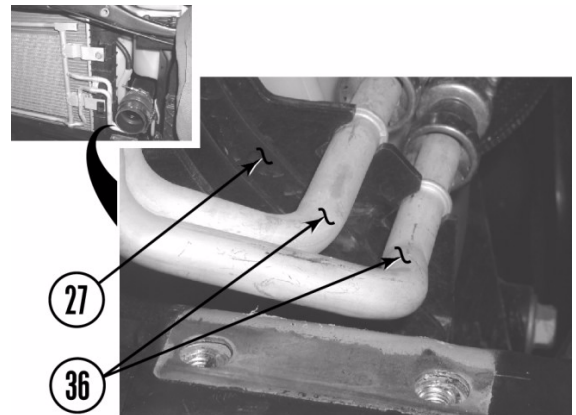

- d. Remove two upper bolt/captive washers (33) and two upper bushings (34) from radiator (27) and core support (20). Let radiator rest on *kit* bed crush blocks (30) as shown previously.

- e. Remove overflow tube (35) from radiator filler neck (27).

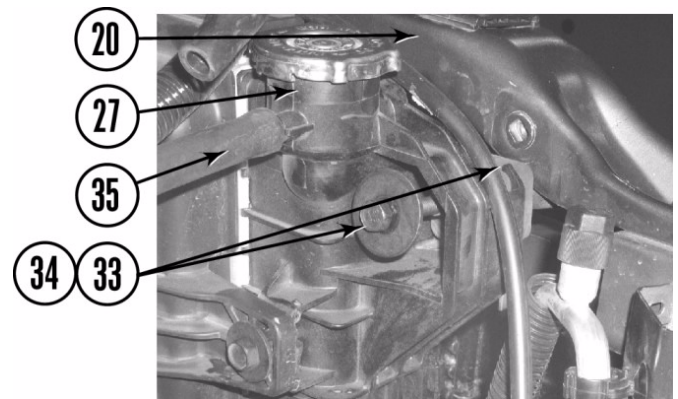

5. Under the hood. (Air filter box)

- a. Remove wiring harness clip (37), three clamps (38), hose clamp (39), and air box cover (40) from air filter (41), lower air filter housing (42), and air intake hose (43).

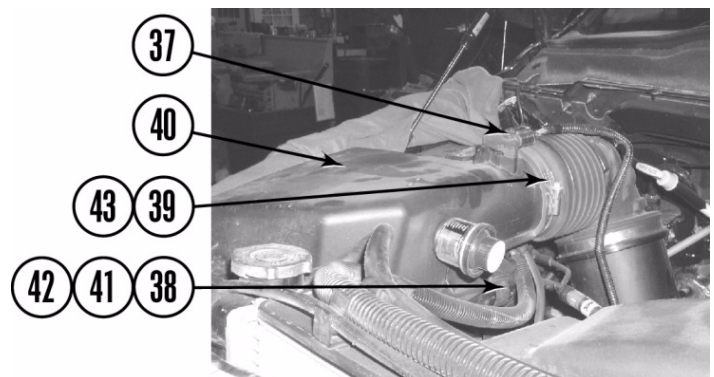

- b. Remove air filter (41) from lower air filter housing (42).

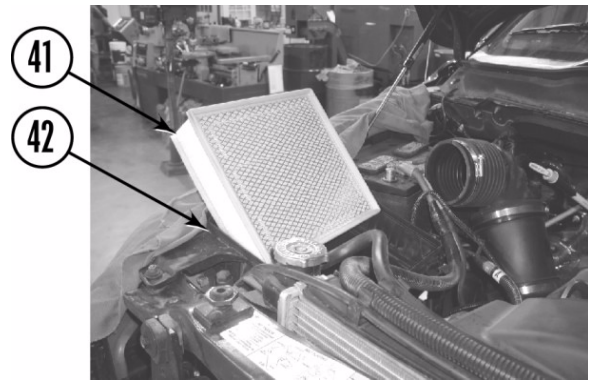

- c. Remove nut (44) and lower air filter housing (42) from bolt with stud (45) and battery box support tabs (46).



- d. Remove two push clip standoffs (47) and AC tube (48) from core support (20) passenger side.

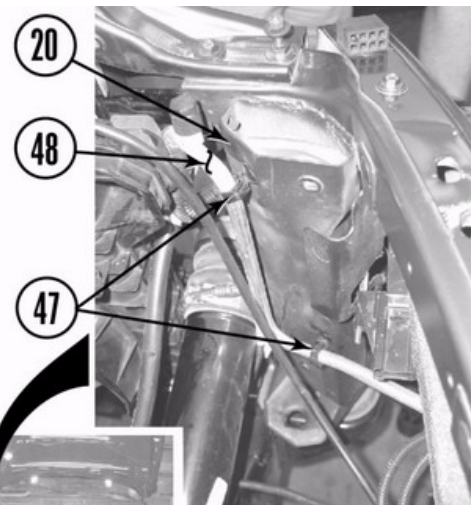

6. Under the hood. (Lower heater hose)

⚠ WARNING

If the engine cooling system is hot, the coolant will be HOT and UNDER PRESSURE. To prevent serious personal injury, wait until the cooling system is completely cool before loosening the radiator cap.

- a. Remove radiator cap. Remove two clamps (49) and lower heater hose (50) from heater core (51) and engine heater tube (52).

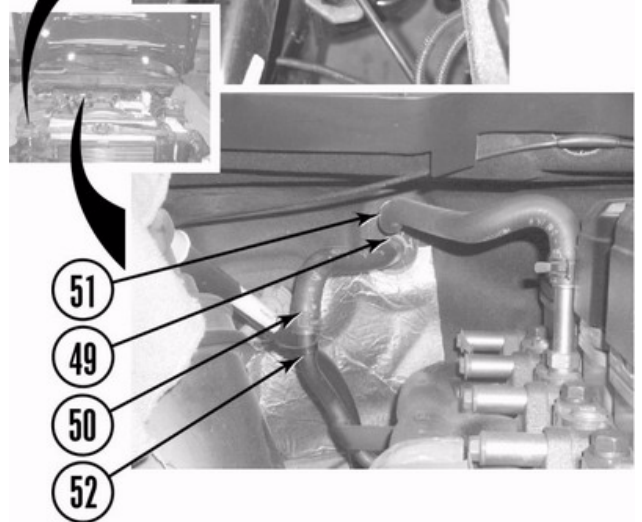

- b. Install *kit* heater hose (53) on heater core (51) and engine heater tube (52) with two *kit* #10 hose clamps (54). Hose may be slightly kinked until body is lifted.

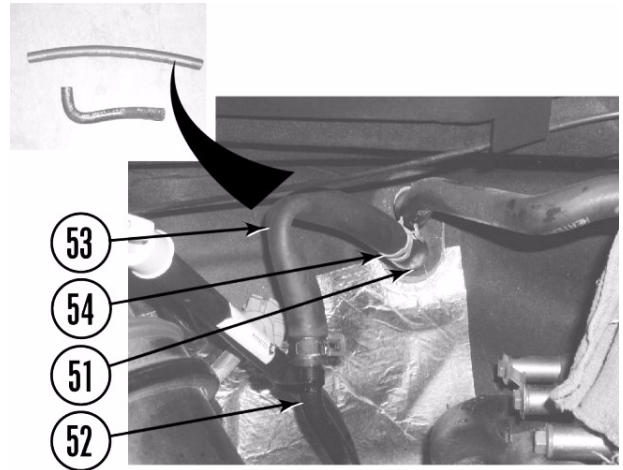

7. Under the hood. (Air inlet tube)

- a. Remove bolt (55), nut (56), three wire harness clamps (57), and push clip (58) from air inlet tube (59).

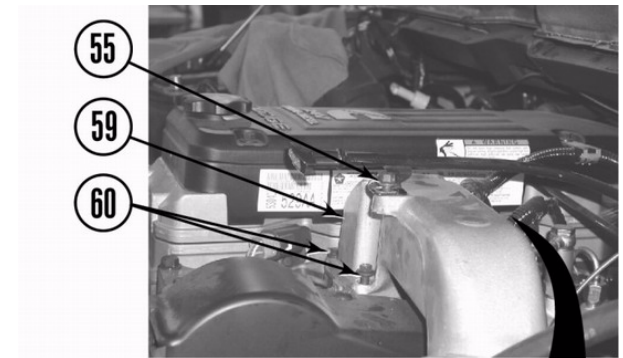

- b. Remove four bolts (60), clamp (61), and flex-connector (24) from air inlet tube (59) and intake manifold (62).

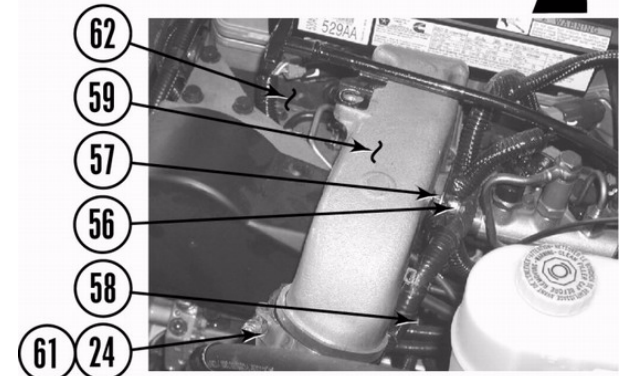

- c. Carefully remove air inlet tube (59) from intake manifold (62). Using air inlet tube as a template create a cardboard intake manifold cover (63) as shown.

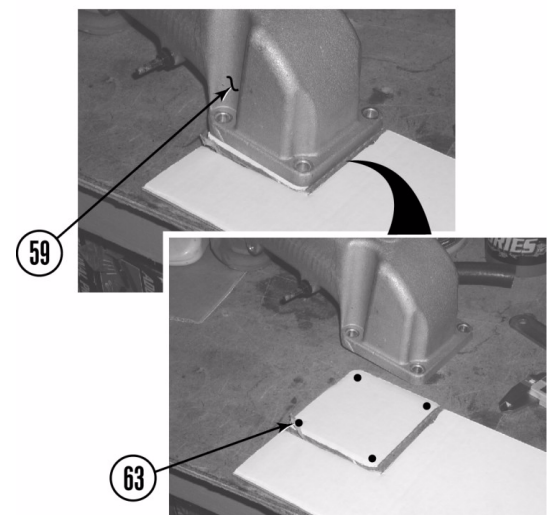

- d. Position cardboard intake manifold cover (63) over intake manifold (62) opening with four bolts (60) as shown.

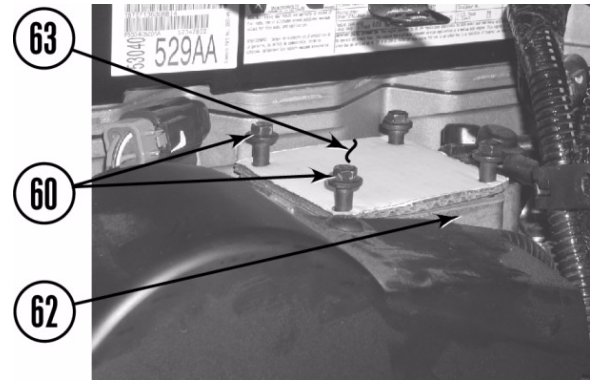

- e. Mark air duct (64) top as shown and remove from vehicle. Plug ends.

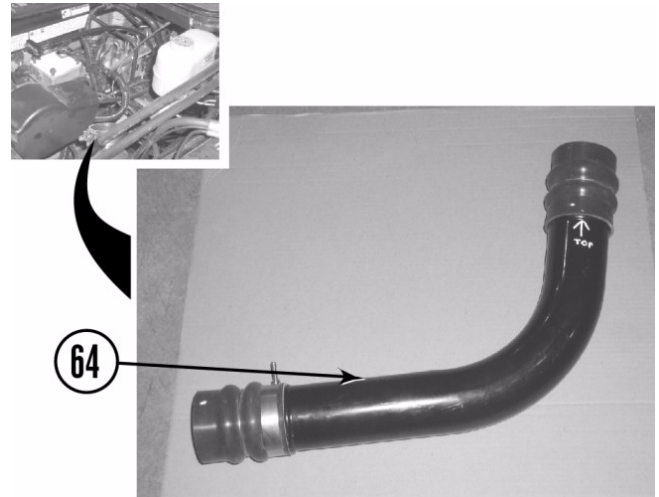

- f. Remove nut (65) and ground strap (66) from stud (67) on firewall (68).

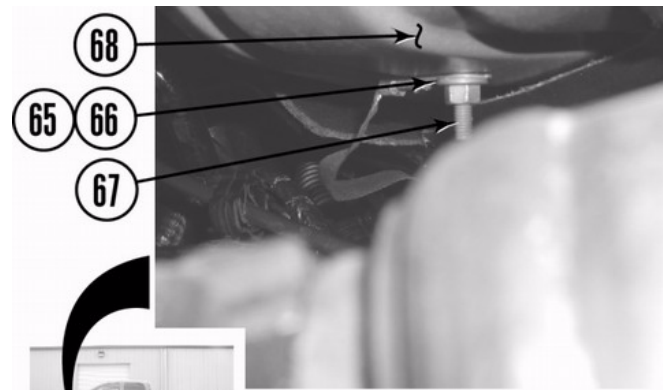

- g. Remove push clip (69) and wiring harness (70) from bracket (71) back of engine driver side.

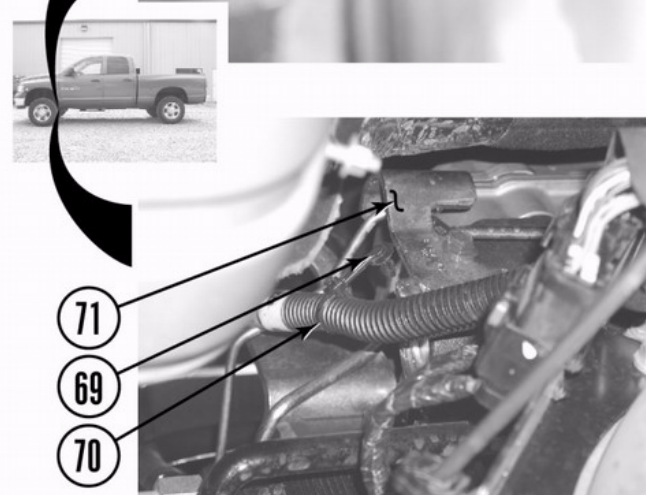

8. Disconnect steering shaft.

NOTE

Ensure steering shaft does not turn independently of the steering gearbox. This could cause the air bag system to malfunction, resulting in serious personal injury or damage to the equipment.

- a. Straighten steering wheel and strap wheel so it will not turn.
- b. Mark upper steering shaft (72) where it connects to the lower steering shaft (73).
- c. Mark lower steering shaft (73) where it connects to the steering gear box (74).
- d. Remove bolt (75) and slide upper steering shaft (72) up to separate from lower shaft (73).
- e. Upper steering shaft (72) may not separate from lower steering shaft (73), it may be necessary to remove bolt (76) and lower steering shaft from steering gear box (74). If necessary remove lower steering shaft from upper steering shaft and vehicle.

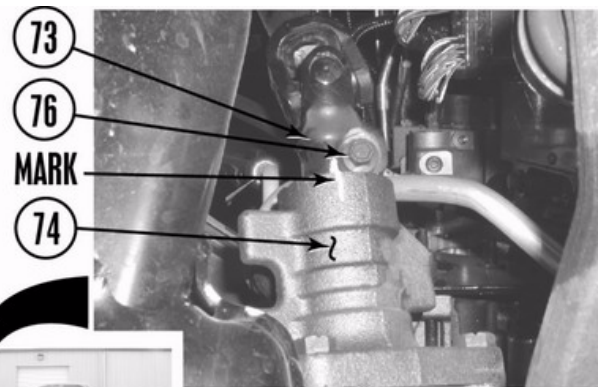
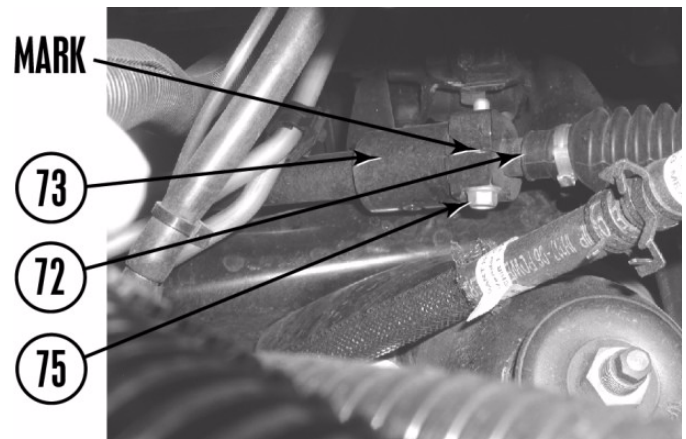

9. Along the frame rails/under driver side cab.

- a. Remove bolt/captive washer (77) and ground strap (78) from frame (16) driver side wheel well.
- b. Remove clip (79) and harness (80) from frame (16) driver side.

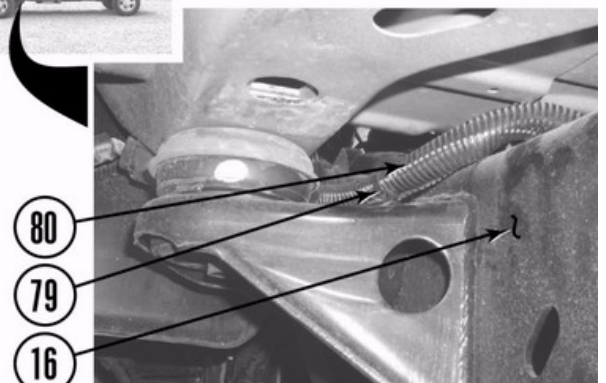

c. Remove clip (81) and wire harness (80) from inside frame (16) driver side.

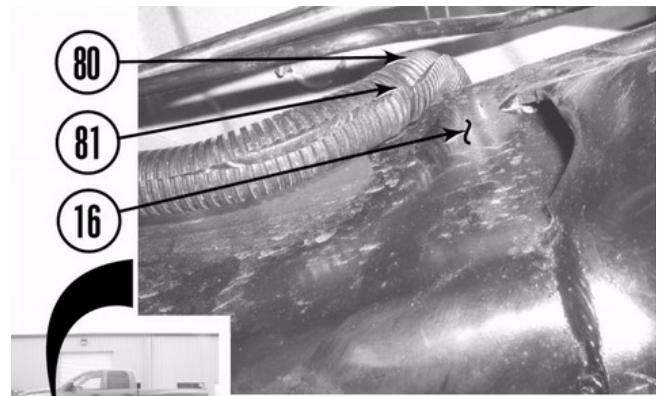

d. Remove push clip clamp (82) and automatic transmission cable (83) from frame (16) driver side.

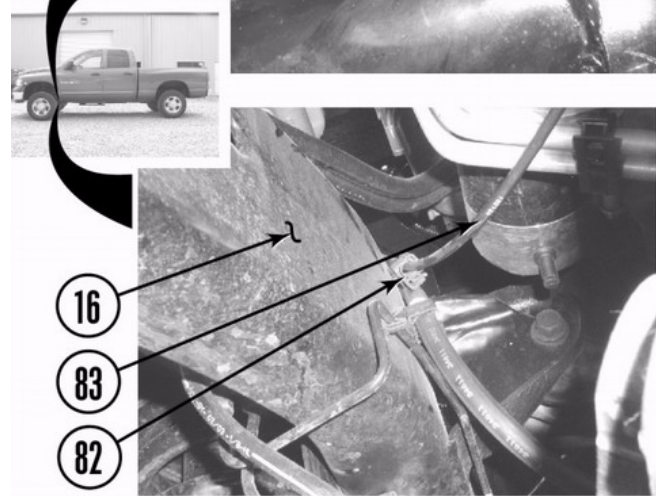

e. If equipped, remove two clips (84) from driver side and passenger side wheel wells (85 and 86).

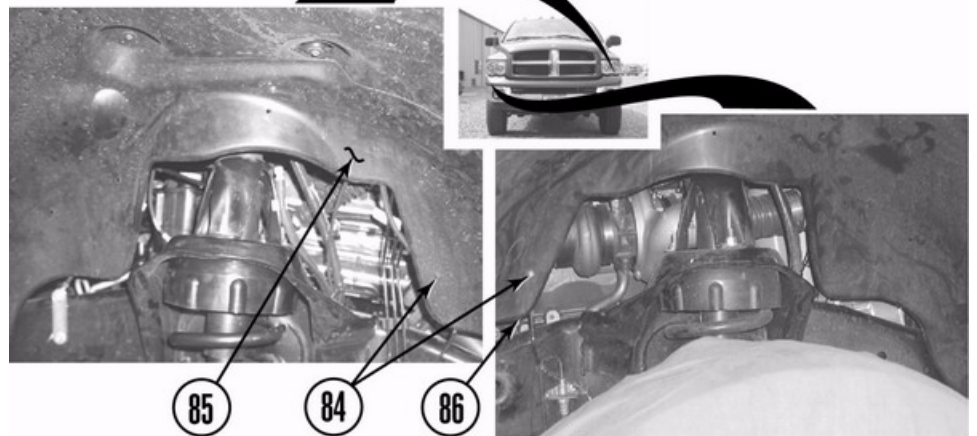

f. Apply the parking brake. Clamp two rear cables (88) at driver side rear frame mount (16) with a pair of vice grips (87). Release the parking brake.

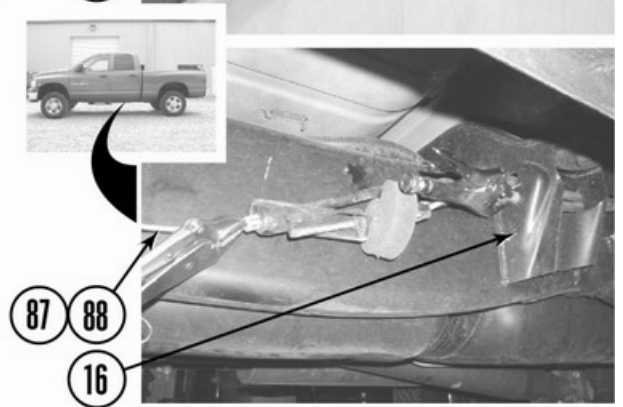

- g. Separate front parking brake cable (87) from rear parking brake cables (88).
- h. Remove front parking brake cable (87) from driver side frame mount (89).

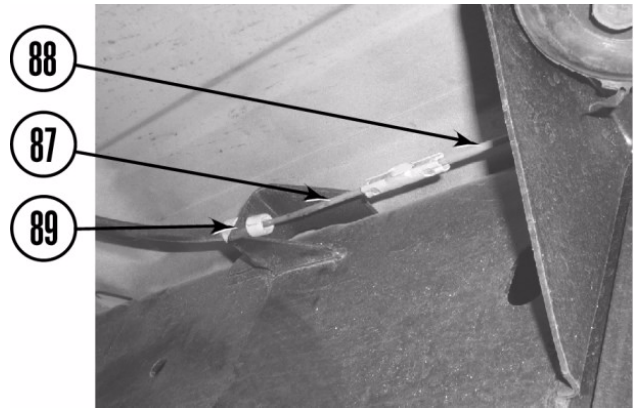

10. Along the frame rails/under passenger side cab.

- a. Remove two push clips (90) and block heater cord (91) from frame (16) passenger side.

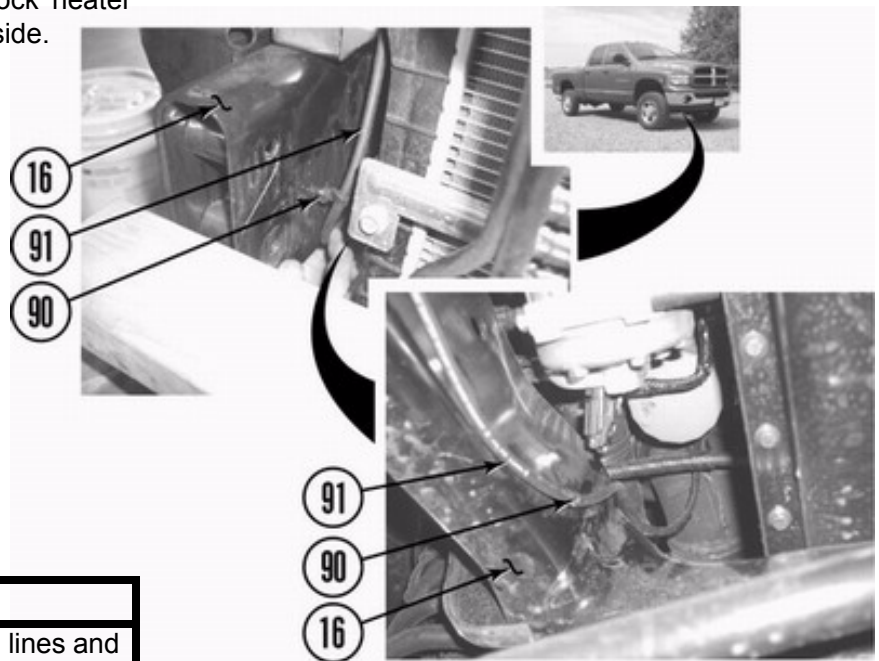

⚠WARNING
 Use extreme caution when working near fuel lines and fuel tank. Clean up spilled fuel immediately. Any spark could cause an explosion or fire resulting in serious personal injury and property damage.

11. Remove the fuel filler from bed.

- a. Remove gas cap (92) from fuel filler assembly (93).
- b. Remove three bolts (94) from bed (95) and fuel filler assembly (93).

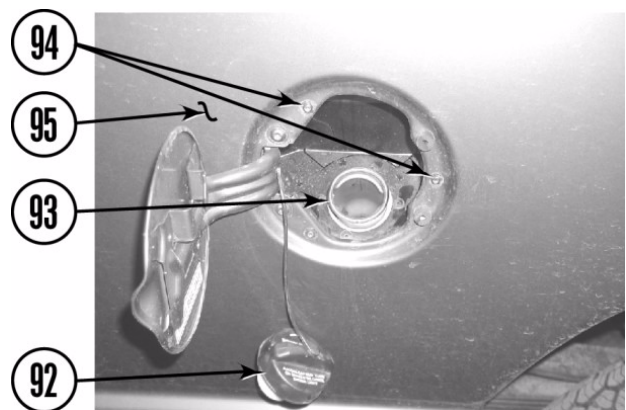

12. Remove the rear bumper.

- a. Measure distance between rear bumper (96) and tailgate (97).
- b. If so equipped, remove two clips (98) and harnesses (99) from two rear bumper brackets (100).
- c. Disconnect two connectors (101) from license plate lights (102).

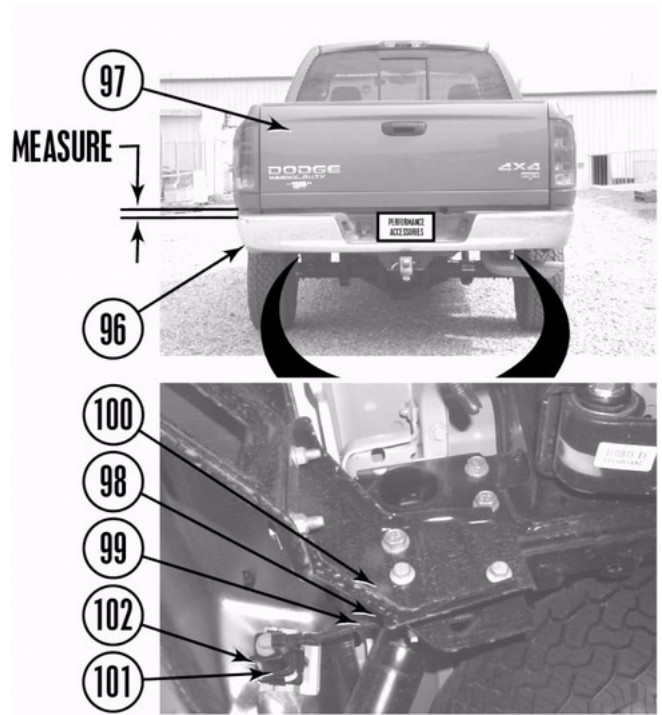

- d. Slide red locking tab (103) from locked position on hitch electrical connector (104). Press tab and disconnect hitch electrical connector from rear bumper connector (105).

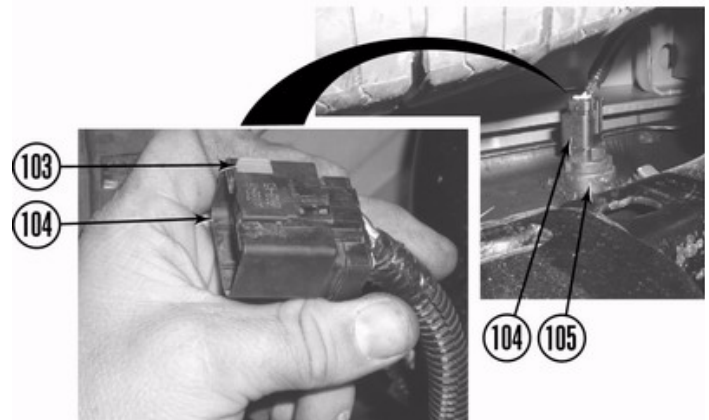

- e. Remove four screws (106) and license plate (107) from rear bumper (96).

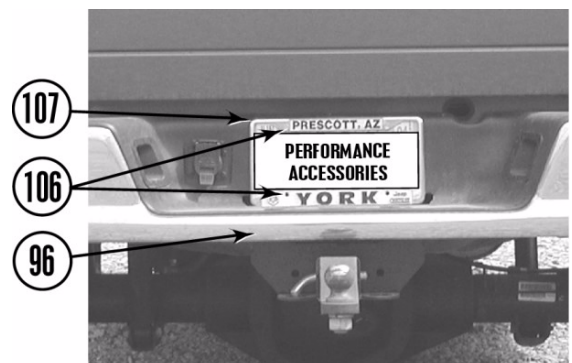

- f. If equipped with a trailer hitch (108), remove two bolts (109) from rear bumper (96) and trailer hitch.

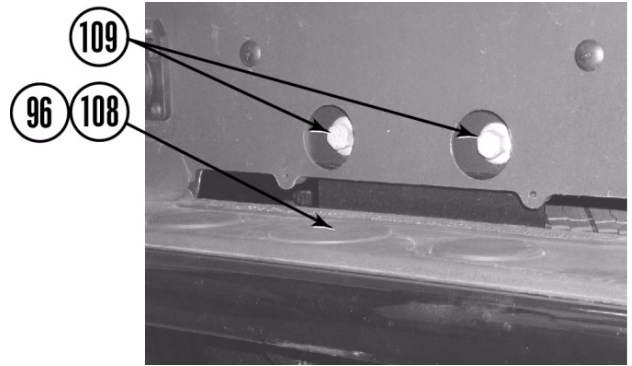

- g. Remove two bolts (110) from rear bumper (96) and frame (16).

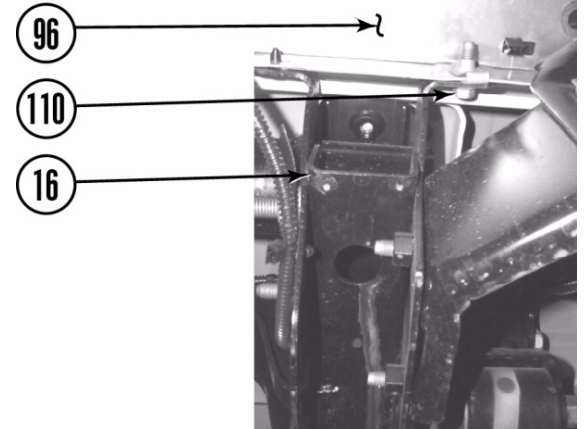

- h. Remove six bolts (111 and 112) from two rear bumper brackets (100) and frame (16). Remove rear bumper (96) from frame.

- i. Remove two nuts (113), double bolt fasteners (114), and rear bumper brackets (100) from rear bumper (96).

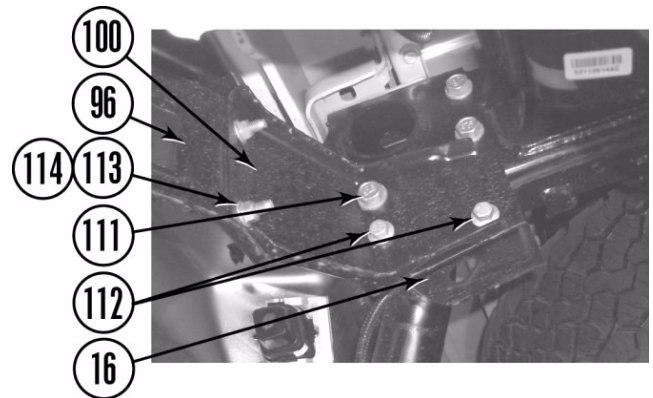

13. Spare tire.

- a. Lower spare tire to the ground (see owner's manual).
- b. Remove clip (115) and ratchet tube (116) from spare tire crank mechanism (117).
- c. Remove two bolts (118) and spare tire crank mechanism (117) from crossmember (119).

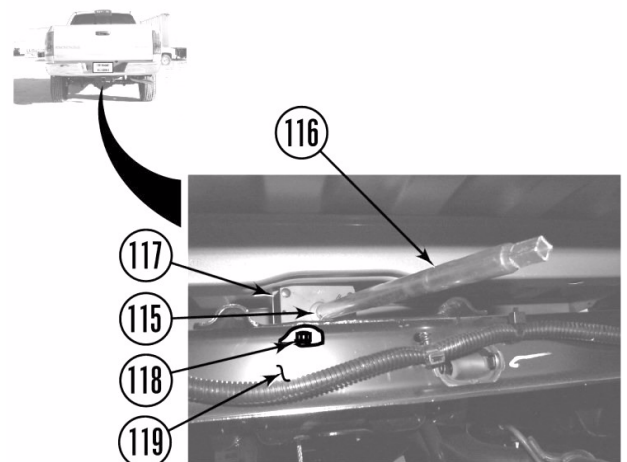

14. **Manual transmission:** Remove shift lever.

- a. Shift manual transmission shift lever (120) into neutral.
- b. Remove four screws (121) from boot (122) and console (123) and slide boot up on shift lever (120).
- c. Unscrew shift lever (120) from shift tower lever (124). DO NOT remove the shift tower (125); it is shown removed only for clarity.
- d. Remove rubber cover (126) from shift tower (125).
- e. Remove four screws (127), plate (128), and shim(s) (129) from shift tower (125).
- f. Remove shift tower lever (124) from shift tower (125).
- g. Remove two plastic shift tabs (130) and plastic ball end locator (131) from shift tower lever (124).

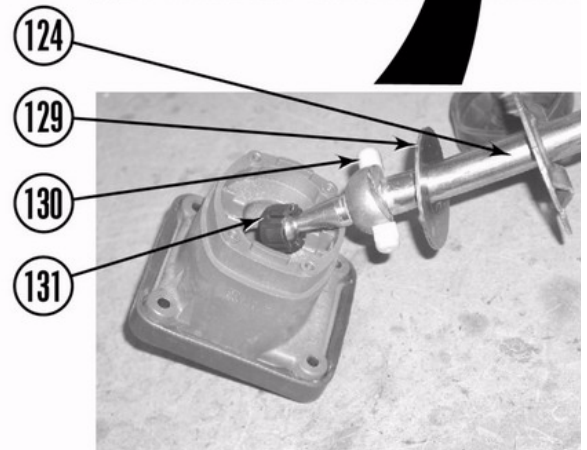
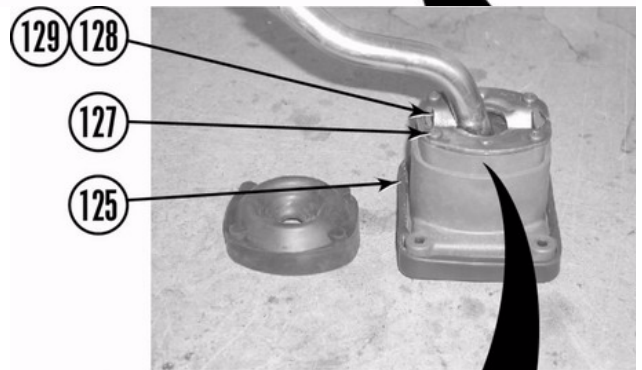
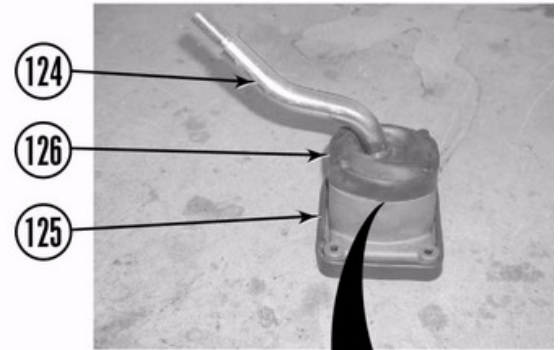
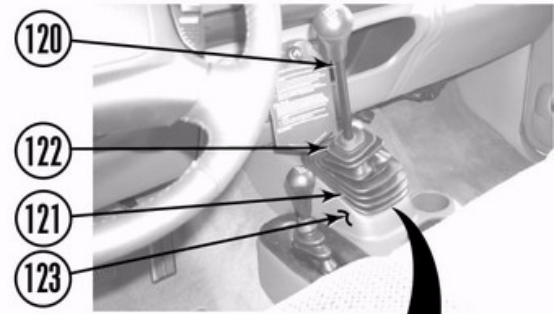

⚠WARNING

A certified welder should perform all welding.

15. Manual transmission: Lengthen shift lever.

- a. Scribe a line along the side of the shift tower lever (124) (below the lowest bend) as shown. Cut the lever into two pieces through the line and deburr as necessary.
- b. Position *kit* shift lever extension (132) between the two pieces of the shift tower lever (124). Ensure the extension and lever scribed lines align and weld the extension in place.

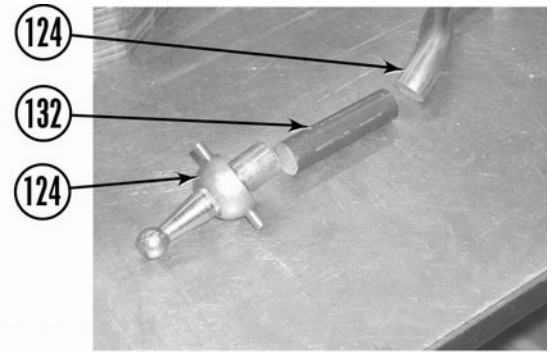

16. Manual transmission: Install shift lever.

- a. Install two plastic shift tabs (130), plastic ball end locator (131), shim(s) (129), and plate (128) on shift tower lever (124).
- b. Install shift tower lever (124) on shift tower (125) with four screws (127).
- c. Install rubber cover (126) on shift tower lever (124) and shift tower (125).
- d. Install transmission shift lever (120) on shift tower lever (124).

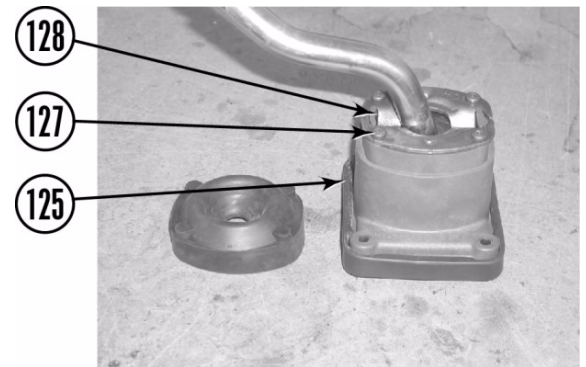
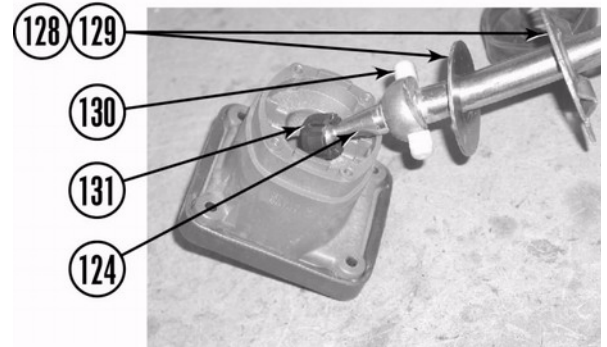

- e. Install boot (122) on console (123) with four screws (121).
- f. Check transmission shift lever operation. Ensure there is complete engagement in all gears.

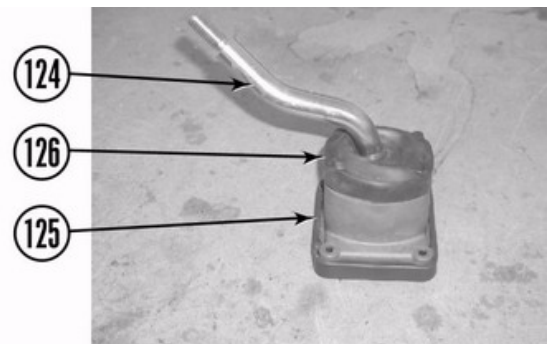
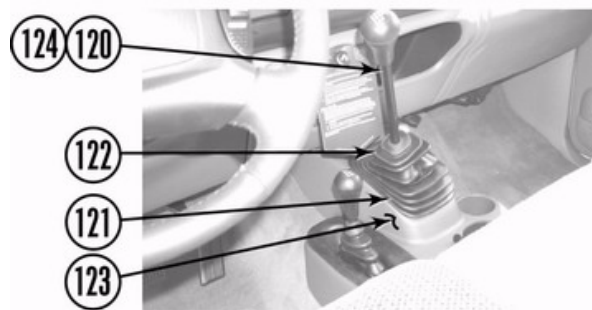

17. **Manual-shift 4WD:** Remove shift linkage rod

- a. Move 4WD shift lever (133) into 2H position.
- b. Remove trunnion (134) and shift linkage rod (135) from 4WD shift lever (133) and transfer case input lever (136).

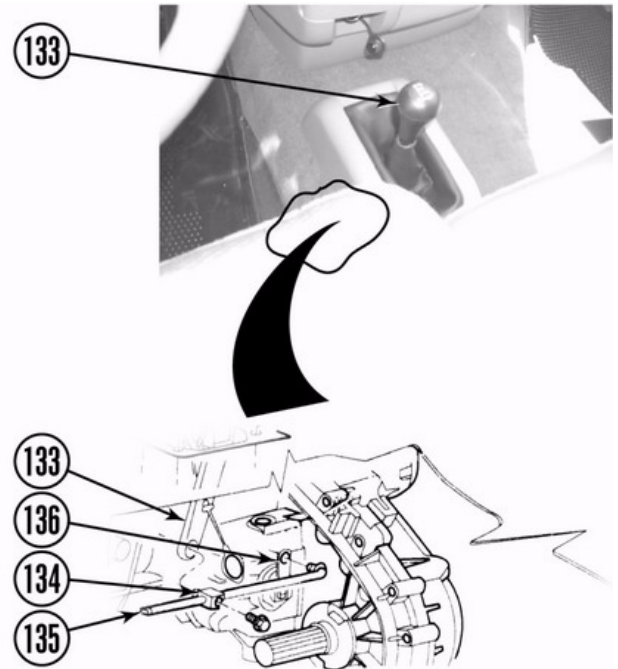

18. **Manual-shift 4WD:** Adjust shift linkage.

NOTE

It might be best to wait until after the cab has been lifted before adjusting the shift linkage.

- a. Loosen bolt (137) from trunnion (134). Move trunnion approximately 1/4" to 1/2" toward the end of the shift linkage rod (135). Tighten bolt.

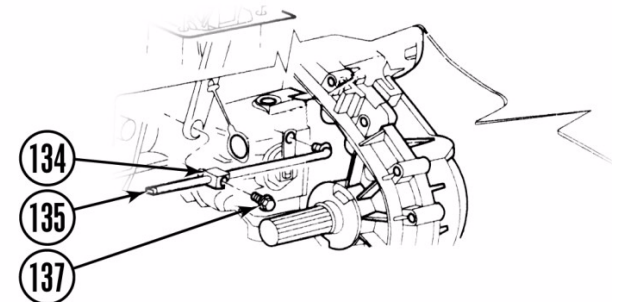

- b. Install shift linkage rod (135) in transfer case input lever (136).
- c. Install trunnion (134) in 4WD shift lever (133).
- d. Check operation of 4WD shift lever (133). Ensure there is complete engagement in all ranges. It may be necessary to adjust position of trunnion on shaft to achieve this.

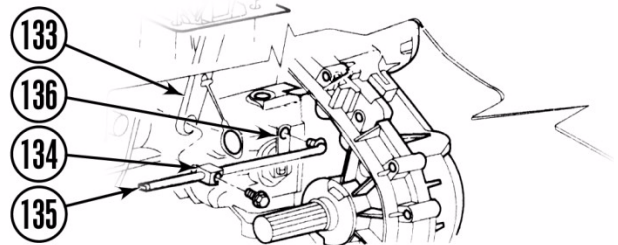

C. Install the kit.

1. Prepare to lift cab from frame.

⚠ WARNING

The kit **blocks** must be installed in addition to the factory upper and lower bushings. Installing the kit **blocks** without the factory upper and lower bushings could result in damage to the vehicle or serious personal injury.

- a. Measure distance between cab (138) and bed (95). Record measurement for later reference.
- b. Loosen but do not remove two core support bolts (139) from core support mounting pads (140).
- c. Loosen but do not remove six (four on a single cab) cab mounting bolts (141).

⚠ WARNING

Use extreme caution when lifting cab from frame. Ensure lifting device is securely placed. Keep hands out from between frame and cab, or serious personal injury could result.

⚠ CAUTION

Continually check hoses, wires, lines, etc. to be sure that everything is flexing properly and not binding, or damage to the vehicle could result. Be especially careful of the a/c hoses at the firewall, the belt pulley, and at the core support. Ensure brake lines stretch while lifting. Bending the lines to gain ample slack may be necessary. Be extremely careful not to kink the lines.

- d. Remove core support bolt (139) and bottom bushing (142) from passenger side core support (20) and passenger side core support mounting pad (140).
- e. Remove three bolts (141) and bottom bushings (142) from the passenger side frame mounting pads (89) and cab (138).

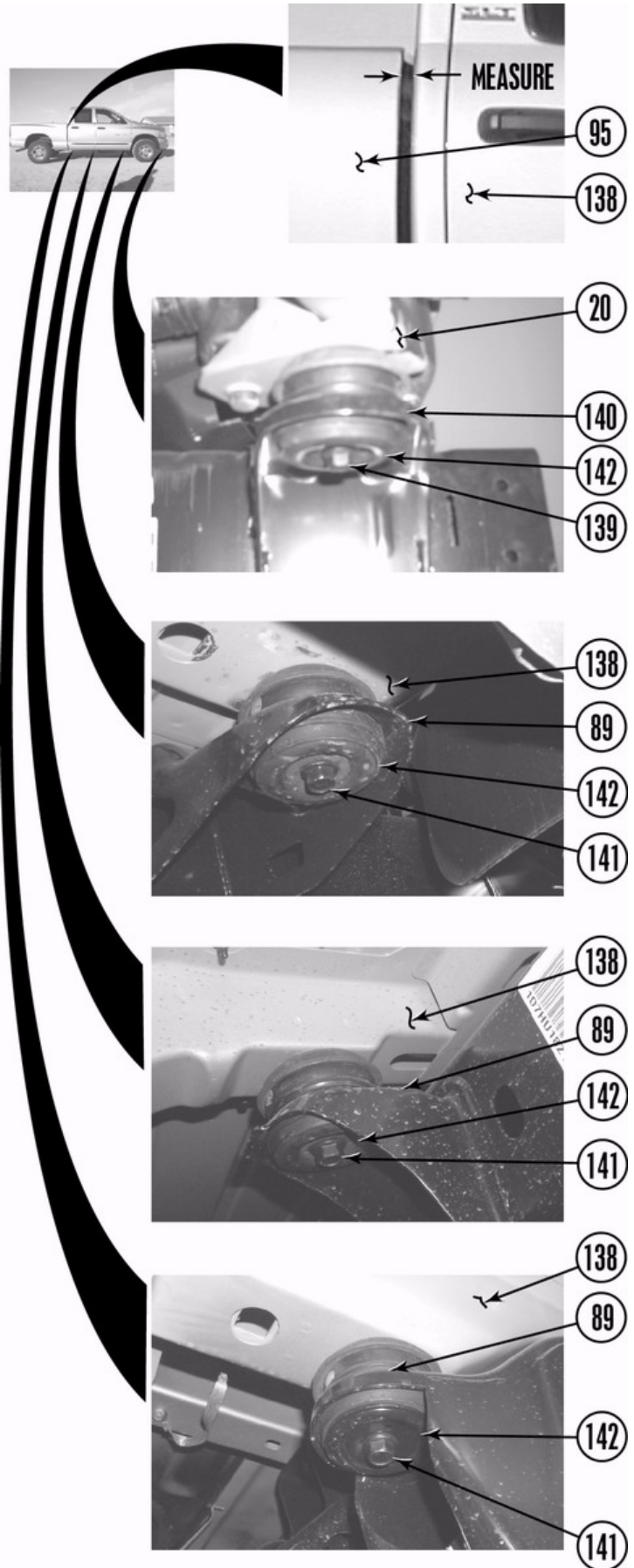

2. Install *kit* lift blocks on passenger side of cab.

- a. Using a hydraulic jack and a wooden block, slowly lift the cab (138) passenger side just high enough to position a *kit* lift block (143) between the metal cup (144) and the passenger side core support (20).
- b. Position three *kit* lift blocks (143) on top of the metal cups (144), upper bushings (145), and passenger side frame mounting pads (89).
- c. Install a *kit* 12mm x 180mm bolt (146) through *kit* 7/16" USS washer (147), bottom bushing (142), core support mounting pad (140), upper bushing (145), metal cup (144), *kit* lift block (143), and cab passenger side core support (20). Do not tighten.
- d. Install three *kit* 12mm x 180mm bolts (146) through three *kit* 7/16" USS washers (147), bottom bushings (142), frame mounting pads (89), upper bushings (145), metal cups (144), *kit* lift blocks (143), and cab (138). Do not tighten.
- e. Lower cab (138) on the *kit* lift blocks (143).

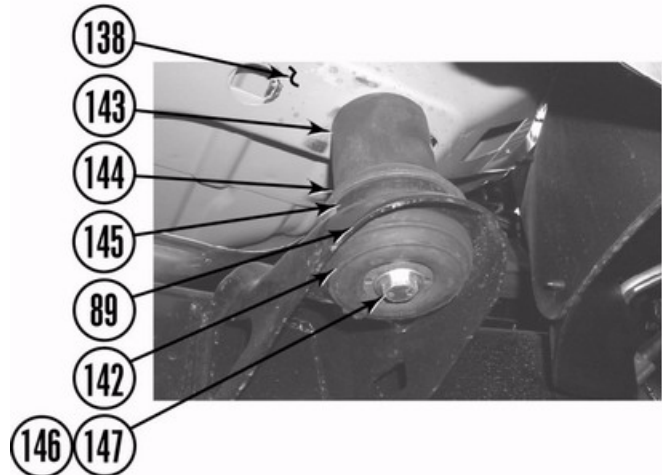
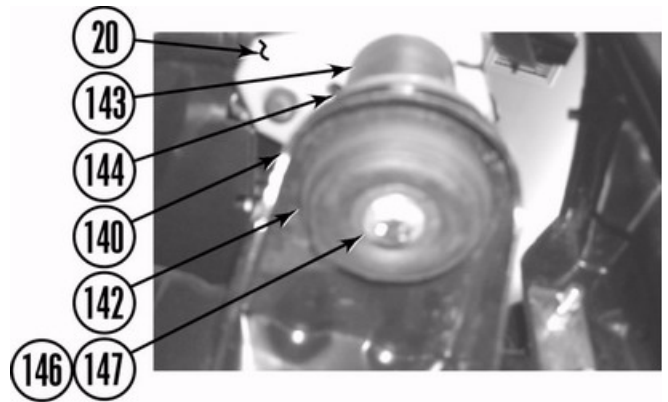

3. Install *kit* lift blocks on driver side of cab.

- a. Repeat previous steps to install *kit* lift blocks on driver side of cab.

4. Finish installing *kit* lift blocks on cab.

- a. Remove eight bolts (146) one at a time, coat threads with Loctite® and reinstall. Check cab (138) alignment to bed (95) and tighten to 55 lb-ft.

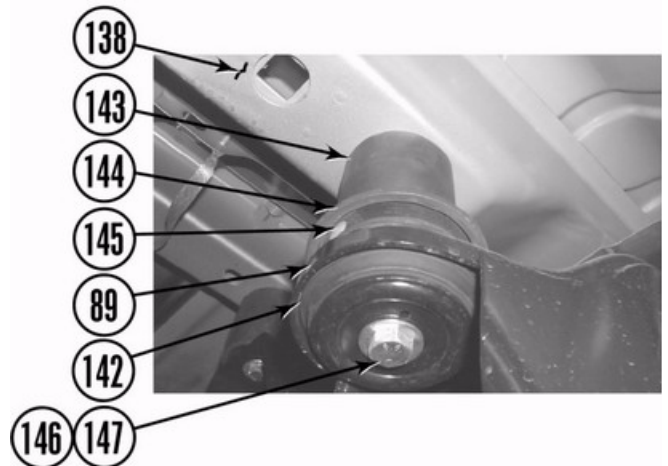
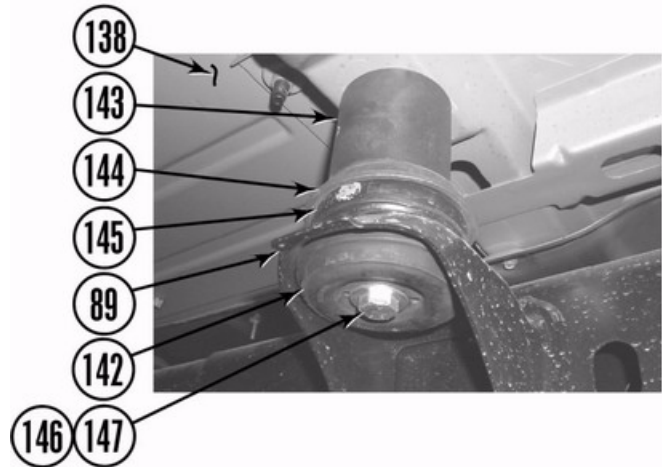

- b. Reposition *kit* bed crush blocks (30) under radiator (27). Ensure fan to fan shroud clearance is maintained. Let radiator rest on *kit* bed crush blocks (30) as shown.

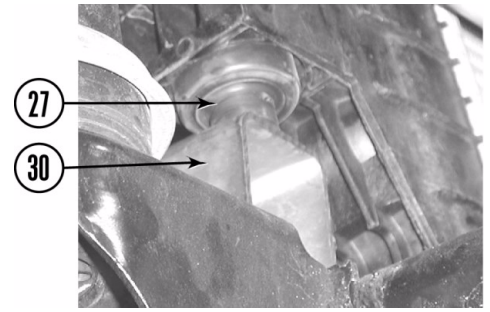

- 5. Install *kit* lift blocks on passenger side of bed.

- a. Loosen, but do not remove, six (eight on a long bed) bed mounting bolts (148) from frame mounting pads (89) and bed (95).
- b. Remove three bed mounting bolts (148) from frame mounting pads (89) and bed (95) passenger's side.

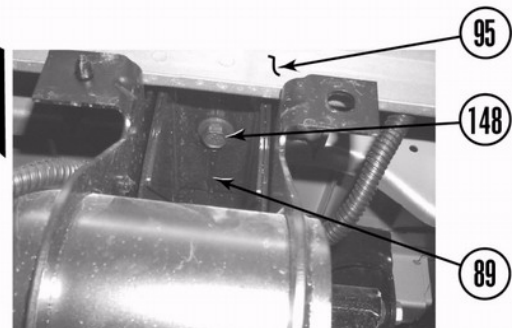
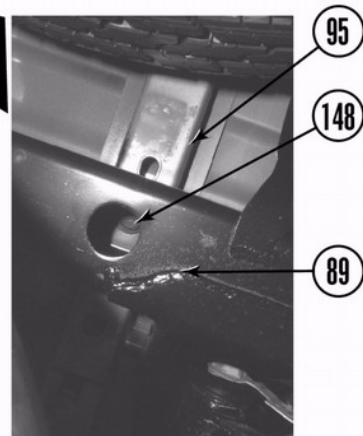
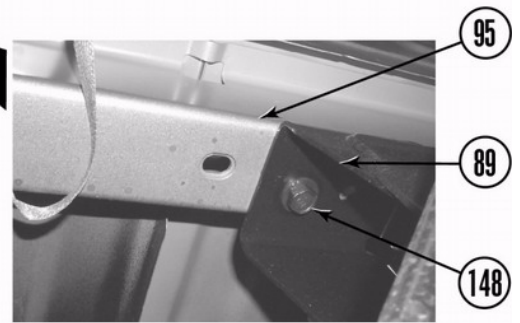

- c. Using a hydraulic jack and a wooden block, slowly lift the bed (95) passenger's side just high enough to position three *kit* lift blocks (143) on frame mounting pads (89).
- d. Install two *kit* 12mm x 100mm bolts (149) through two *kit* 7/16" USS washers (147), frame mounting pads (89), *kit* lift blocks (143), and bed (95). Do not tighten.

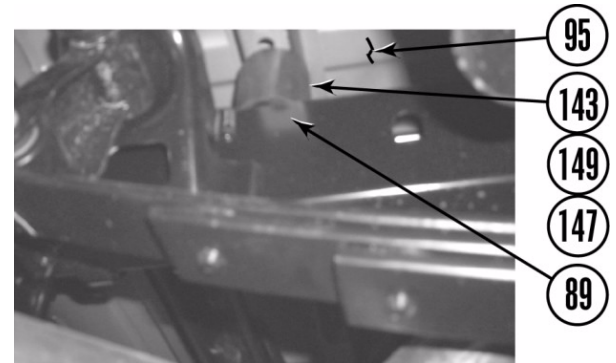
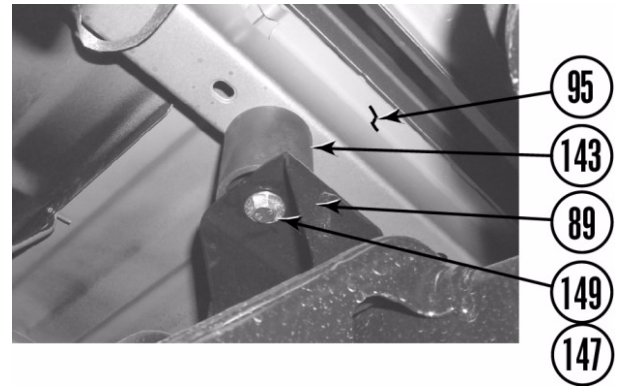

- e. Install *kit* 12mm x 120mm bolt (150) through *kit* 7/16" USS washer (147), frame mounting pads (89), *kit* lift blocks (143), and bed (95). Do not tighten.

- f. Lower the bed (95) onto the *kit* lift blocks (143).

6. Install *kit* lift blocks on driver side of bed.

- a. Repeat previous steps to install *kit* lift blocks on driver side of bed.

7. Finish installing the *kit* lift blocks.

- a. Adjust the cab to bed clearance using the measurements recorded earlier.

- b. Remove six bed mounting bolts (149 and 150) one at a time, coat threads with Loctite®, and reinstall. Tighten to 55 lb-ft.

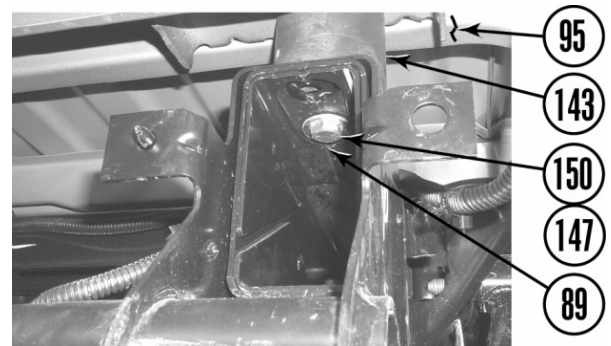

⚠WARNING

Use extreme caution when working near fuel lines and fuel tank. Clean up spilled fuel immediately. Any spark could cause an explosion or fire resulting in serious personal injury and property damage.

8. Install fuel filler.

- a. Remove two clamps (151 and 152), fuel filler assembly (93) from gas tank (153) and vehicle.
- b. Carefully cut fuel filler hose (154) and vent hose (155) where shown.
- c. Install *kit* fuel filler extension (156) on filler hose (154) with two *kit* #36 hose clamps (157).
- d. Install *kit* fuel filler vent extension (158) on vent hose (155) with two *kit* #10 hose clamps (54).

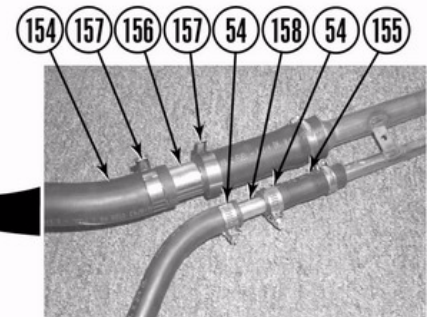
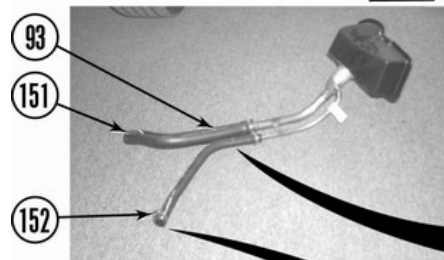
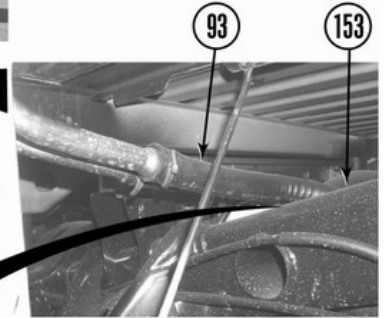

- e. Install fuel filler assembly (93) on gas tank (153) with two clamps (151 and 152).

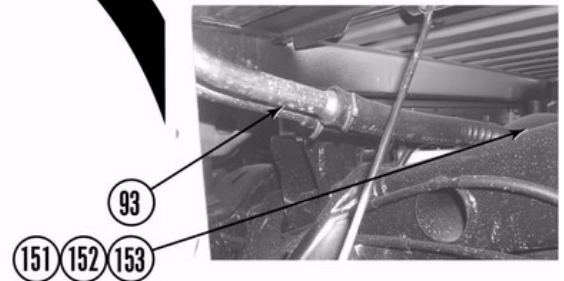

- f. Install fuel filler assembly (93) on bed (95) with three bolts (94).
- g. Install gas cap (92).

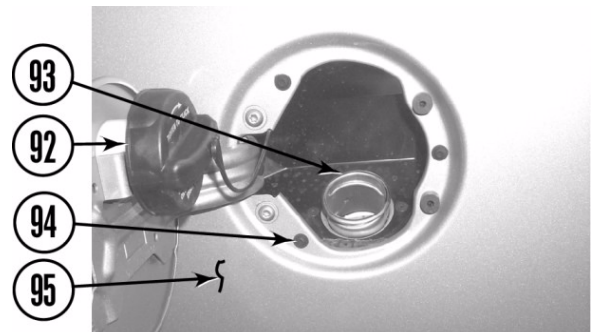

9. Along the frame rails/under passenger side cab.

- a. Install block heater, cord (91) on frame (16) with two push clips (90). If necessary adjust position of push clips on block heater cord to go in original frame holes.

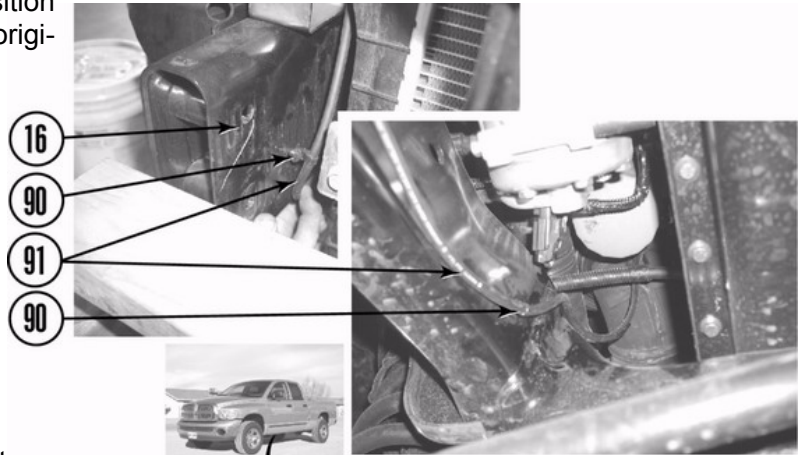

10. Along the frame rails/under driver side cab.

- a. Using *kit* parking brake bracket (159) as a template, mark and drill a 5/16" hole in the bottom of the driver side frame mount (89).
- b. Route front parking brake cable (87) over driver side frame mount (89) and through biggest hole in *kit* parking brake bracket (159) and reconnect front cable to rear cables (88).
- c. Install *kit* parking brake bracket (159) on driver side frame mount (89) with *kit* 5/16" x 1" bolt (160), two *kit* 5/16" USS washers (161), *kit* 5/16" nylock nut (162), *kit* 7/16" x 1" bolt (163), two *kit* 7/16" USS washers (147), and *kit* 7/16" nylock nut (164).

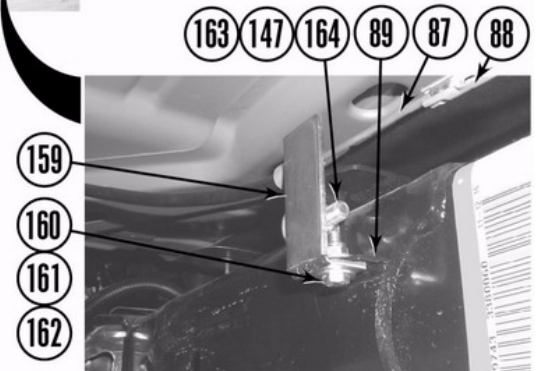

- d. Release pair of vice grips from rear parking brake cables (88).

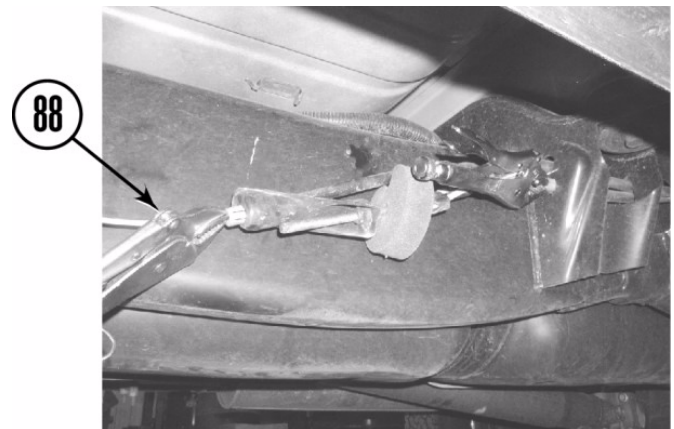

e. Using a *kit* zip tie (29), secure automatic transmission cable (83) to two fuel lines (165) that are clad with rubber hose.

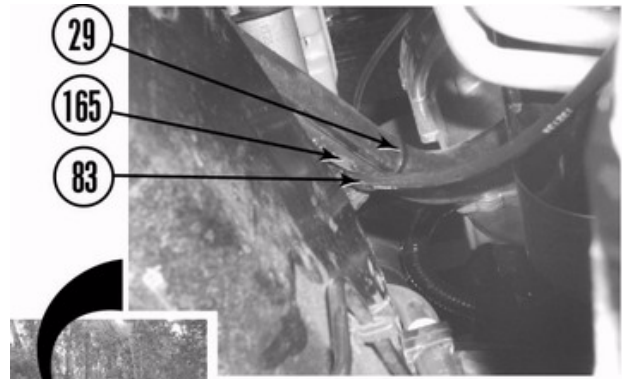

f. If possible, install clip (81) with harness (80), on frame (16) driver side.

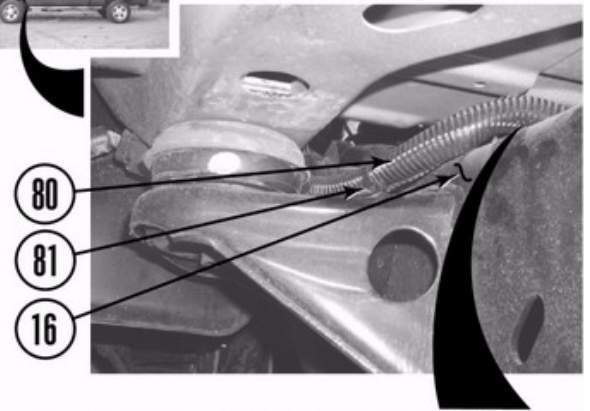

g. If possible, install clip (79) and harness (80) on frame (16).

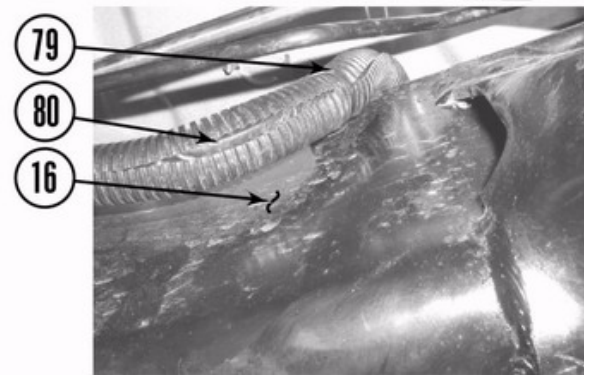

h. Install ground strap (66) on stud (67) and firewall (68) with nut (65).

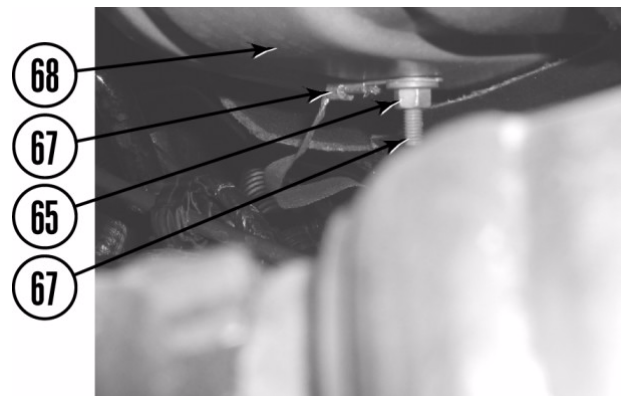

- i. Install ground strap (78) on *kit* ground strap extension bracket (166) with *kit* 1/4" x 1" bolt (167), two *kit* 1/4" SAE washers (168), and *kit* 1/4" nylock nut (169).
- j. Install *kit* ground strap extension bracket (166) on frame (16) driver side with bolt/captive washer (77).

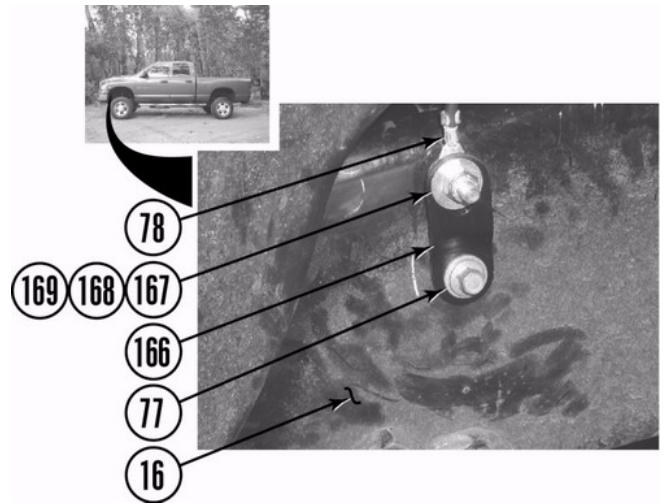

11. Connect steering and install *kit* steering extension.

- a. Coat threads of retaining bolts (170, 75, and 76) with Loctite®.
- b. Install *kit* steering extension (171) on upper steering shaft (72) with *kit* 3/8" x 1 1/4" socket head bolt (170). Do not tighten.
- c. Install lower steering shaft (73) on *kit* steering extension (171) with the stock retaining bolt (75).

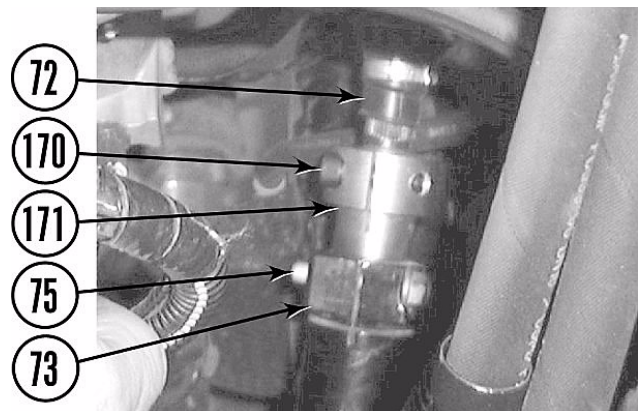

- d. If removed, install lower steering shaft (73) on gear box (74) with bolt (76). Ensure all marks are aligned.
- e. Tighten bolts (170, 75, and 76) to 33 lb-ft.

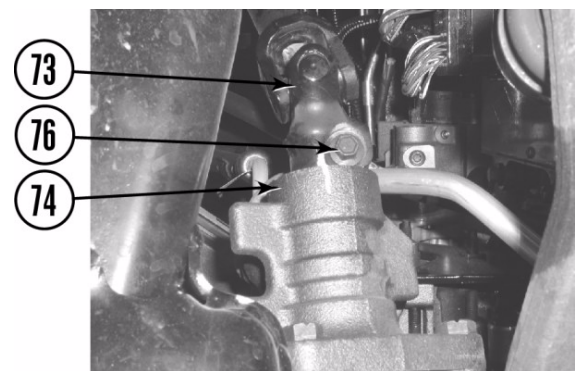

- f. Install *kit* zip tie (29) on bracket (71) and wiring harness (70).

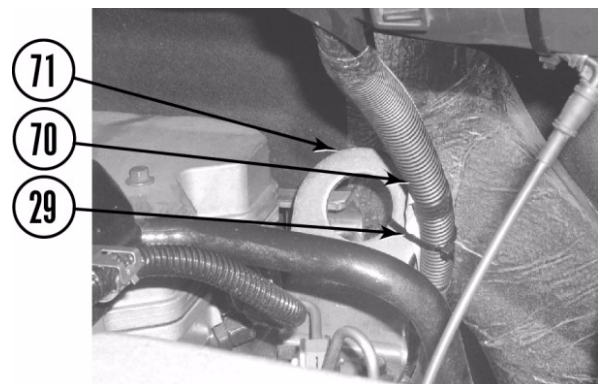

12. Battery cables (engine connection passenger side).

- a. Remove bolt/captive washer (183) and negative battery cable (1) from engine (184) passenger side.
- b. Install negative battery cable on engine (184) (above original location) with bolt/captive washer (183).

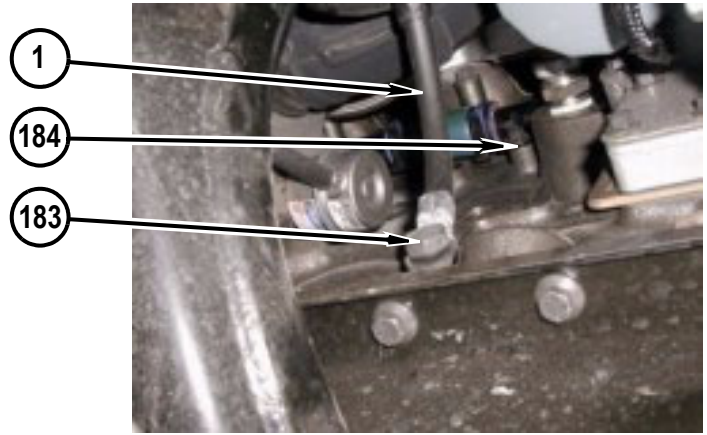

- c. Remove nut (186) and two wire connectors (187) from positive battery cable end (2) passenger side.

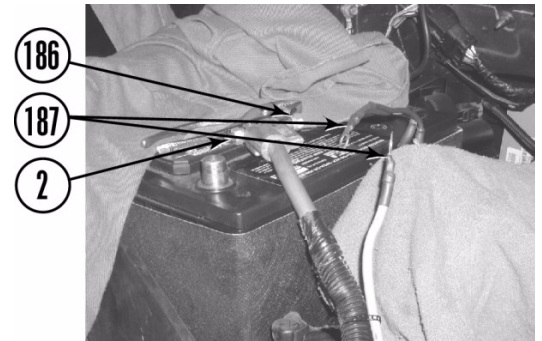

- d. If necessary, at the passenger side battery, install *kit* positive cable extension bracket (188) on positive battery cable end (2) with nut (186).
- e. Install two wire connectors (187) on *kit* positive cable extension bracket (188) with *kit* 1/4" x 3/4" bolt (179), two *kit* 1/4" SAE washers (168), and *kit* 1/4" nylock nut (169). Do not connect battery cables to the battery.

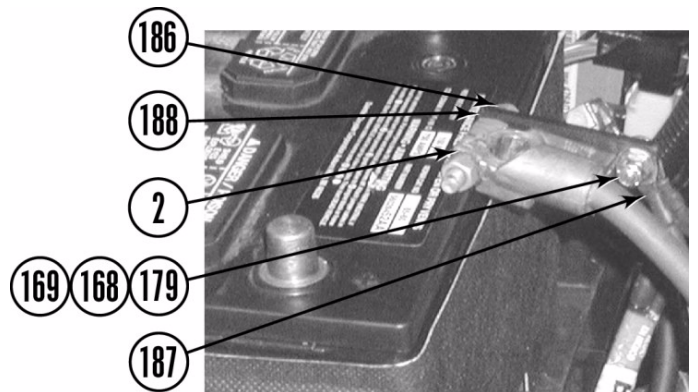

13. Battery cable (engine connection driver side).

- a. Remove bolt/captive washer (183) and negative battery cable (1) from engine (184) driver side.
- b. Install *kit* negative cable extension bracket (185) on engine (184) with bolt/captive washer (183).
- c. Install negative battery cable (1) on *kit* negative cable extension bracket (185) with *kit* 7/16" x 1" bolt (163), two *kit* 7/16" USS washers (147), and *kit* 7/16" nylock nut (164).

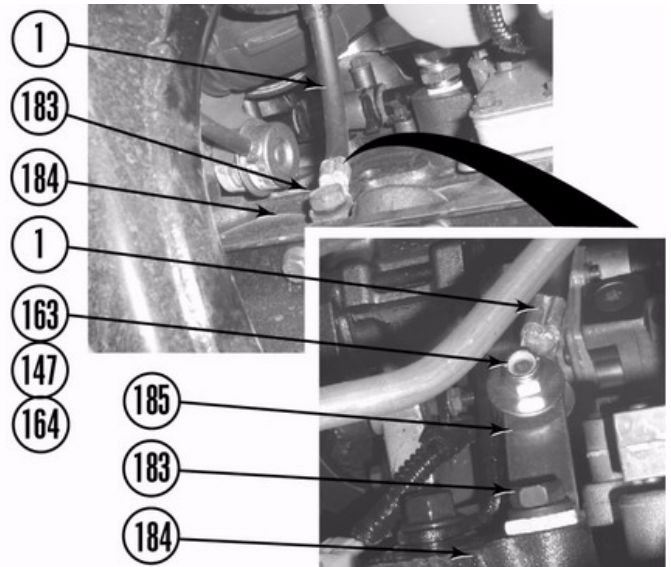

- d. Remove nut (186) and positive battery crossover cable (189) from positive battery cable (2). Do not connect positive battery cable to battery.



- e. Remove wire harness connector (190) from white clip (191) and wiring harness (192).

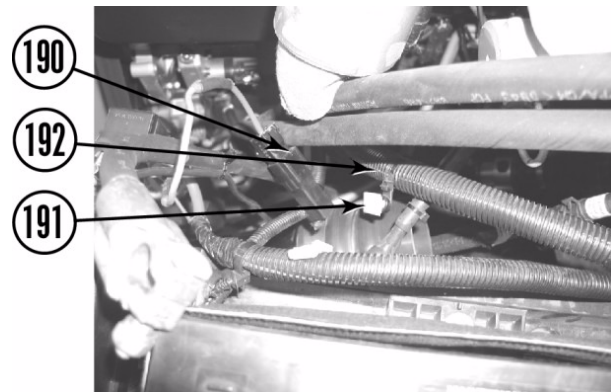

- f. Remove two dust covers (193), nut (194), and battery cable (195) from fuse box (196).

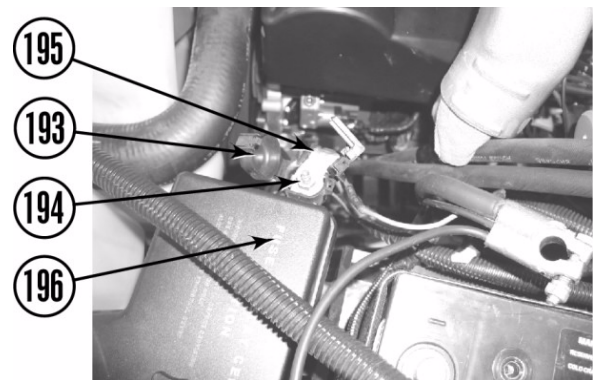

- g. Disconnect wire harness connector (197) and wire (198).

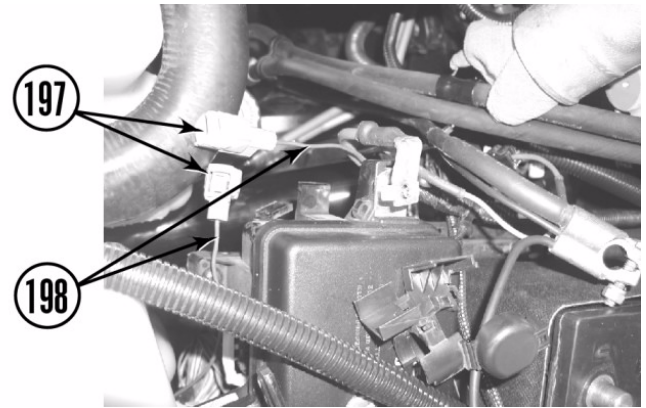

- h. Reposition battery cables (2 and 195) and wiring harness connectors (190 and 197) from under transmission cooler lines (36) to just behind transmission cooler lines as shown.

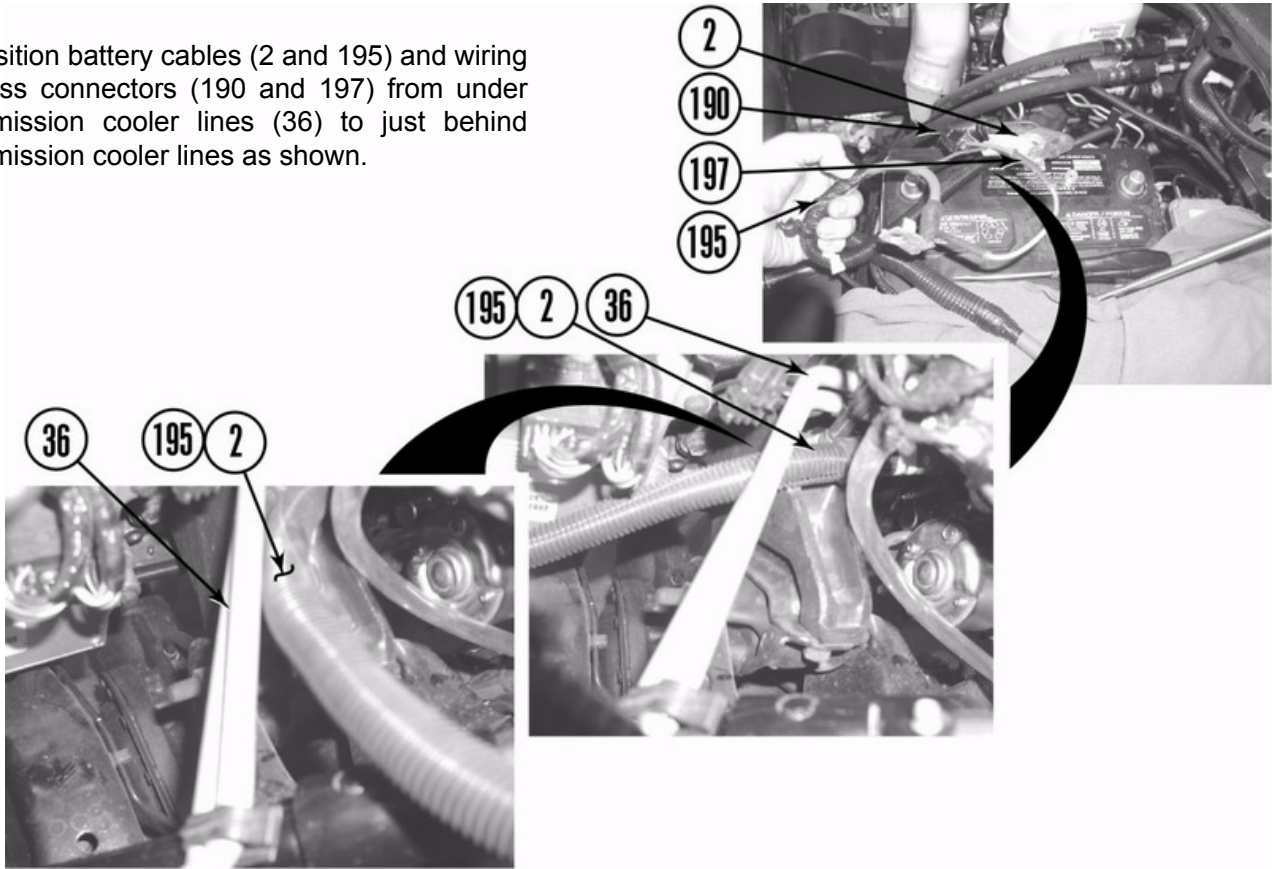

- i. Connect wire harness connector (197) and wire (198).

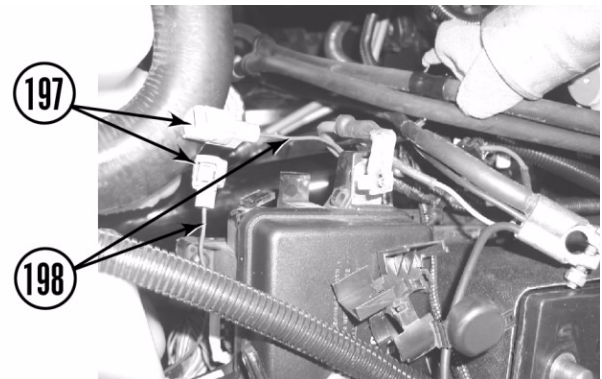

- j. Install battery cable (195) and dust covers (193) on fuse box (196) with nut (194).
- k. Install wire harness connector (190) on white clip (191) and wiring harness (192).

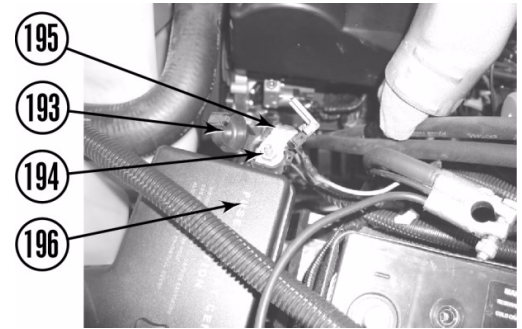

- l. Install positive battery crossover cable (189) on positive battery cable (2) with nut (186). Do not connect battery cables to the battery.

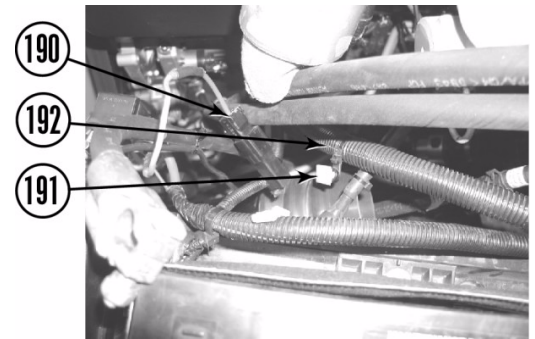

14. Install radiator.

- a. Remove *kit* bed crush block (30) from frame (16) and radiator (27) support on driver side. Ensure that fan does not come in contact with radiator or fan shroud.
- b. Install *kit* lower radiator bracket (172) on driver side of core support (20) with four bolt/captive washers (31).
- c. Position radiator (27) on *kit* lower radiator bracket (172).
- d. Repeat previous three steps on passenger side.



NOTE
Some vehicles require the use of *kit* 6mm fasteners (bolts and nuts) and *kit* 1/4" SAE washers.

- e. Apply Loctite® to threads of two *kit* 8mm x 30mm bolts (174).
- f. Install two *kit* upper radiator brackets (175) on core support (20) with two *kit* 8mm washers (176) and two *kit* 8mm x 30mm bolts (174).
- g. Install radiator (27) and two bushings (34) on two *kit* upper radiator brackets (175) with two bolt/captive washers (33), *kit* 8mm washers (176), and *kit* 8mm nylock nuts (177).

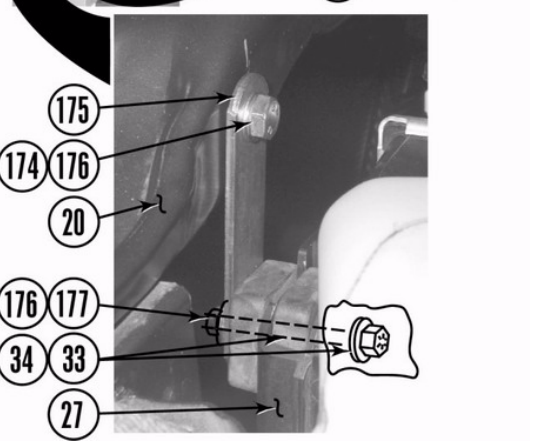
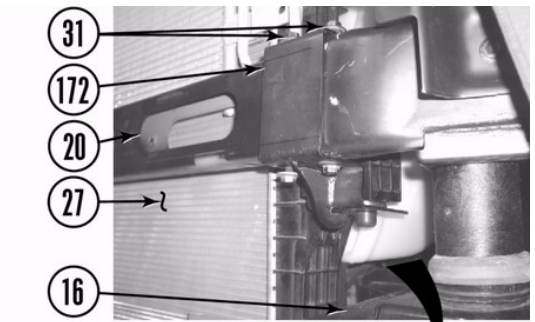

15. Install transmission cooler.

- a. Cut two transmission cooler locking tabs (28) from lower radiator (27) as shown.
- b. Install two *kit* transmission cooler brackets (178) on radiator (27) with two bolt/captive washers (25). Ensure *kit* transmission cooler brackets (178) are locked into place as shown.
- c. Install transmission cooler (26) on *kit* transmission cooler brackets (178) with four *kit* 1/4" x 3/4" bolts (179), eight *kit* 1/4" SAE washers (168), and four *kit* 1/4" nylock nuts (169).

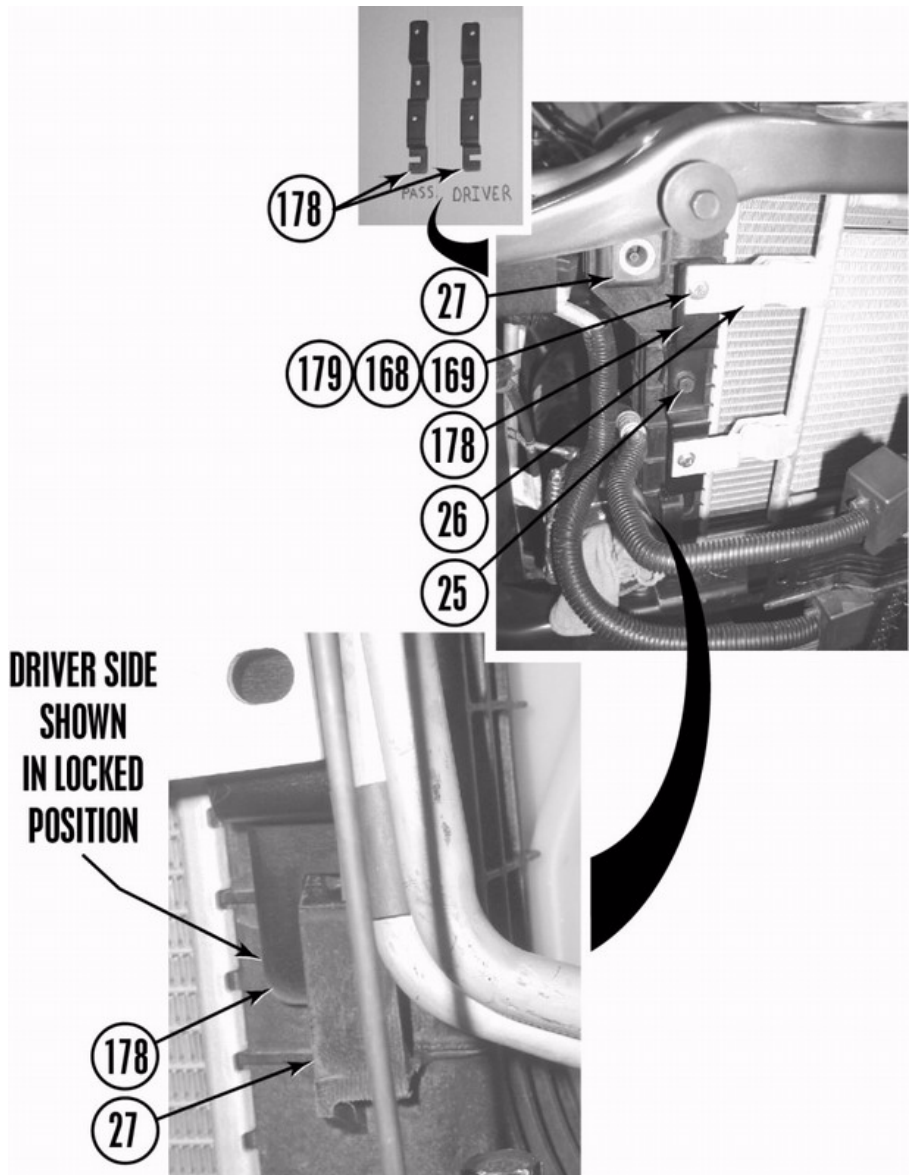
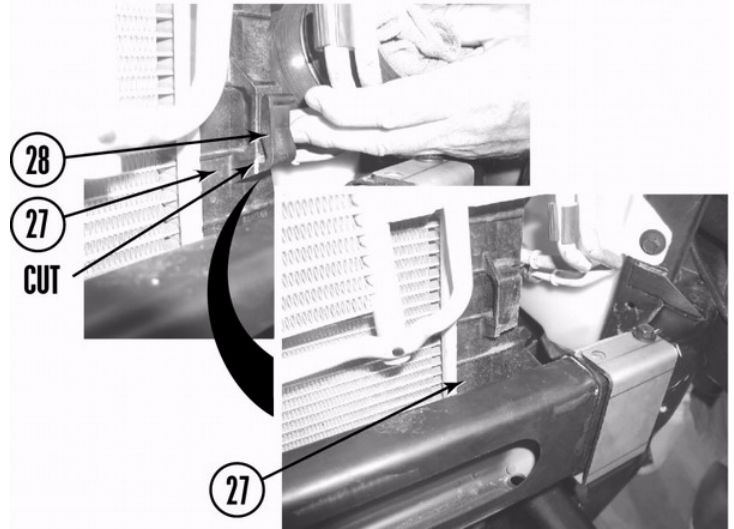

16. Install intercooler.

- a. Position intercooler (19) on core support (20).

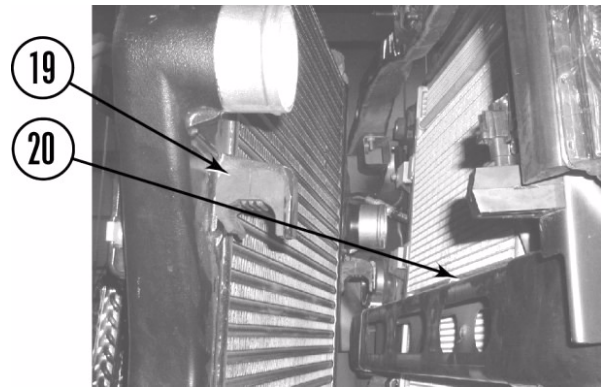

- b. Install intercooler (19) and two upper bushings (18) on core support (20) with two bolt/captive washers (17).

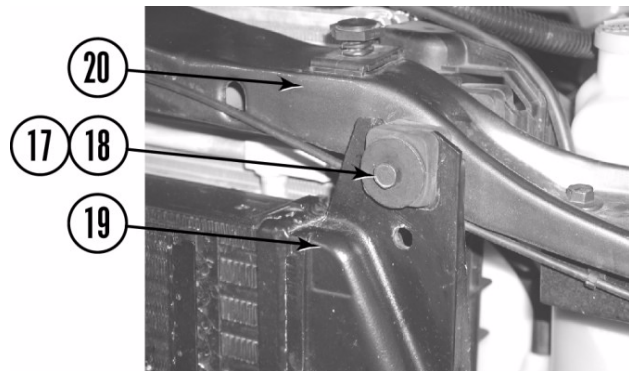

- c. Install air duct (64) and flex connector (24) on intercooler (19) with clamp (23) passenger side. If necessary loosen clamp at turbo and slightly rotate air duct clockwise for a better fit. Tighten two clamps on the intercooler and the turbo.

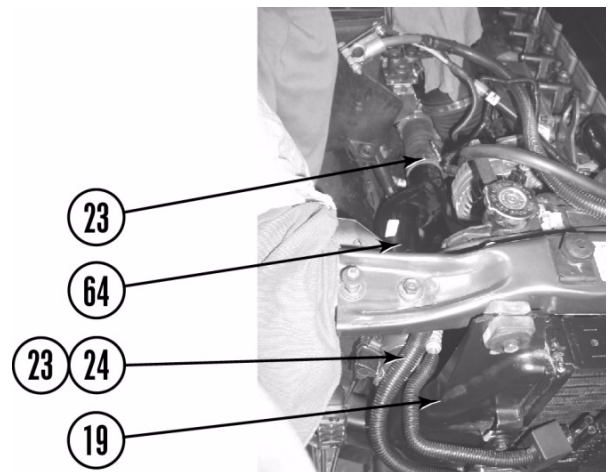

17. Install AC condenser and AC lines.

- a. Install four *kit* A/C condenser brackets (180) on AC condenser (22) with four *kit* 1/4" x 3/4" bolts (179), eight 1/4" SAE washers (168), and four *kit* 1/4" nylock nuts (169).
- b. Temporarily install AC condenser (22) and four *kit* brackets (180) on intercooler (19) with four bolt/captive washers (21). DO NOT tighten.

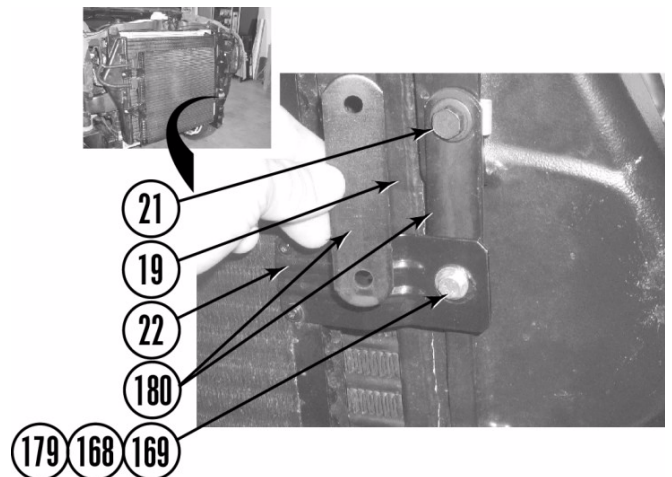

- c. Measure approximately three inches down from the original position of the AC line holes (181) and mark core support (20). Use new current position of AC line to locate new holes.
- d. Before performing the next two steps, if necessary, remove four bolt/captive washers (21), AC condenser (22), and four *kit* brackets (180) from intercooler (19).
- e. Drill new holes (182) in core support (20) where marked with a 1/4" drill bit.
- f. Install two push clip standoffs (47) and AC line (48) in new holes (182) on core support (20).
- g. If removed, install AC condenser (22) and four *kit* brackets (180) on intercooler (19) with four bolt/captive washers (21).

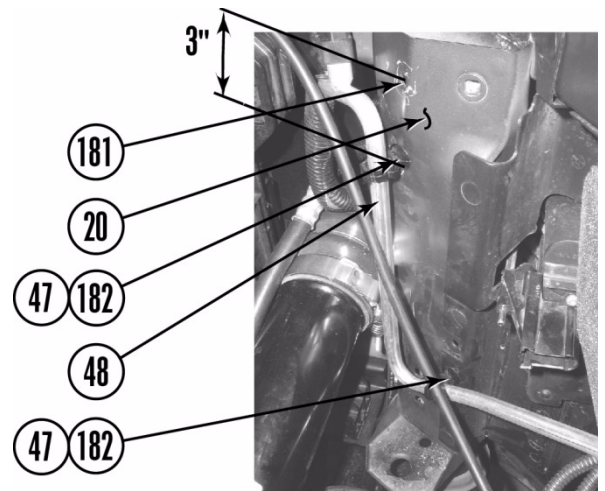

18. Under the hood (air inlet tube).

- a. Position air duct (64) so the end marked "TOP" is at core support (20) as shown.

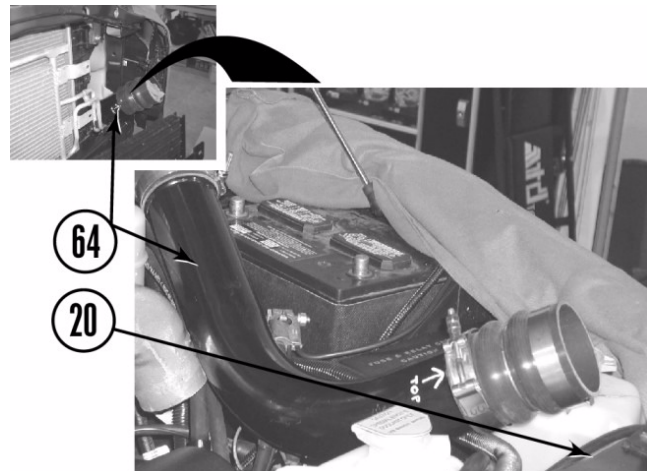

- b. Install flex connector (24) and air tube (59) on intercooler (19) with clamp (61).

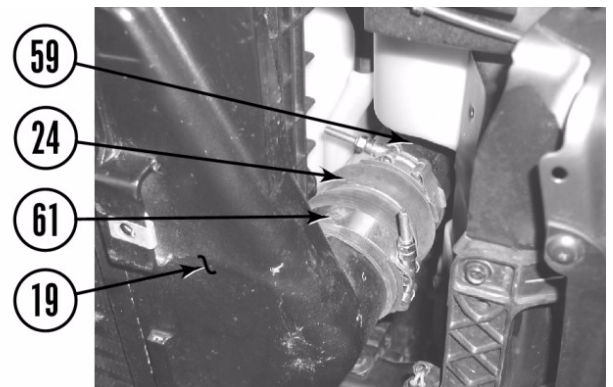

- c. Remove cardboard cover (63) and four bolts (60) from intake manifold (62).

CAUTION
It is necessary to make sure that intake manifold surface is free of debris and old gasket pieces. **Kit** gaskets are self sticking and do not require adhesive.

- d. Position *kit* gaskets (199) above and below *kit* intake riser block (200).
- e. Position *kit* intake riser block (200) on intake manifold (62).

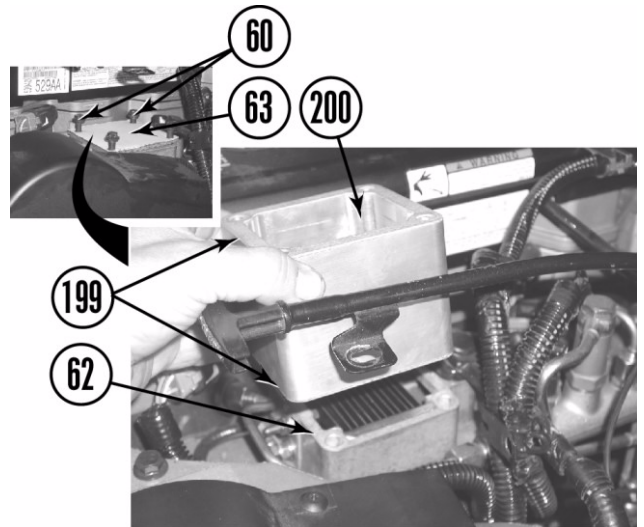

- f. Loosen nut (201) and dipstick tube (202) from engine (184).

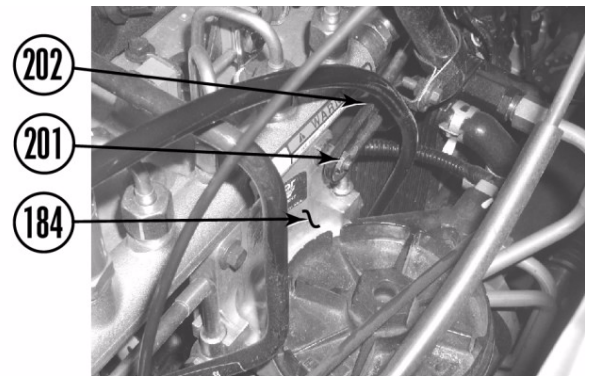

- g. Apply Loctite® to threads of four *kit* 8mm x 160mm bolts (203).
- h. Position dipstick (204) and dipstick tube (202) under air inlet tube (59) as shown.
- i. Install air inlet tube (59) and *kit* intake riser block (200) on intake manifold (62) with four *kit* 8mm x 160mm bolts (203) and four *kit* 8mm washers (176).

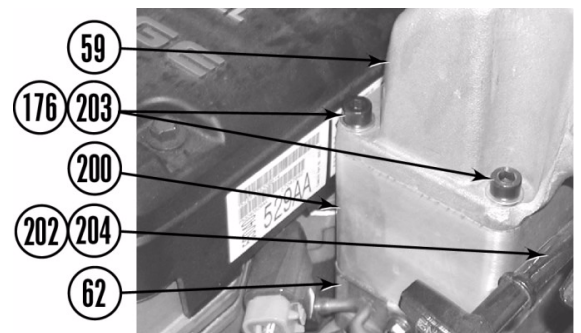

- j. Install dipstick (204) and dipstick tube (202) on air inlet tube (59) with *kit* dipstick tube spacer (205) and *kit* 8mm x 100mm bolt (206) as shown.

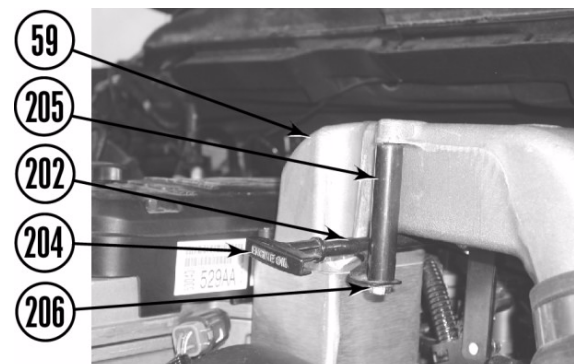

- k. Tighten nut (201) and dip stick tube (202) on engine (184).

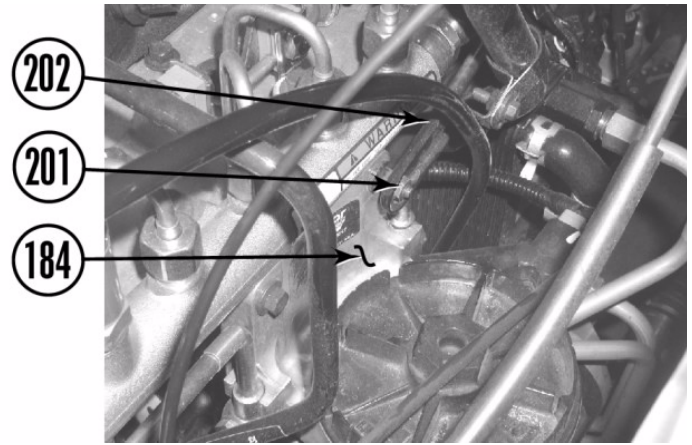

- l. Install flex-connector (24) on air inlet tube (59) with clamp (61).

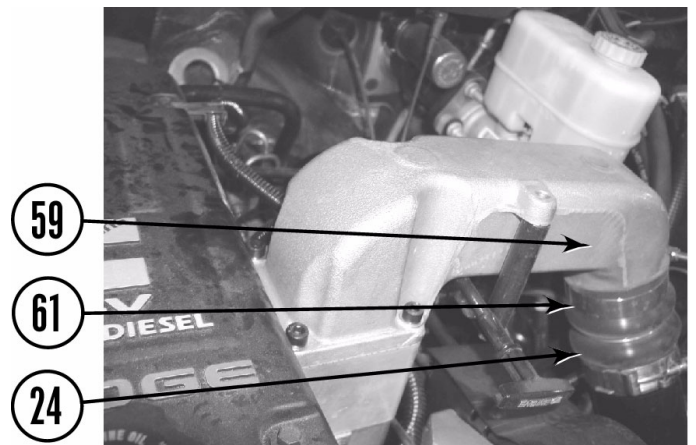

- m. Install *kit* engine wire harness bracket (207) on intake air tube (59) with nut (56).

- n. Install three wire harness clamps (57) on *kit* engine wire harness bracket (207) with *kit* 1/4" SAE washer (168) and *kit* 1/4" nylock nut (169).

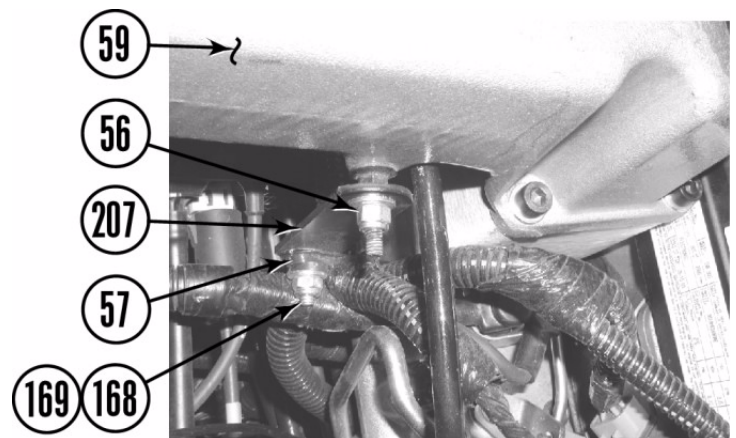

19. Under the hood (air filter box).

- a. Remove bolt with stud (45) and bolt (208) from core support (20).
- b. Install bolt (208) and bolt with stud (45) in opposite holes in core support (20) as shown.

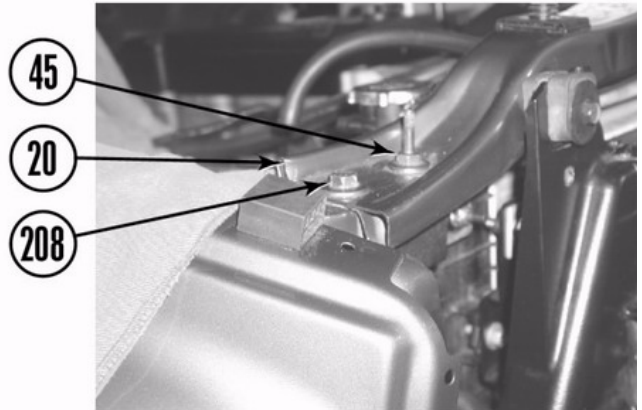
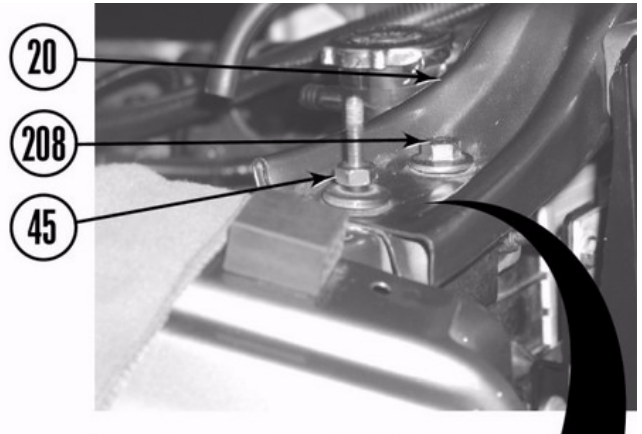

- c. Remove two grommets (209) from battery box support tabs (46). Mark and trim battery box support tabs from battery box (210). Ensure a smooth surface area where tabs were removed from.

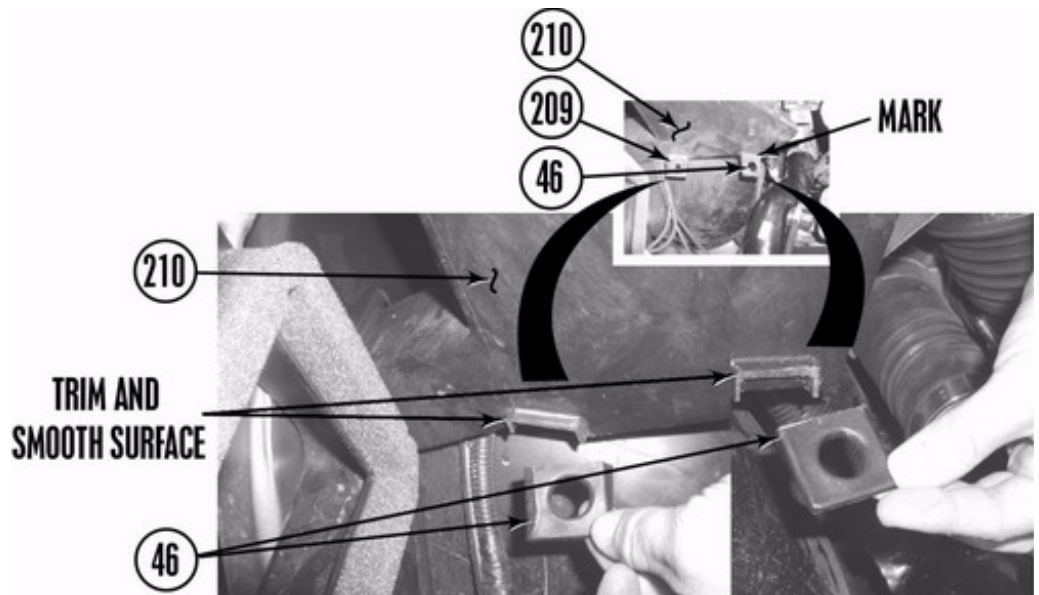

- d. Remove eight screws (211), wiring harness push clip (84), and passenger side wheel well (86) from vehicle.

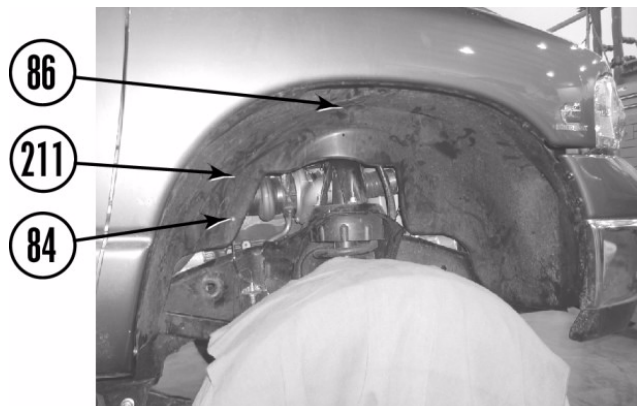

- e. Remove hole template (212) from back cover of instructions. Place hole template underneath and on the back side of the battery box (210) as illustrated. Mark hole locations.
- f. Drill hole locations using a 5/16" drill bit.

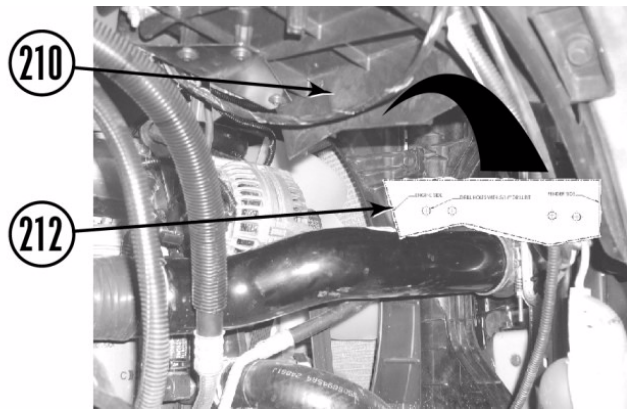

- g. Install two *kit* air box brackets (213 and 214) on battery box (210) with four *kit* 1/4" x 1" bolts (167) eight *kit* 1/4" SAE washers (168) and four *kit* 1/4" nylock nuts (169) as shown.
- h. Install two grommets (209) on two *kit* air box brackets (213 and 214).
- i. Remove four bolts (215) and two solenoids (216) from bracket (217).
- j. Remove three screws (218), wiring harness push clip (219), and bracket (217) from under battery box (210).

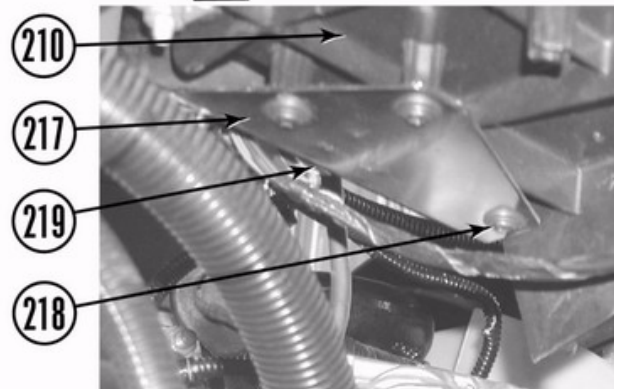
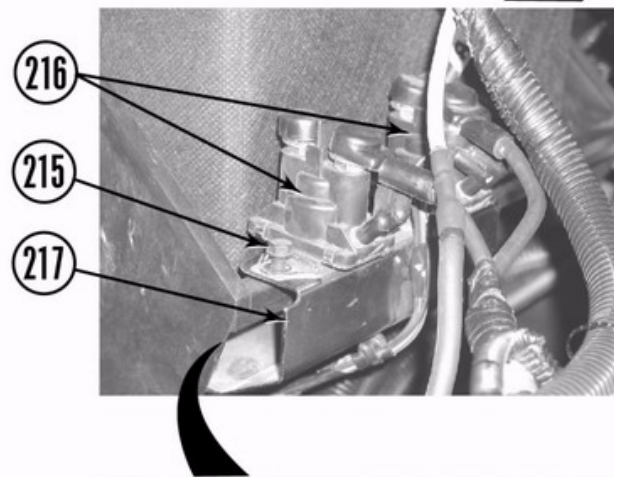
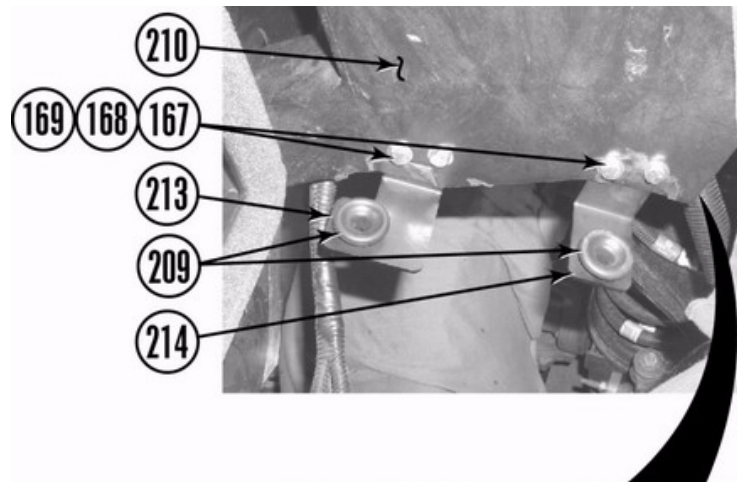

- k. Install *kit* solenoid bracket (220) under battery box (210) with three screws (218). Install wiring harness push clip (219) on *kit* solenoid bracket.

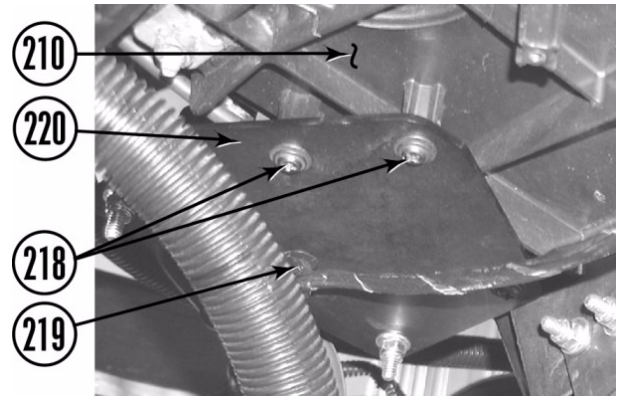

- l. Install two solenoids (216) on *kit* solenoid bracket (220) with four *kit* 1/4" x 1" bolts (167) eight *kit* 1/4" SAE washers (168) and four *kit* 1/4" nylock nuts (169).

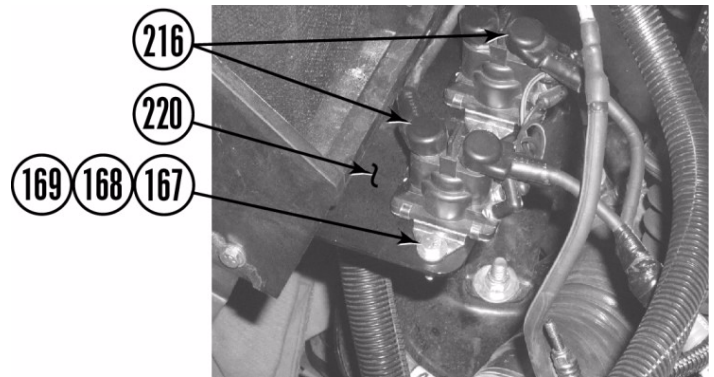

- m. Install *kit* air filter housing bracket (221), *kit* 1/4" x 1" bolt (167), *kit* 1/4" SAE washer (168) and nut (44) on bolt with stud (45) as shown.

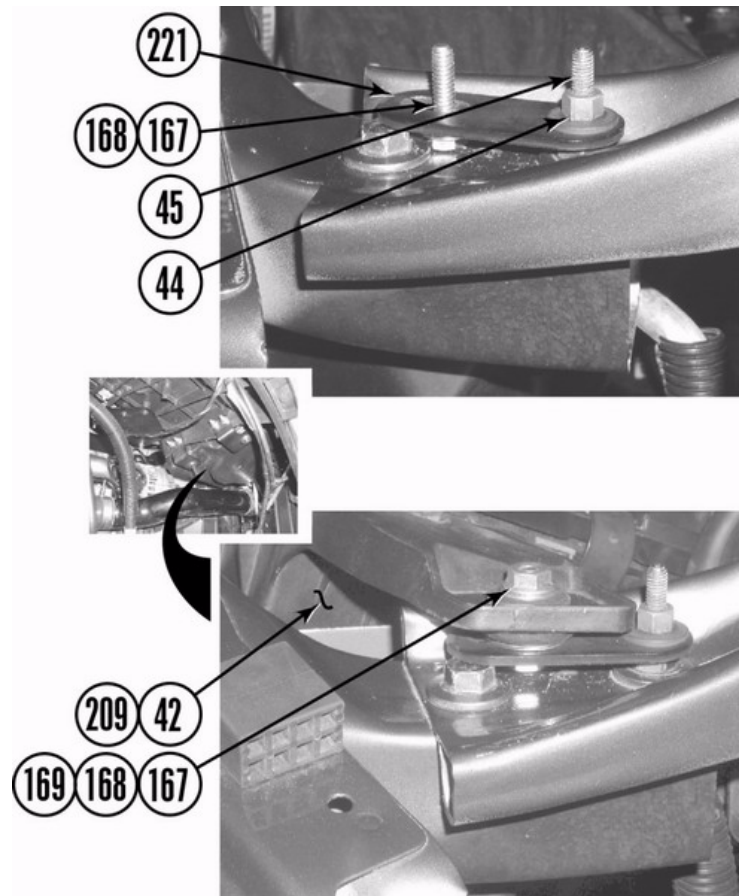

- n. Position lower air filter housing (42) in two grommets (209).
- o. Install lower air filter housing (42) on *kit* 1/4" x 1" bolt (167) with *kit* 1/4" SAE washer (168) and *kit* 1/4" nylock nut (169).

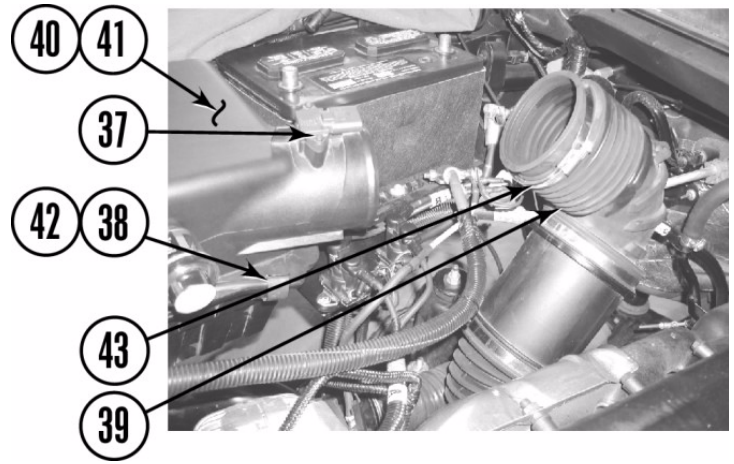

- p. Install air filter (41), air box cover (40), and three clamps (38) on lower air filter housing (42).
- q. Install wiring harness clip (37), air intake hose (43), and hose clamp (39) on air box cover (40).

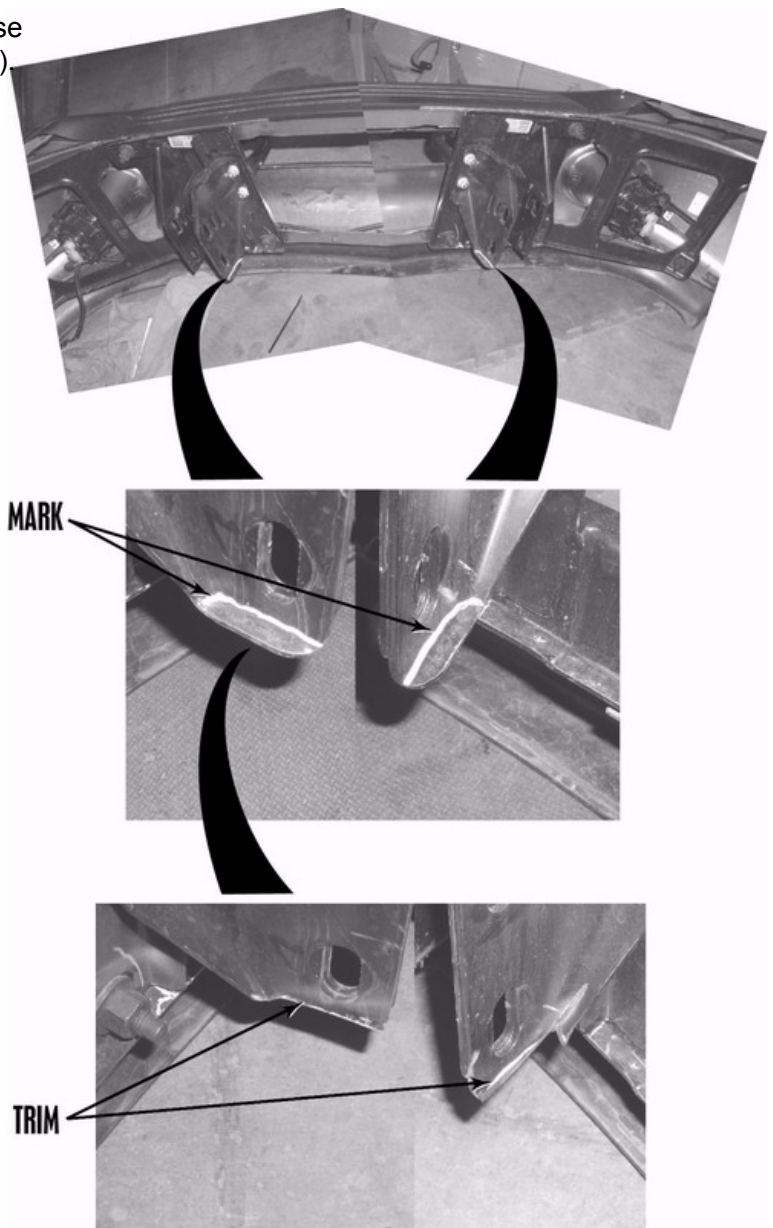

r. Install overflow tube (35) on radiator (27).

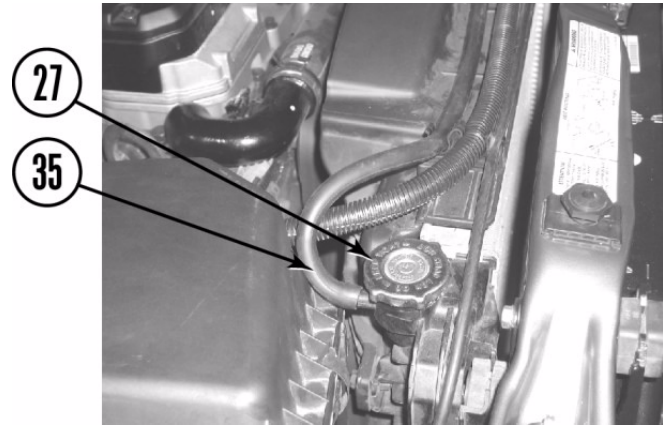

s. Install passenger side wheel well (86) on vehicle with eight screws (211) and wiring harness push clip (84).

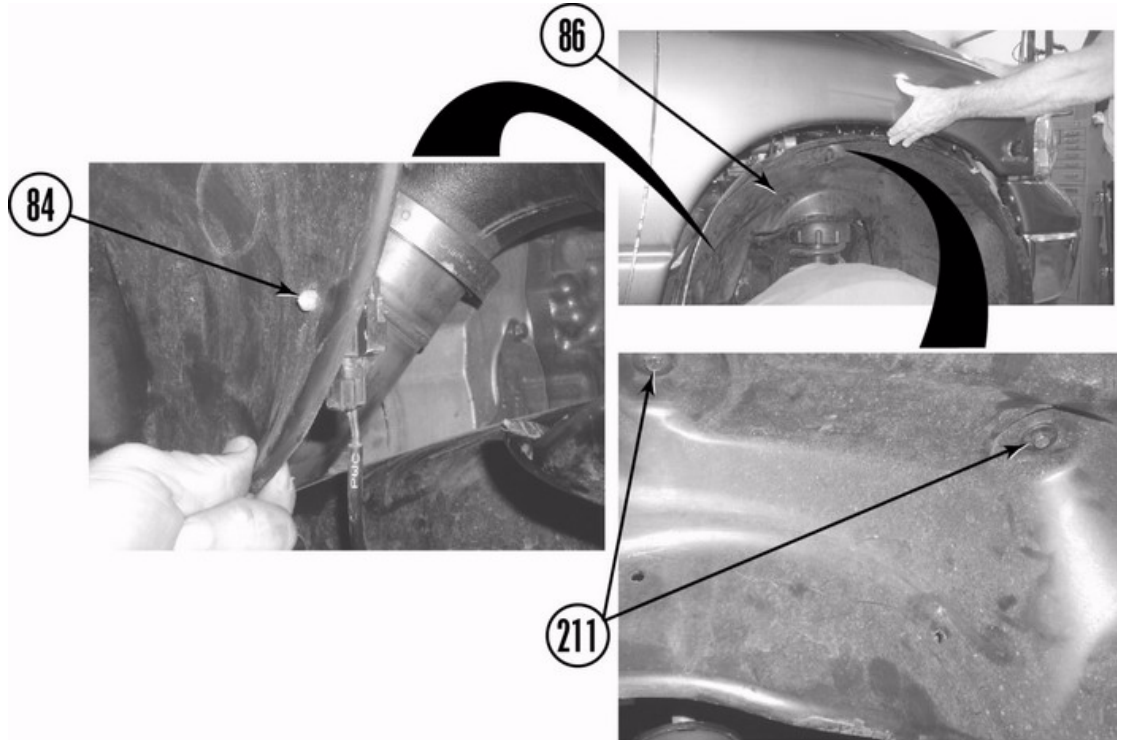

t. If removed, install two clips (84) on driver and passenger side wheel wells (85 and 86).

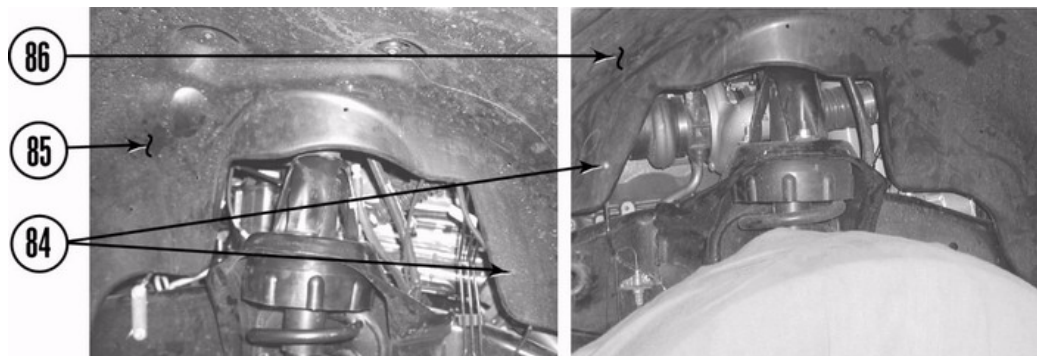

20. Install the front bumper.

- a. If necessary, trim both sides of two front bumper brackets (222) as shown (next page). Test fit the front bumper on vehicle; DO NOT install.
- b. Coat threads of double bolts and bolts (15 and 150) with Loctite®.

NOTE
Installing the front bumper requires two people, one to position and hold the front bumper and another to install the brackets and hardware.

- c. Install two *kit* 2 3/4" spacer tubes (224) between upper holes of front bumper brackets (222) and four *kit* front bumper brackets (225) with two *kit* 12mm x 1.75 x 100mm bolts (150), four *kit* 7/16" USS washers (147), and two *kit* 12mm nylock nuts (226). Do not tighten. Position head of *kit* bolts (150) toward middle of front bumper (9).

- d. Position front bumper (9) on frame (16). Ensure front edges of wheel wells (85 and 86) engage in slots on sides of front bumper and raise bumper until bottom holes on front bumper brackets (222) align with upper holes on frame (16).

- e. Install four *kit* bumper brackets (225), four *kit* thick washers (227), two front bumper brackets (222), and front bumper (9) on frame (16) with two double bolt fasteners (15) and four nut/captive washers (14). Do not tighten.

- f. Check measurements between front bumper (9) and front fenders (10). Adjust bumper to cab clearance and tighten nuts (14 and 226) and bolts (15 and 150). to 55 lb-ft.

- g. Connect wire connector (11) to wiring harness (13). Slide red safety latch (12) to locked position on wire connector. Install wiring harness on front bumper (9).

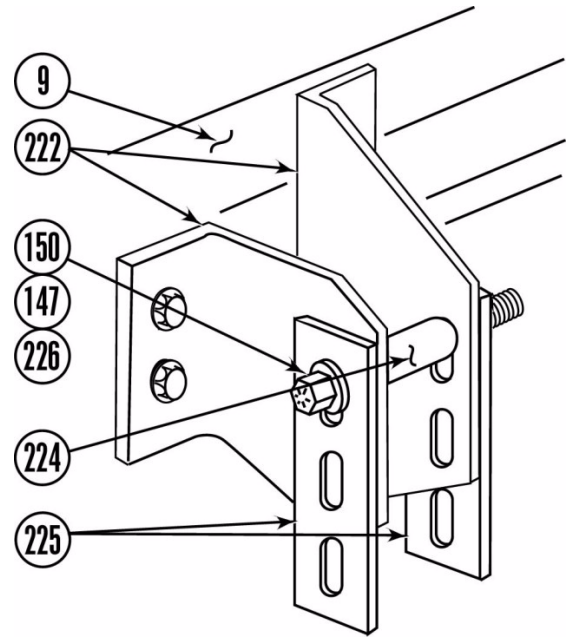

(Passenger Side Shown)

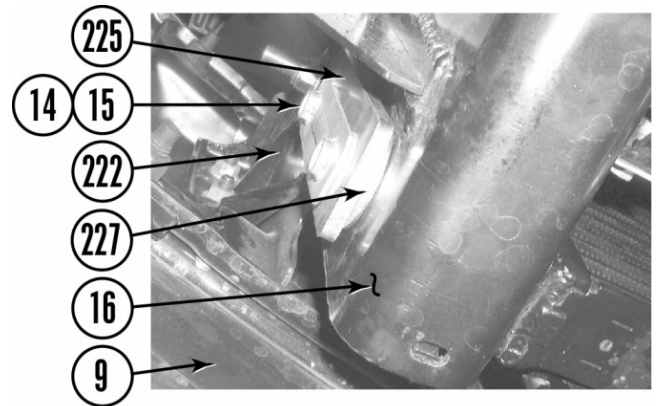

DRIVER SIDE SHOWN

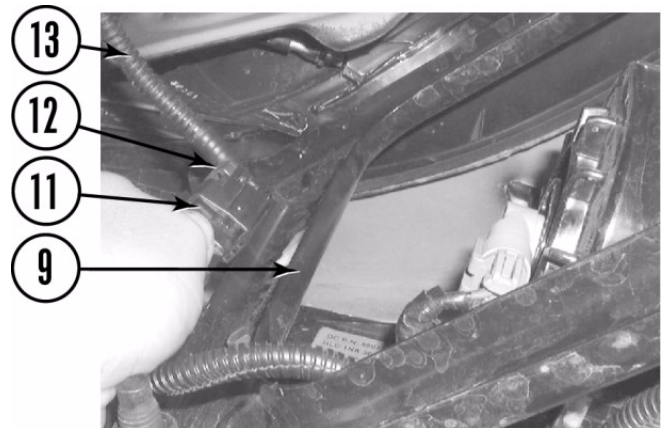

21. Spare tire carrier.

- a. Position *kit* spare tire carrier (228) on crossmember (119) as shown and start driver side bolt (118).

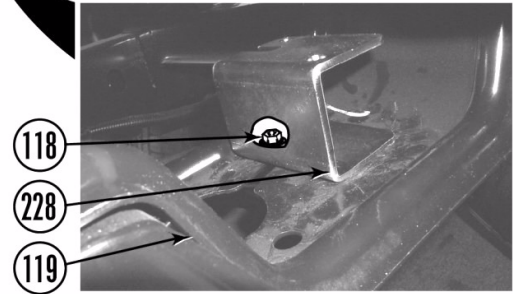

- b. Position spare tire crank mechanism (117) through hole in crossmember (119). Position spare tire crank mechanism on *kit* spare tire carrier (228) and turn *kit* bracket toward front of vehicle to slide spare tire crank mechanism cable (229) through slot in *kit* spare tire carrier. Start passenger side bolt (118) and tighten both bolts.

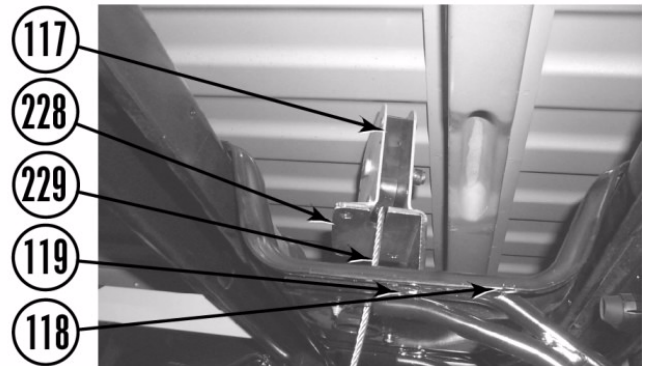

- c. Install spare tire crank mechanism (117) on *kit* spare tire carrier (228) with two *kit* 1/4" x 1" bolts (167), four *kit* 1/4" SAE washers (168), and two *kit* 1/4" nylock nuts (169).

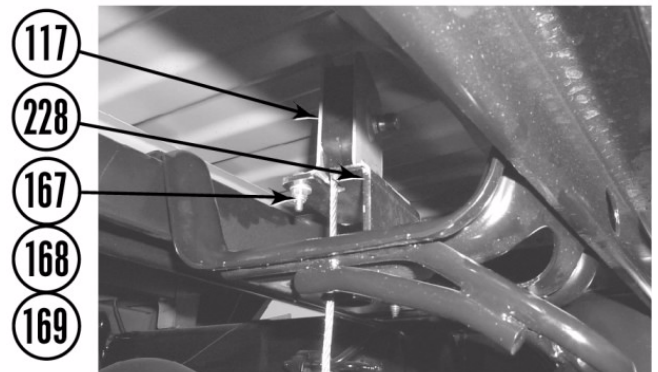

- d. Remove plastic locator (229), two harness clips (230), and harness (231) from crossmember (119). Install plastic locator (229) in *kit* ratchet tube bracket (232).

- e. Position ratchet tube (116) through plastic locator (229) and install ratchet tube on spare tire crank mechanism (117) with clip (115).

- f. Install *kit* ratchet tube bracket (232) on crossmember (119) with two *kit* 1/4" x 1" bolts (167), four *kit* 1/4" SAE washers (168), and two *kit* 1/4" nylock nuts (169).

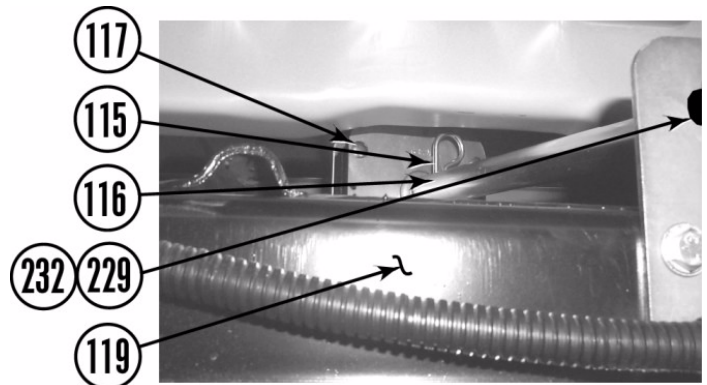

- g. Install harness (231) on crossmember (119) with *kit* zip tie (29).
- h. Raise spare tire (see owner's manual).

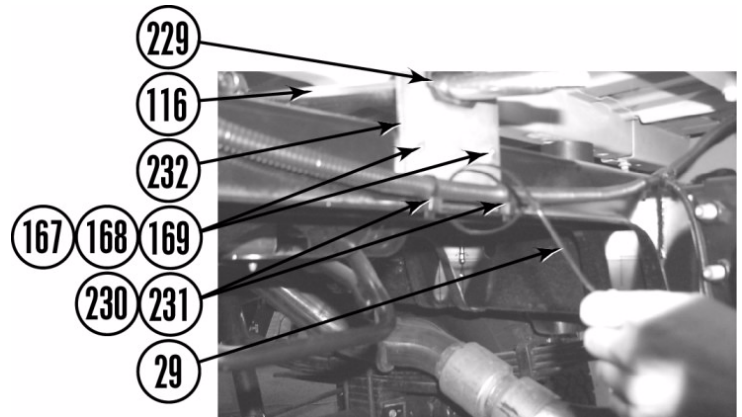

⚠WARNING
 The following procedure is intended only to enhance the appearance of the vehicle. The rear bumper will no longer be rated for towing of any kind. Towing with the rear bumper after it has been lifted can result in death, serious personal injury, or damage to the vehicle. Towing after the bumper has been lifted should be accomplished using a rated Class III receiver type hitch.

22. Install the rear bumper.

- a. Coat threads of bolts (111, 112, and 233) with Loctite®.
- b. Install two *kit* rear bumper brackets (234) on frame (16) with six bolts (111 and 112). Do not tighten.

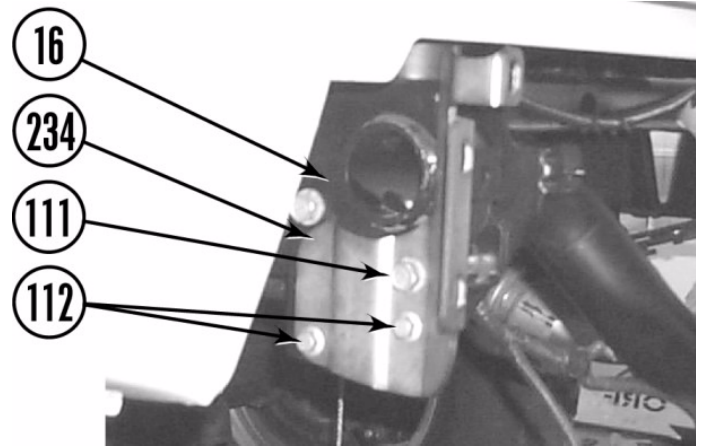

- c. Install *kit* middle bumper bracket (235) on trailer hitch (109) (or frame (16) if no hitch) with two bolts (110). Do not tighten.

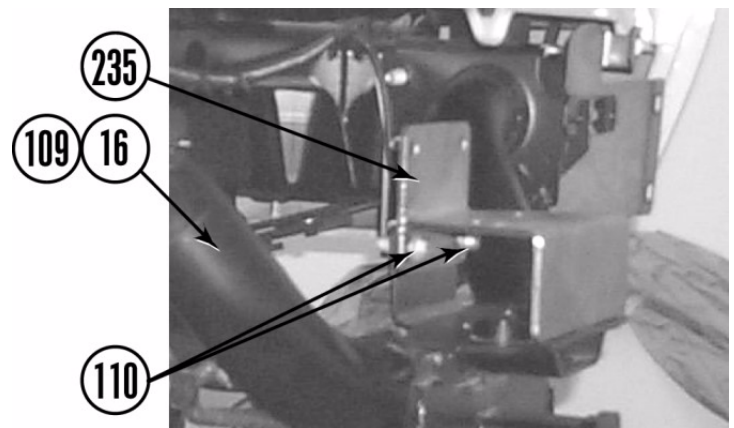

- d. Install rear bumper (96) on two *kit* rear bumper brackets (234) with two double bolt fasteners (114) and four nuts (113). Do not tighten.

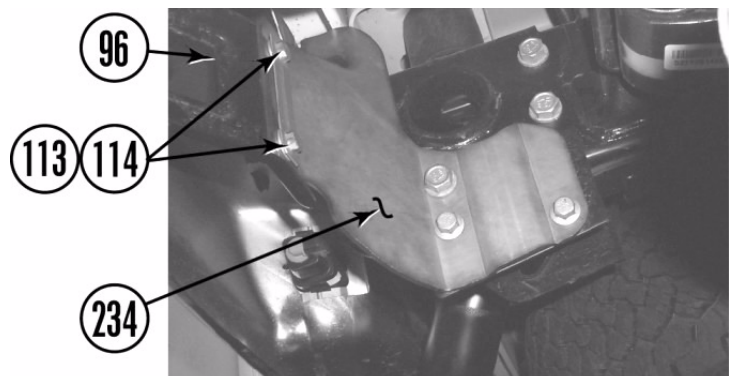

- e. Install rear bumper (96) on *kit* middle bumper bracket (235) with two *kit* 7/16" x 1 1/2" bolts (233), four *kit* 7/16" USS washers (147), and two *kit* 7/16" nylock nuts (164). Do not tighten.

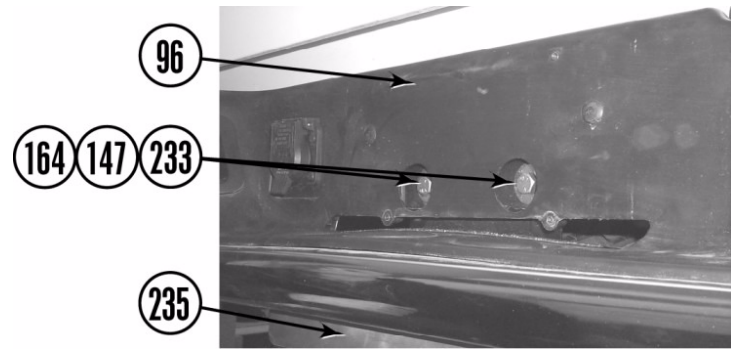

- f. Install two bolts (108) through two *kit* rear bumper brackets (234) and rear bumper (96). Do not tighten.
- g. Adjust bumper to bed clearance and tighten bolts (111, 112, and 233) and nuts (113 and 167) to 55 lb-ft.

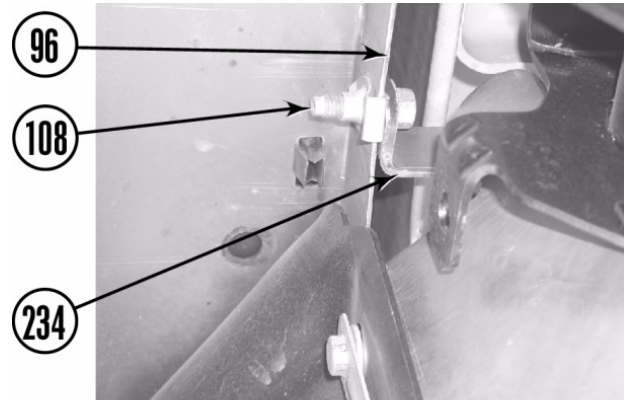

- h. Connect hitch electrical connector (104) on rear bumper connector (105). Slide red locking tab (103) to locked position on hitch wiring connector.

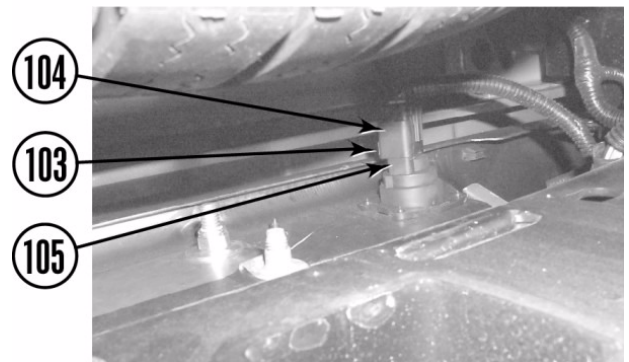

- i. Install two connectors (101) on license plate lights (102).

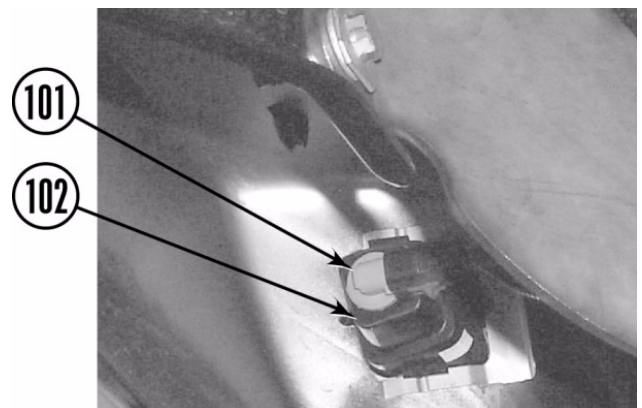

- j. Install license plate (107) on rear bumper (96) with four screws (106).

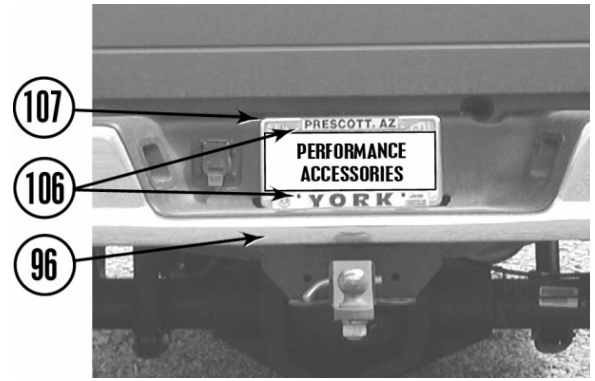

23. Install bed crush blocks.

⚠WARNING
A certified welder should perform all welding.

- a. Weld four *kit* crush blocks (30) on frame (16).

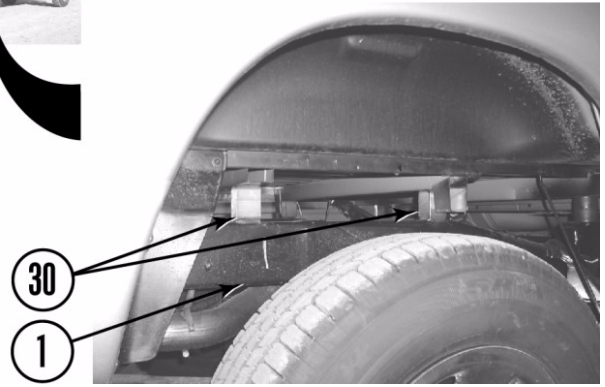

D. After installation is complete.

- 1. Install air bag fuses.

Install two air bag fuses #52 and #53 (6 and 7) in fuse panel (8).

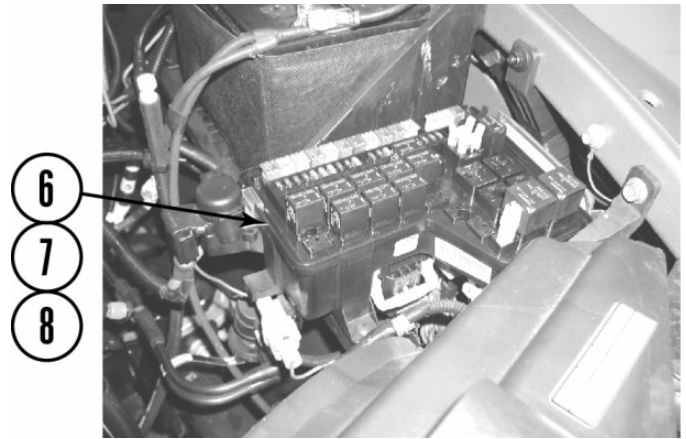

- a. Install cover (5) and tighten thumb wheel (4).

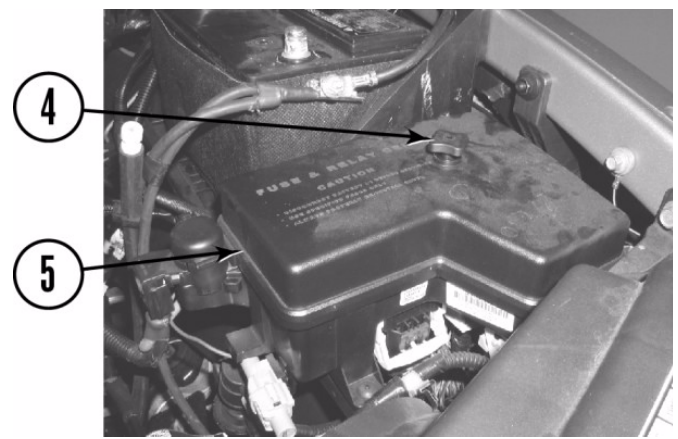

2. Connect both sets of battery cables.
 - a. Connect both sets of battery cables to the battery (3). Be sure to connect two positive cables (2) first, then two negative cables (1).

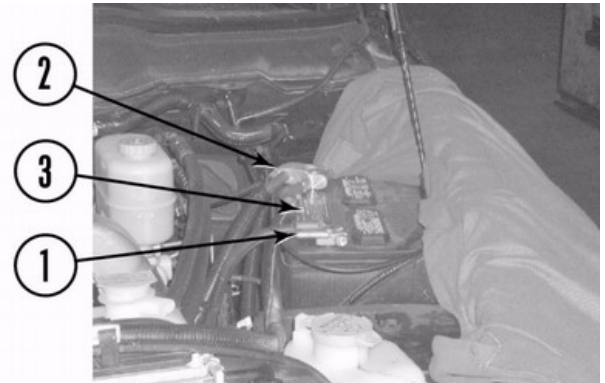
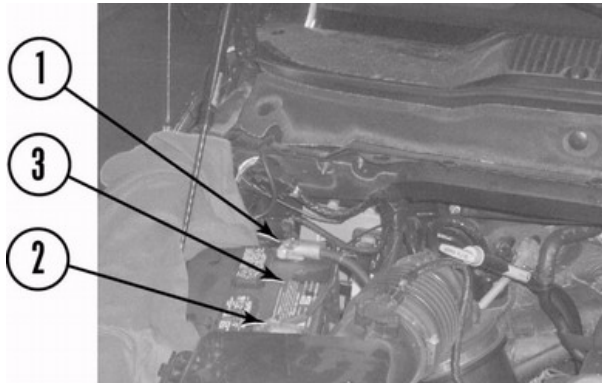

3. **Manual-shift 4WD:** Check transfer case shift lever operation. Ensure there is complete engagement in all ranges. If necessary, adjust shift linkage rod (135).
4. Apply *kit* warning label (sticker) to the dash in plain sight of all vehicle occupants.
5. Double check the vehicle.

⚠CAUTION

Retorque all fasteners after 500 miles and after off road use. All body lift components should be visually inspected and fasteners retorqued during routine vehicle servicing.

- a. Check all mounting hardware to ensure it is properly tightened.
- b. Check all wires, hoses, cables, etc. to ensure they have been properly connected and there is ample slack. With the number of hoses on this vehicle, it is vital that this be checked thoroughly.
- c. Check vehicle electrical system.
- d. Start vehicle and check the steering in both directions to ensure that there is no bind. Check clutch operation. Check the operation of the brake system and the parking brake. Check both shift levers' operation. Ensure that there is proper engagement in all gears and 4 wheel drive ranges.

⚠WARNING

If the engine cooling system is hot, the coolant will be HOT and UNDER PRESSURE. To prevent serious personal injury, wait until the cooling system is completely cool before removing the cap from the radiator.

- e. Check coolant level. Fill coolant to the proper level (refer to the Owner's Manual).
- f. Test drive vehicle in all gears and 4 wheel drive ranges. Pay close attention to all vehicle systems. Check all hardware again in 500 miles and as part of your regular maintenance schedule.

⚠CAUTION

Performance Automotive Group does not recommend any particular wheel and tire combinations for use with its body lifts and cannot assume responsibility for the customer's choice of wheels and tires. Reference your owner's manual for recommended tire sizes and warnings related to the use of oversized tires. Larger wheel and tire combinations increase stress and wear on steering and suspension components, which leads to increased maintenance and higher risk for component failure. Larger wheel and tire combinations also alter speedometer calibration, braking effectiveness, center of gravity, and handling characteristics. Consult with an experienced local off road shop to find what wheel and tire combinations work best with your vehicle.

⚠NOTE

All warranty information, instruction sheets, and other documents regarding the installation of this product must be retained by the vehicle owner. Information contained in the instructions and on the warranty card will be required for any warranty claims. The vehicle owner needs to understand the modifications made to his vehicle and how they affect vehicle handling and performance. Failure to provide the customer with this information can result in damage to the vehicle and severe personal injury.

E. Accessories

61002: 2" Coil Spring Leveling Spacers

Kit Parts List

Callout Qty.

(30)	4	Block , bed crush ⁽¹⁾
(200)	1	Block , intake riser ⁽²⁾
(143)	16	Block , lift, 3" height x 3" diameter
(174)	2	Bolt , 6mm-1.00 x 30mm
(174)	2	Bolt , 8mm-1.25 x 30mm
(206)	1	Bolt , 8mm-1.25 x 100mm
(203)	4	Bolt , 8mm-1.25 x 160mm
(149)	6	Bolt , 12mm-1.75 x 100mm
(150)	4	Bolt , 12mm-1.75 x 120mm
(146)	8	Bolt , 12mm-1.75 x 180mm
(179)	9	Bolt , 1/4" x 3/4"
(167)	14	Bolt , 1/4" x 1"
(160)	1	Bolt , 5/16" x 1"
(170)	1	Bolt , 3/8" x 1-1/4" socket head
(163)	2	Bolt , 7/16" x 1"
(233)	2	Bolt , 7/16" x 1 1/2"
(180)	4	Bracket , A/C condenser ⁽³⁾
(213)	1	Bracket , air box ("L")
(214)	1	Bracket , air box ("L")
(221)	1	Bracket , air filter housing ⁽⁴⁾
(207)	1	Bracket , engine wire harness ⁽⁵⁾
(225)	4	Bracket , front bumper ⁽⁶⁾
(166)	1	Bracket , ground strap extension ⁽⁷⁾
(185)	1	Bracket , negative cable extension ⁽⁸⁾
(159)	1	Bracket , parking brake
(188)	1	Bracket , positive cable extension ⁽⁹⁾
(172)	2	Bracket , radiator lower, driver side
(172)	2	Bracket , radiator lower, passenger side
(175)	2	Bracket , radiator upper ⁽³⁾
(234)	1	Bracket , rear bumper, driver side
(235)	1	Bracket , rear bumper, middle
(234)	1	Bracket , rear bumper, passenger side
(220)	1	Bracket , solenoid
(228)	1	Bracket , spare tire crank
(232)	1	Bracket , spare tire ratchet tube
(178)	1	Bracket , transmission cooler, driver side
(178)	1	Bracket , transmission cooler, pass. side

Callout Qty.

(156)	1	Extension , fuel filler (1 1/2" x 5" pipe)
(158)	1	Extension , fuel filler vent (3/4" x 3" pipe)
(132)	1	Extension , manual trans. shift lever ⁽¹⁰⁾
(171)	1	Extension , steering
(199)	2	Gasket , intake riser block
(53)	1	Hose , heater (5/8" x 12")
(54)	4	Hose clamp , #10
(157)	2	Hose clamp , #36
	1	Label (sticker), warning to driver
	1	Label (sticker), logo
	1	Loctite ®, 6ml bottle
(177)	2	Nut , 6mm-1.00 nylock
(177)	2	Nut , 8mm-1.25 nylock
(226)	2	Nut , 12mm-1.75 nylock
(169)	29	Nut , 1/4" nylock
(162)	1	Nut , 5/16" nylock
(164)	4	Nut , 7/16" nylock
(224)	2	Spacer tube , front bumper bracket ⁽¹¹⁾
(205)	1	Spacer tube , dipstick (3 1/2")
(176)	8	Washer , 8mm
(168)	51	Washer , 1/4" SAE
(161)	2	Washer , 5/16" USS
(147)	28	Washer , 7/16" USS
(227)	4	Washer , 1/2" (1 3/4" OD, 3/16" thick)
(29)	4	Zip tie

(1) Rectangular steel tube.

(2) Square aluminum, four holes.

(3) Flat, 3" hole-to-hole, without stud.

(4) Flat; oblong hole at one end, normal hole at other.

(5) Flat, 3" hole-to-hole, with stud.

(6) Flat, 2" x 8", three oblong holes.

(7) Slight "S"-bend, obround hole.

(8) Flat, but 30-degree bend at one end; two holes.

(9) Flat, 2 3/8" hole-to-hole.

(10) Steel rod, 5/8" x 3".

(11) Steel pipe, 3/4" x 2 1/4".

