



# 1955-56 Chevrolet Full-Size

*without* Factory Air

Gen 5 Evaporator Kit

Center Vent (561550)

Center Vent Deluxe (561554)



18865 Goll St. San Antonio, TX 78266

Phone: 800-862-6658

Sales: [sales@vintageair.com](mailto:sales@vintageair.com)

Tech Support: [tech@vintageair.com](mailto:tech@vintageair.com)

[www.vintageair.com](http://www.vintageair.com)



www.vintageair.com

# Table of Contents

Cover.....	1
Table of Contents.....	2
Packing List/Parts Disclaimer.....	3
Information Page.....	4
Wiring Notice.....	5
Engine Compartment Disassembly, Passenger Compartment Disassembly, Compressor and Brackets.....	6-7
Lubricating O-rings, Properly Seated O-ring Land, Evaporator Preparation.....	8
Evaporator Preparation (Cont.).....	9-10
Firewall Insulation, Defrost Duct Installation.....	11
A/C Hose Routing, Evaporator Installation.....	12-14
Rubber Boot & Firewall Cover Installation, Passenger Compartment Wiring.....	15
ECU Installation, Defrost Plenum Installation.....	16
Under Dash Louver Installation, Heater Hose & Heater Control Valve Installation.....	17
Heater Hose & Heater Control Valve Installation (Cont.), A/C Hose Installation.....	18
Engine Compartment Wiring.....	19-21
Drain Hose Installation.....	22
Final Steps: Installation Check.....	23
Glove Box Installation, Final Steps: Completing the Install.....	24
ECU, Control Panel & Duct Hose Routing.....	25
Quality Crimp Guideline.....	26
Gen 5 Wiring Diagram.....	27
Gen 5 Wiring Connection Instruction.....	28
Operation of Controls (Standard Control).....	29
Operation of Controls (Deluxe Control).....	30
Troubleshooting Guide.....	31
Troubleshooting Guide (Cont.), Advanced Diagnostics and Troubleshooting Guide.....	32
Packing List.....	33



www.vintageair.com

## Packing List: Evaporator Kit (561550)

No.	Qty.	Part No.	Description
1.	1	765200	Gen 5 Magnum Max Module with 404 ECU
2.	1	781550	Accessory Kit

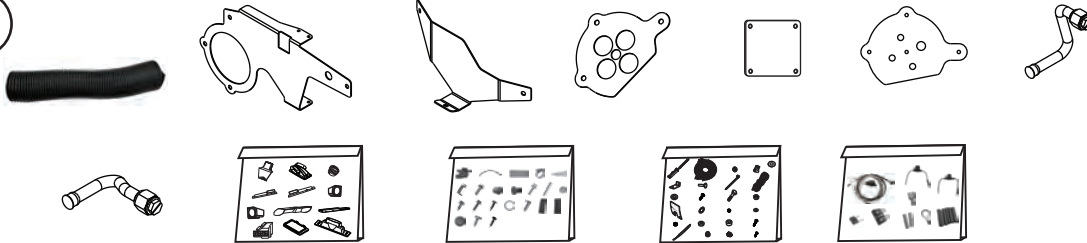
**\*\* Before beginning installation, open all packages and check contents of shipment. Please report any shortages directly to Vintage Air within 15 days. After 15 days, Vintage Air will not be responsible for missing or damaged items.**

1

Gen 5 Magnum Max  
Module with 404 ECU  
765200



2



Accessory Kit  
781550

NOTE: Images may not depict actual parts and quantities.  
Refer to packing list for actual parts and quantities.

## Packing List: Evaporator Kit (561554)

No.	Qty.	Part No.	Description
1.	1	765200	Gen 5 Magnum Max Module with 404 ECU
2.	1	781554	Accessory Kit

**\*\* Before beginning installation, open all packages and check contents of shipment. Please report any shortages directly to Vintage Air within 15 days. After 15 days, Vintage Air will not be responsible for missing or damaged items.**

1

Gen 5 Magnum Max  
Evaporator Module  
765200



2



Accessory Kit  
781554  
Deluxe

NOTE: Images may not depict actual parts and quantities.  
Refer to packing list for actual parts and quantities.



www.vintageair.com

## Important Notice—Please Read

*For Maximum System Performance, Vintage Air Recommends the Following:*

**NOTE:** Vintage Air systems are designed to operate with R134a refrigerant only. Use of any other refrigerant could damage your A/C system and/or vehicle, and possibly cause a fire, in addition to potentially voiding the warranties of the A/C system and its components.

### Refrigerant Capacities:

**Vintage Air System:** 1.8 lbs. (28.8 oz.) or 816 grams of **R134a**, charged by weight with a quality charging station or scale. **NOTE: Use of the proper type and amount of refrigerant is critical to system operation and performance.**

**Other Systems:** Consult manufacturer's guidelines.

### Lubricant Capacities:

**New Vintage Air-Supplied Sanden Compressor:** No additional oil needed (Compressor is shipped with proper oil charge).

**All Other Compressors:** Consult manufacturer (Some compressors are shipped dry and will need oil added).

### Safety Switches

Your Vintage Air system is equipped with a binary pressure safety switch. A binary switch disengages the compressor clutch in cases of extreme low pressure conditions (refrigerant loss) or excessively high head pressure (406 PSI) to prevent compressor damage or hose rupture. A trinary switch combines Hi/Lo pressure protection with an electric fan operation signal at 254 PSI, and should be substituted for use with electric fans. Compressor safety switches are extremely important since an A/C system relies on refrigerant to circulate lubricant.

### Service Info:

**Protect Your Investment:** Prior to assembly, it is critical that the compressor, evaporator, A/C hoses and fittings, hardlines, condenser and receiver/drier remain capped. Removing caps prior to assembly will allow moisture, insects and debris into the components, possibly leading to reduced performance and/or premature failure of your A/C system. This is especially important with the receiver/drier.

Additionally, when caps are removed for assembly, **BE CAREFUL!** Some components are shipped under pressure with dry nitrogen.

**Evacuate the System for 35-45 Minutes:** Ensure that system components (Drier, compressor, evaporator and condenser) are at a temperature of at least 85°F. On a cool day, the components can be heated with a heat gun **or** by running the engine with the heater on before evacuating. Leak check and charge to specifications.

### Bolts Passing Through Cowl and/or Firewall:

To ensure a watertight seal between the passenger compartment and the vehicle exterior, for all bolts passing through the cowl and/or firewall, Vintage Air recommends coating the threads with silicone prior to installation.

### Heater Hose (not included with this kit):

Heater hose may be purchased from Vintage Air (Part#31800-VUD) or your local parts retailer. Routing and required length will vary based on installer preference.



www.vintageair.com

## Important Wiring Notice—Please Read

*Some vehicles may have had some or all of their radio interference capacitors removed. There should be a capacitor found at each of the following locations:*

- 1. On the positive terminal of the ignition coil.**
- 2. If there is a generator, on the armature terminal of the generator.**
- 3. If there is a generator, on the battery terminal of the voltage regulator.**

Most alternators have a capacitor installed internally to eliminate what is called “whining” as the engine is revved. If whining is heard in the radio, or just to be extra cautious, a radio interference capacitor can be added to the battery terminal of the alternator.

It is also important that the battery lead is in good shape and that the ground leads are not compromised. There should be a heavy ground from the battery to the engine block, and additional grounds to the body and chassis.

If these precautions are not observed, it is possible for voltage spikes to be present on the battery leads. These spikes come from ignition systems and charging systems, and from switching some of the vehicle’s other systems on and off. Modern computer-operated equipment can be sensitive to voltage spikes on the power leads, which can cause unexpected resets, strange behavior and/or permanent damage.

Vintage Air strives to harden our products against these types of electrical noise, but there is a point where a vehicle’s electrical system can be degraded so much that nothing can help.

Radio interference capacitors should be available at most auto and truck parts suppliers. They typically are cylindrical in shape, a little over an inch long and a little over a half-inch in diameter, and they have a single lead coming from one end of the cylinder with a terminal on the end of the wire, as well as a mounting clip which is screwed into a good ground on the vehicle. The specific value of the capacitance is not too significant in comparison to ignition capacitors that are matched with the coil to reduce pitting of the points.

- Care must be taken, when installing the compressor lead, not to short it to ground. The compressor lead must not be connected to a condenser fan or to any other auxiliary device. Shorting to ground or connecting to a condenser fan or any other auxiliary device may damage wiring or the compressor relay, and/or cause a malfunction.
- When installing ground leads on Gen 5 systems, the blower control ground and ECU ground must be connected directly to the negative battery post.
- For proper system operation, the heater control valve must be connected to the ECU.



www.vintageair.com

## Engine Compartment Disassembly

**NOTE:** Before starting the installation, check the function of the vehicle (horn, lights, etc.) for proper operation, and study the instructions, illustrations, photos & diagrams.

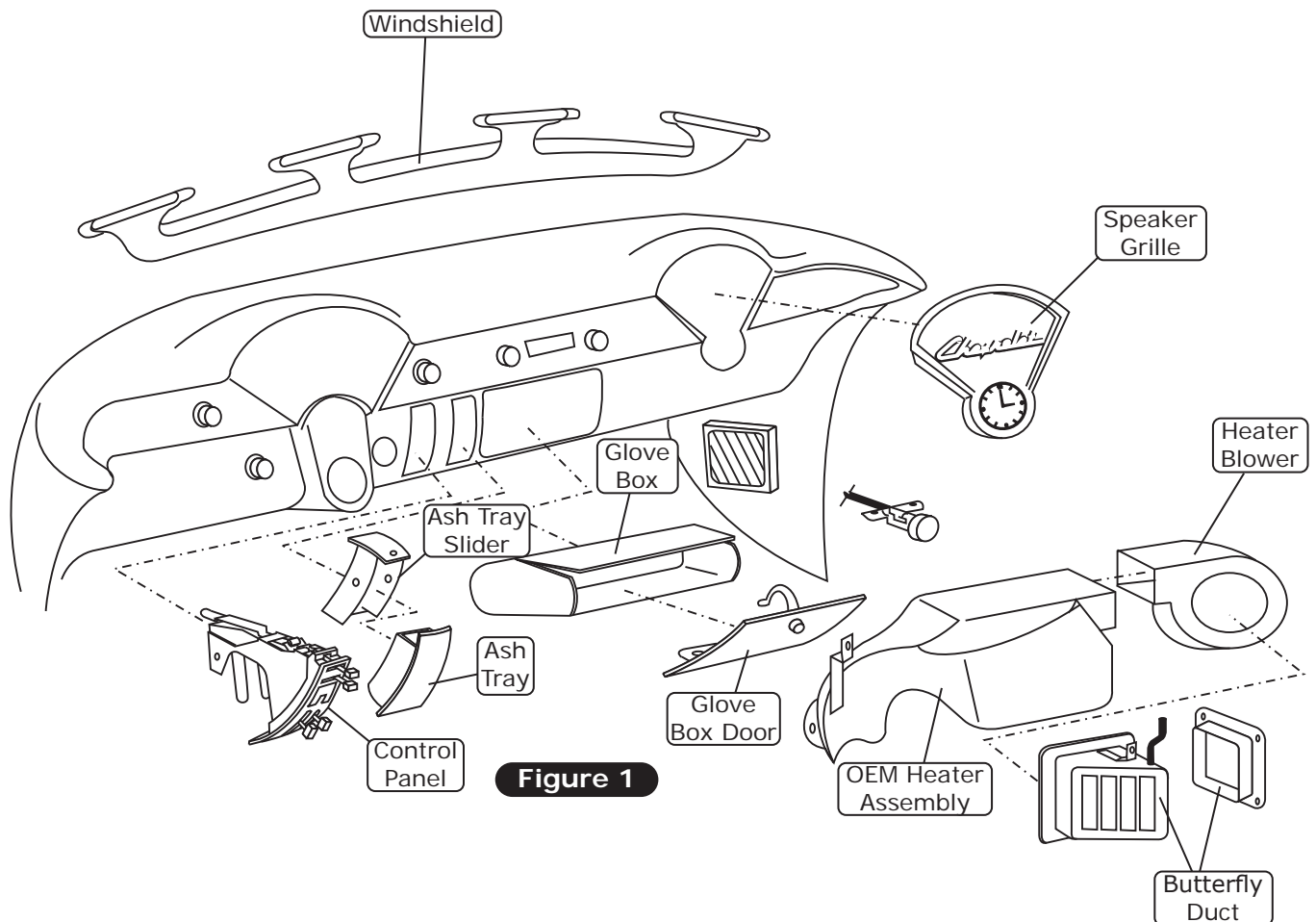
**Perform the following:**

1. Disconnect the battery.
2. Remove the battery and battery tray.
3. Remove the air cleaner.
4. Drain the radiator.
5. Disconnect the heater hoses.

## Passenger Compartment Disassembly

**Perform the following:**

1. Remove the OEM heater assembly by removing the control cables, along with (2) 7/16" nuts on the firewall and (1) under the dash (discard).
2. Remove the heater blower (discard) (See Figure 1, below).







www.vintageair.com

## Passenger Compartment Disassembly (Cont.)

3. Remove the butterfly duct above the passenger-side kick panel vent, as well as the panel flange (See Photo 1, below) (discard). Apply seam sealer/silicone to the new fresh air cap and install it using the (4) #8 x 1/2" pan head screws (See Photos 2 and 3, below).
4. From the engine compartment, install (2) 1" plastic plugs into the OEM heater line openings (See Photo 4, below).
5. Remove the glove box door (retain).
6. Remove the glove box (discard).
7. Remove the original defrost duct from the heater to the windshield (discard).
8. Remove the ash tray (retain).
9. Remove the ash tray slider assembly (retain).
10. Remove the vent and cables from the dash (retain) (See Figure 1, Page 6).
11. Remove the control panel (retain).
12. Remove the passenger-side speaker grille (retain) (See Figure 1, Page 6).

Remove butterfly duct, as well as panel flange

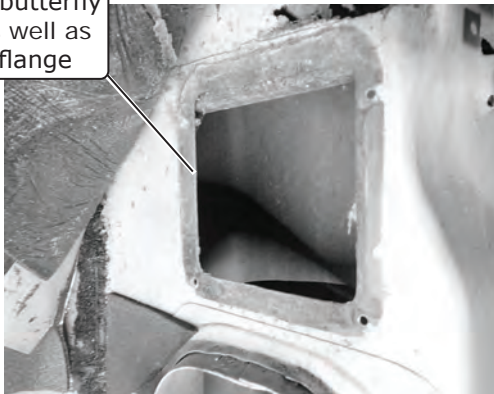


Photo 1

Fresh Air Cap 62108-VCE

Apply seam sealer/silicone

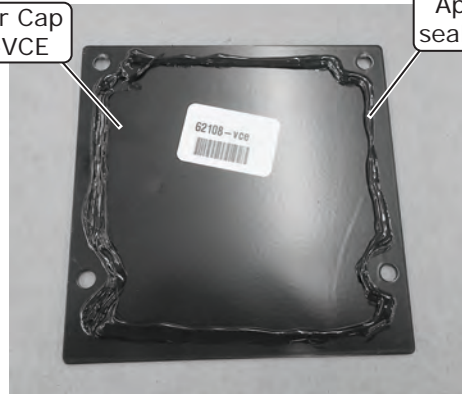


Photo 2

(4) #8 x 1/2" Pan Head Screws

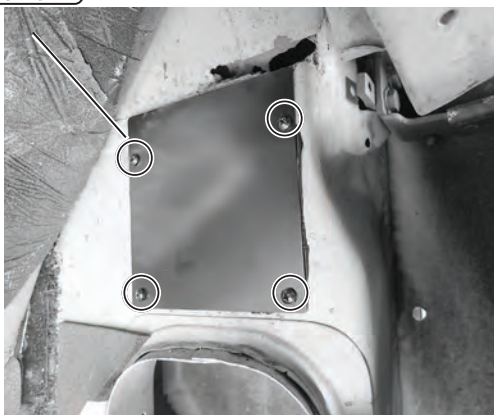


Photo 3

Install (2) 1" plastic plugs into OEM heater line openings

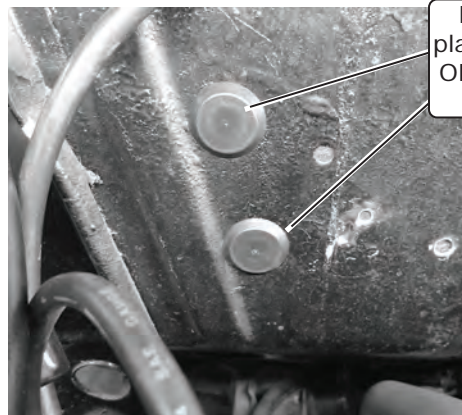


Photo 4

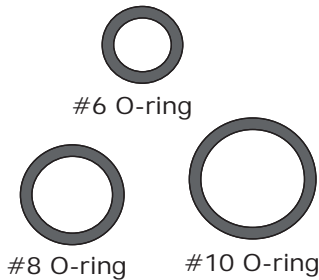
## Compressor and Brackets

1. Refer to separate instructions included with the bracket kit to install the compressor bracket.

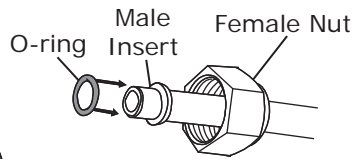


www.vintageair.com

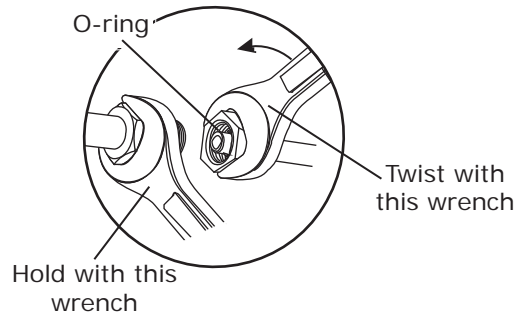
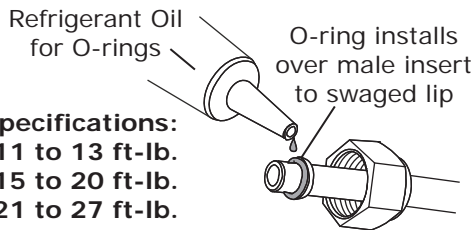
## Lubricating O-rings



**NOTE: Standard torque specifications:**  
#6: 11 to 13 ft-lb.  
#8: 15 to 20 ft-lb.  
#10: 21 to 27 ft-lb.



For a proper seal of fittings: Install supplied O-rings as shown and lubricate with refrigerant oil.



## Properly Seated O-ring Land

When installing a hardline or A/C hose fitting onto the evaporator module, ensure the O-ring land is seated properly (See Photo 1, below). An improperly seated O-ring land (See Photo 2, below) can cause a leak. To properly install the fitting, slide the hardline or A/C hose nut back to expose the O-ring land and seat it onto the evaporator module fitting. Then, slide the hardline or A/C hose nut forward and thread it onto the evaporator module fitting, ensuring the O-ring land does not move or lift.

Properly Seated O-ring Land



Photo 1

Improperly Seated O-ring Land

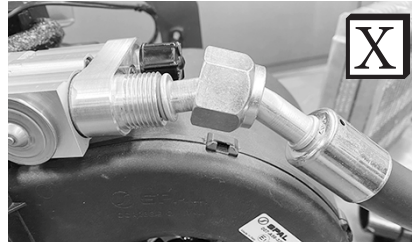


Photo 2

NOTE: Photos shown are for reference only. Fittings may vary depending on kit received.

## Evaporator Preparation

On a workbench, perform the following:

1. Remove the plastic caps and rubber inserts from the evaporator module (See Photos 1 and 2, below).

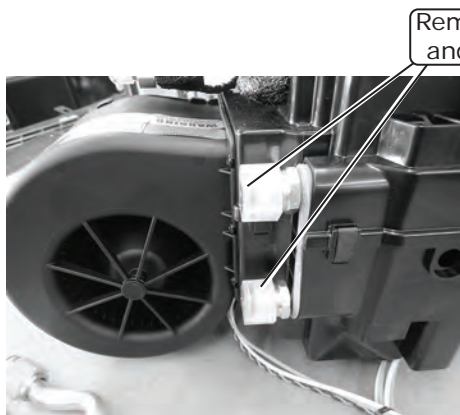


Photo 1

Remove plastic caps and rubber inserts



Photo 2





www.vintageair.com

## Evaporator Preparation (Cont.)

2. Install the upper and lower heater hardlines onto the evaporator module using (2) properly lubricated #10 O-rings (See Lubricating O-rings, Page 8) (See Photos 3, 4 and 5, below). **NOTE: Use back up wrenches on these connections. Hardlines should touch the back of the blower.**
3. Install (3) 1/2" plastic plugs into the back mounting provisions (See Photos 6, 7 and 8, below). This mount will not be used for this application.
4. Using (4) #10 x 5/8" screws and (2) 1/4-20 x 1" serrated flange bolts secure the evaporator firewall bracket to the evaporator module (See Photos 9 and 10, below).

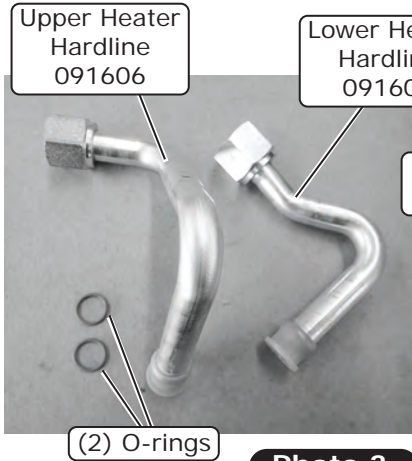


Photo 3

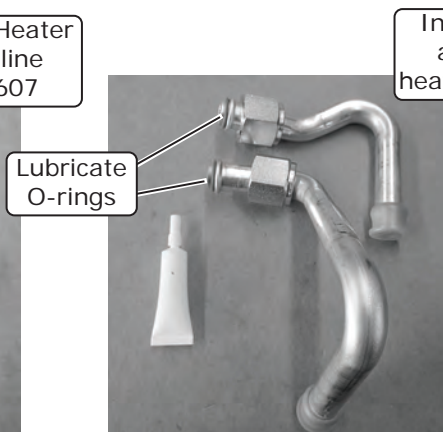


Photo 4

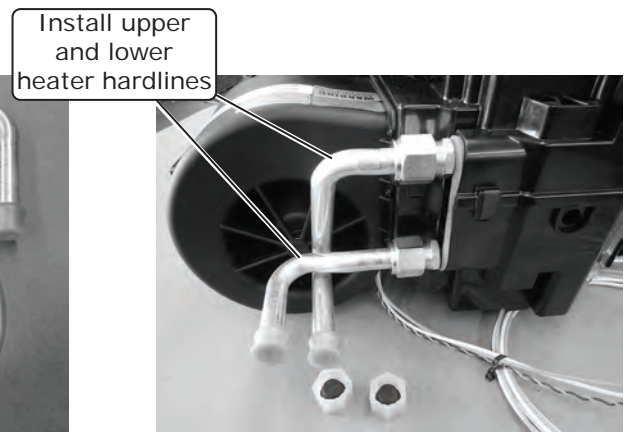


Photo 5

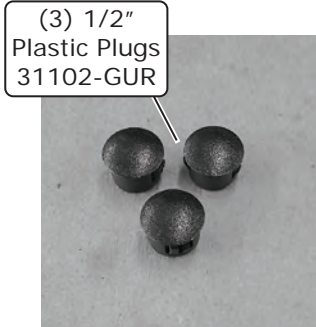


Photo 6



Photo 7



Photo 8

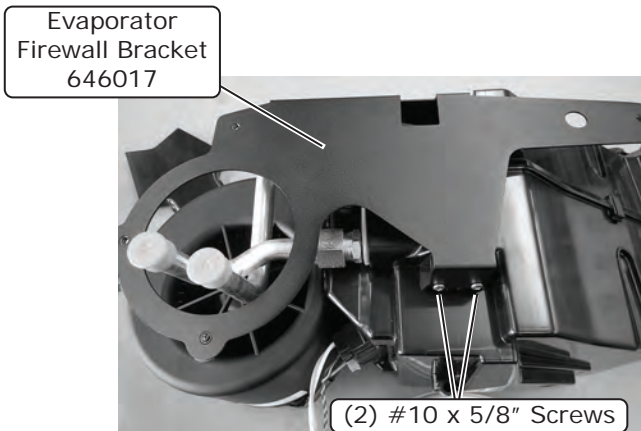


Photo 9

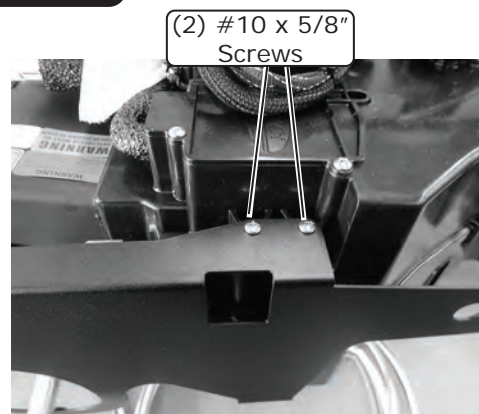


Photo 10



www.vintageair.com

## Evaporator Preparation (Final)

5. Install (2) 1/4-20 x 1 1/2" full-threaded studs into the upper and lower mounting weld nut of the evaporator firewall bracket until 1/2" is visible (See Photos 11 and 12, below).
6. Using (4) spring clips (2 per side) install the center vent plenum adapter onto the evaporator module (See Photos 13, 14 and 15, below).
7. Using (2) spring clips install the floor plenum onto the evaporator module (See Photos 16 and 17, below).

Install (2) 1/4-20 x 1 1/2" full-threaded studs until 1/2" is visible



Photo 11

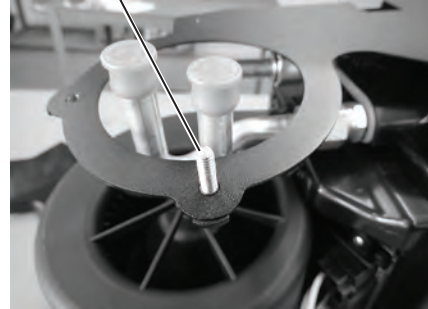


Photo 12

(4) Spring Clips

Center Vent Plenum Adapter 628124



Photo 13

Install center vent plenum adapter

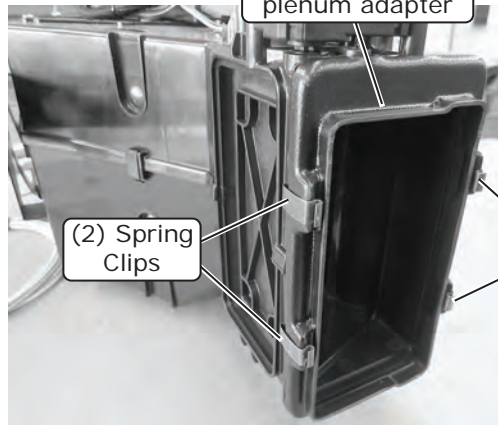


Photo 14

(2) Spring Clips

(2) Spring Clips



Spring Clip Installed

Photo 15

Floor Plenum 625338

Install floor plenum

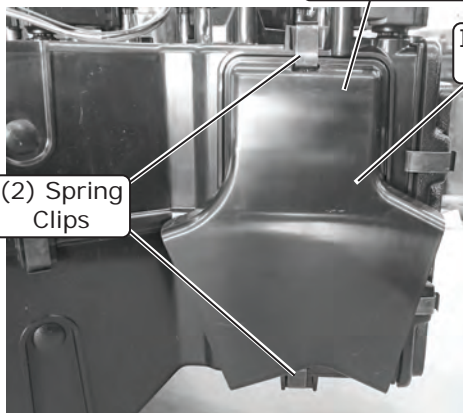


Photo 16



Spring Clip Installed

Photo 17





www.vintageair.com

## Firewall Insulation

**NOTE:** Clean the area of the inner dash to the right of the radio, this is the area the ECU will be mounted. For proper system operation, Vintage Air recommends using Dynaliner (461500-VIP) heat-blocking insulation in the area around the evaporator module (firewall, kick panel, inner cowl, firewall covers). Due to tight clearance for the evaporator module between the firewall and dash, Vintage Air recommends an insulation thickness of no more than 1/8".

1. Remove the OEM insulation and clean the surface where the new insulation will be installed (See Photo 1, below).
2. Install the insulation pieces using spray adhesive and cover the seams using duct tape (See Photo 2, below).

Remove OEM insulation and clean surface where new insulation will be installed

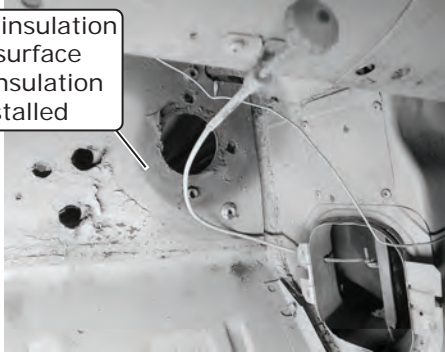


Photo 1

Cover seams using duct tape



Install insulation pieces using spray adhesive

Photo 2

## Defrost Duct Installation

**NOTE:** For 1955 vehicles, use (2) defrost ducts (490658). Installation follows same steps shown below. The passenger-side defrost duct has a notch for the OEM wire clip (See Photo 1, below). Refer to Duct Hose Routing, Page 25, as well.

1. Locate the driver- and passenger-side defrost ducts. Attach a 12" length of 2 1/2" duct hose to the passenger side-defrost duct and a 26" length of 2 1/2" duct hose to the driver-side defrost duct (See Photo 2, below).
2. Install the (2) defrost ducts onto the OEM defrost duct mounting flanges under the dash, then loosely secure them using (2) #8 x 1/2" wide head screws on each duct (See Photos 3, 4 & 5, below). Adjust the defrost duct as needed to capture the defrost opening and to avoid interference with the windshield wiper cables, then tighten the hardware.

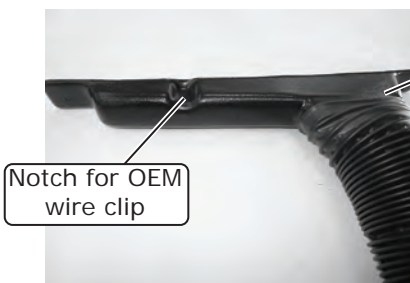


Photo 1

Passenger-Side Defrost Duct 490657

Attach a 12" length of 2 1/2" duct hose

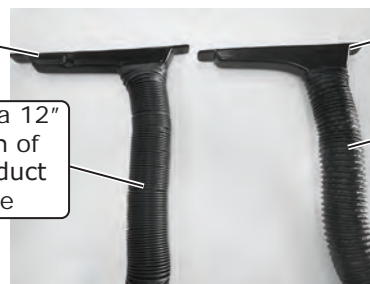


Photo 2

Driver-Side Defrost Duct 490656

Attach a 26" length of 2 1/2" duct hose

Driver-Side Defrost Duct 490656

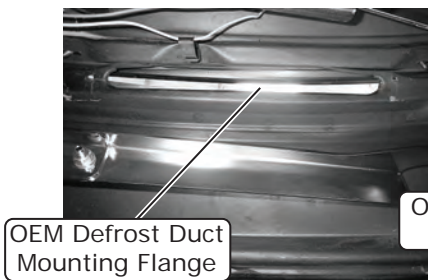
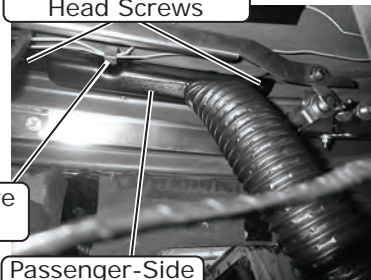


Photo 3

OEM Defrost Duct Mounting Flange

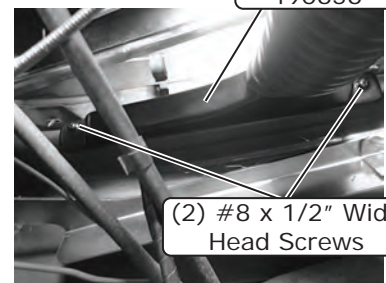
OEM Wire Clip

(2) #8 x 1/2" Wide Head Screws



Passenger-Side Defrost Duct 490657

Photo 4



(2) #8 x 1/2" Wide Head Screws

Photo 5



www.vintageair.com

## A/C Hose Routing

1. Route the 90° fittings of the #6 and #10 A/C hoses through the firewall cover and rubber boot then into the passenger compartment (See Photos 1 and 2, below).

Route 90° fittings of #6 and #10 A/C hoses through firewall cover plate and rubber boot

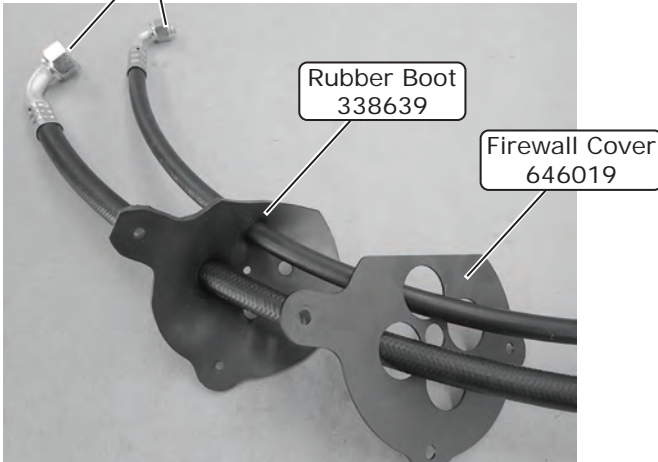


Photo 1

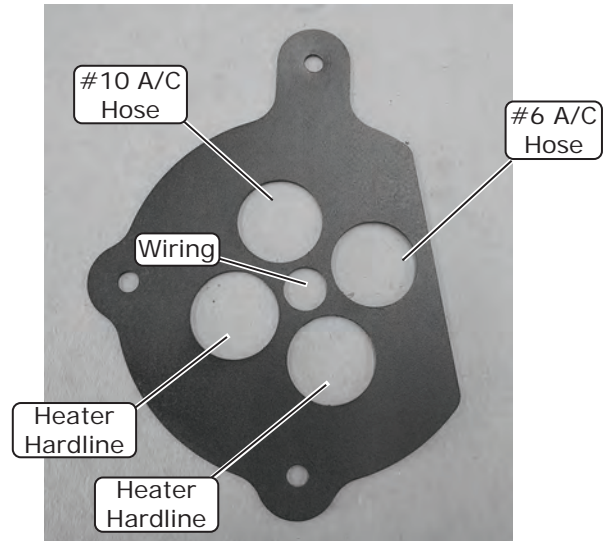


Photo 2

## Evaporator Installation

**NOTE:** To ensure a watertight seal between the passenger compartment and the vehicle exterior, for all bolts passing through the firewall, Vintage Air recommends coating the threads with silicone prior to installation.

1. Place the evaporator module on the passenger-side floorboard (See Photo 1, below).
2. Loosen the (2) screws securing the ECU to the evaporator unit (See Photo 2, below), then remove it from the top of the evaporator.
3. Apply (2) Velcro strips to the back of the ECU (See Photo 3, below).

Place evaporator module on passenger-side floorboard

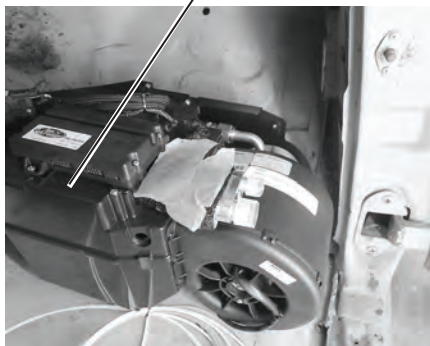


Photo 1

Loosen (2) screws securing ECU to evaporator unit

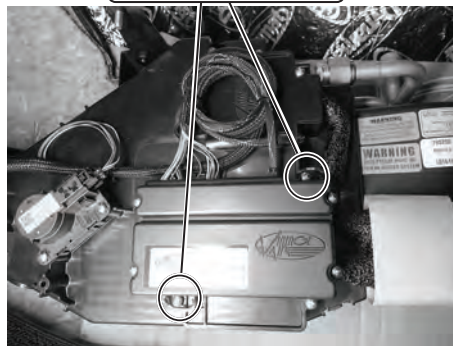


Photo 2

Apply (2) Velcro strips to back of ECU

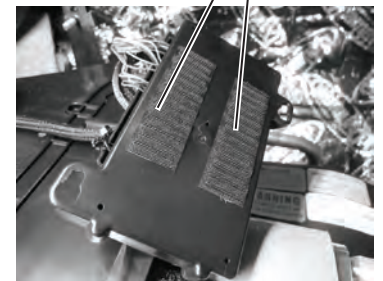


Photo 3





www.vintageair.com

## Evaporator Installation (Cont.)

4. Route the A/C hose fittings through the evaporator firewall bracket (See Photo 4, below) and install the #6 and #10 O-ring onto the A/C hose 90° fittings (See Photo 5, below).
5. Remove the plastic caps and rubber inserts from the block fitting adapter (See Photo 6, below).
6. Properly lubricate the #6 O-ring (See Lubricating O-rings, Page 8), and install the #6 90° fitting onto the block fitting adapter (See Photo 7, below).
7. Properly lubricate the #10 O-ring (See Lubricating O-rings, Page 8), and install the #10 90° fitting onto the block fitting adapter (See Photo 8, below) and cover with the supplied press tape (See Photo 9, below).
8. Route the heater control valve plug (white, yellow, purple) the red, white and blue and heavy gauge orange and white wires along the A/C hoses into the engine compartment leaving 12-15" of wiring in the passenger compartment.
9. Roll the evaporator module into position pulling back slightly on the left side of the evaporator bracket to flex it away from the firewall then use the full-length studs to locate the mounting holes in the firewall.
10. Install (2) well nuts into the front mounting provisions of the module (See Photos 10 and 11, below).

Route A/C hose fittings through evaporator firewall bracket

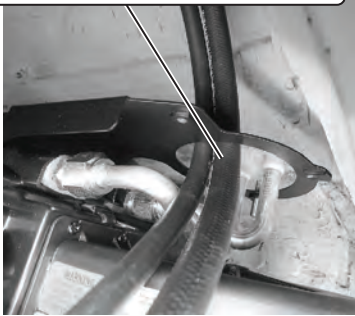


Photo 4

Install #6 and #10 O-rings onto A/C hose 90° fittings

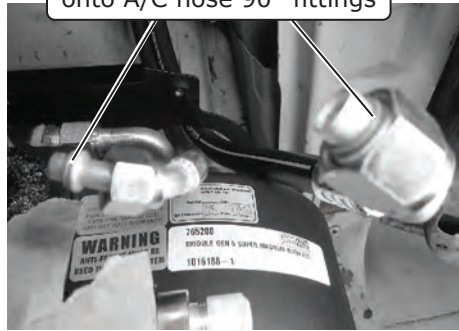


Photo 5

Remove plastic caps and rubber inserts

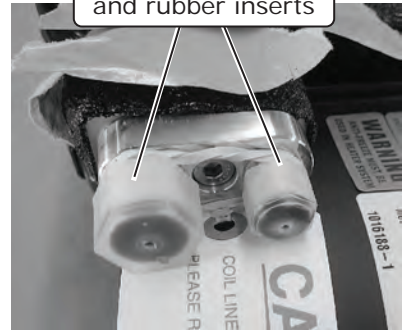


Photo 6

Install #6 90° fitting onto block fitting adapter

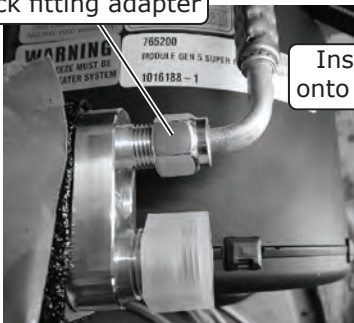


Photo 7

Install #10 90° fitting onto block fitting adapter



Photo 8

Cover with supplied press tape



Photo 9

(2) Well Nuts

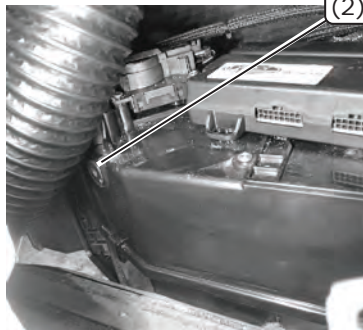


Photo 10

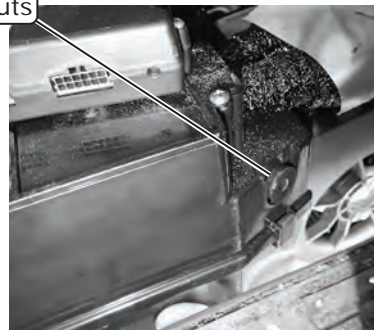


Photo 11

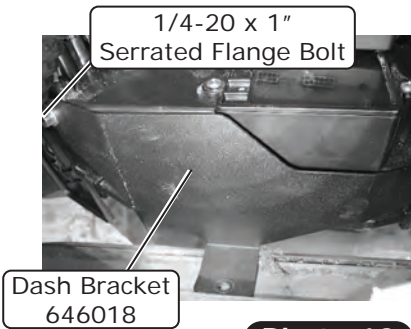




www.vintageair.com

## Evaporator Installation (Final)

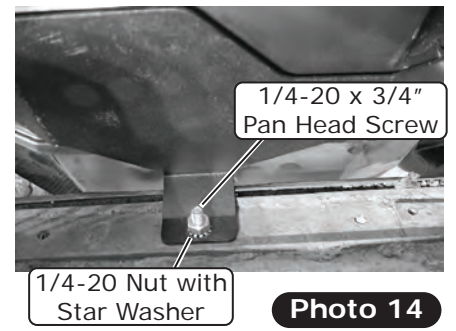
11. Install the dash bracket using (2) 1/4-20 x 1" serrated flange bolts and a 1/4-20 x 3/4" pan head screw and a 1/4-20 nut with star washer (See Photos 12, 13 and 14, below). This will keep the module in place while the rest of the hardware is installed.
12. Install the center vent into the evaporator module. Loosely install the center louver dash bracket onto the under-dash lip using a 1/4-20 x 1/2" bolt and washer (supplied on the center louver plenum assembly) (See Photo 15, below).
13. From the engine compartment, replace the 1/4-20 x 1 1/2" stud and loosely install a 1/4-20 x 3/4" black serrated flange bolt into the firewall bracket (See Photo 16, below).
14. Route the heater control valve plug (white, yellow, purple) the red, white and blue and heavy gauge orange and white wires through the wiring opening into the rubber boot and firewall plate (See A/C Hose Routing Photo 2, Page 12, and Photo 17, below).
15. Route (2) lengths of heater hose (not supplied) through the firewall cover and rubber boot (See Photo 18, below).
16. Install the heater hose onto the heater hardlines. Soapy water will help with ease of installation. The heater hose should be installed approximately 1 1/2" deep inside of the firewall opening. Secure the heater hose to the hardlines using (2) supplied hose clamps (See Photo 19, below).



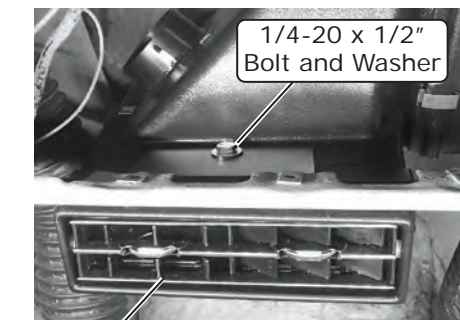
**Photo 12**



**Photo 13**

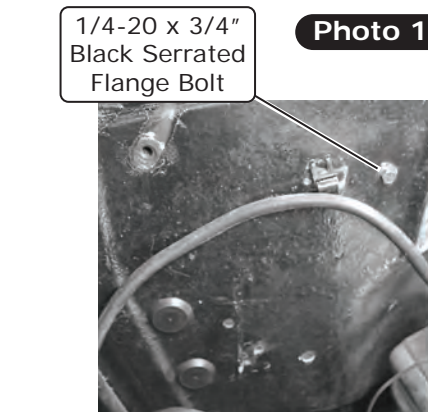


**Photo 14**

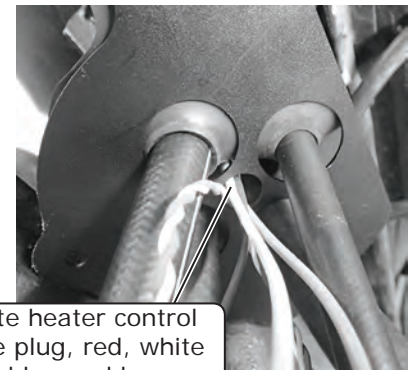


Install center vent

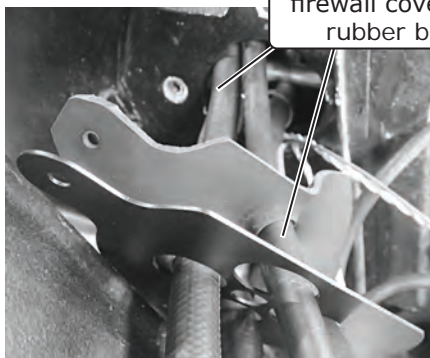
**Photo 15**



**Photo 16**



**Photo 17**



**Photo 18**



**Photo 19**



www.vintageair.com

## Rubber Boot & Firewall Cover Installation

1. Slide the rubber boot and fire wall cover into place over the heater hardlines and loosely secure it to the firewall using (3) 1/4-20 x 3/4" black serrated flange bolts replacing the 1/4-20 x 1/2" full-length studs (See Photo 1, below).
2. Level the evaporator module fore, aft left to right and then tighten all mounting hardware (See Photo 2, below).

(3) 1/4-20 x 3/4"  
Black Serrated  
Flange Bolt

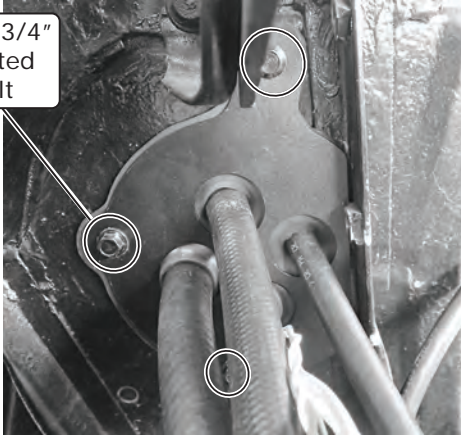


Photo 1

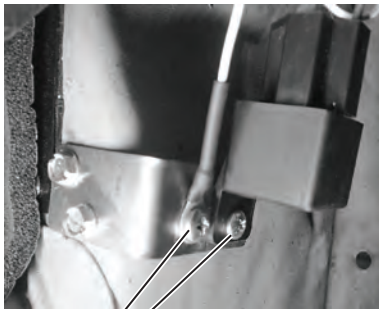
Level evaporator  
module



Photo 2

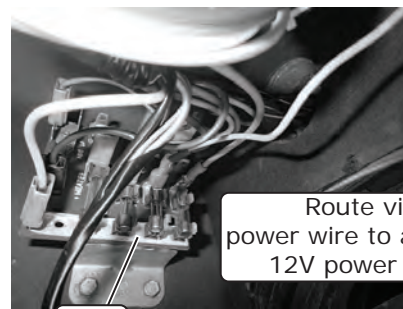
## Passenger Compartment Wiring

1. Select a mounting location for the main relay and the ground eyelet and secure them using the supplied #12 x 1/2" self-tapping screws (See Photo 1, below).
2. Route the violet power wire to a switched 12V power source on the fuse panel (See Photo 2, below).  
**NOTE: This requires a male fuse extension (not supplied).**
3. Connect the tan wire to the factory dash lights to enable control panel backlighting (if applicable).
4. Connect the BSC wiring to the main harness (See Photo 3, below).



Secure main relay and ground  
eyelet using supplied #12 x  
1/2" self-tapping screws

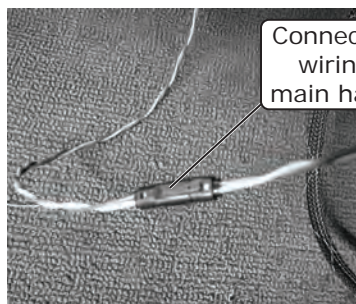
Photo 1



Route violet  
power wire to a switched  
12V power source

Fuse  
Panel

Photo 2



Connect BSC  
wiring to  
main harness

Photo 3



www.vintageair.com

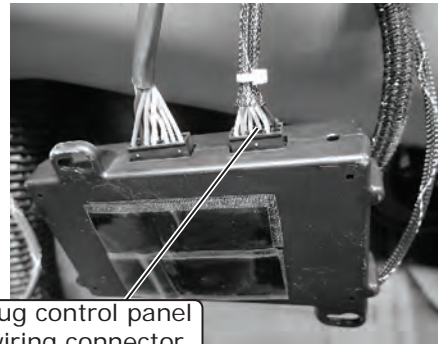
## ECU Installation

1. Plug the main wiring harness black connector into the ECU module (See Photo 1, below).
2. Install the converted/upgrade control panel and trim into the dash using the OEM hardware.
3. Plug the control panel connector into the ECU module (See Photo 2, below).
4. Apply (2) strips of Velcro and mount the ECU to the right of the radio on the inner dash. **NOTE: Make sure the area is clean and free of debris before applying Velcro.**



Plug main wiring harness connector into ECU module

Photo 1



Plug control panel wiring connector into ECU module

Photo 2

## Defrost Plenum Installation

1. Install the driver-side and passenger-side defrost hoses onto the defrost plenum.
2. Attach the defrost plenum to the evaporator module using (2) spring clips (See Photos 1 and 2, below).



Defrost Plenum  
625321

Photo 1



Spring Clip Installed

Photo 2





www.vintageair.com

## Under Dash Louver Installation

1. Install the driver and passenger side under dash louvers with the flange facing the dash and kick panel as shown in Figure 1, below. Tuck the kick panel side of the louver flange behind the kick panel windlace retainer, and slide the louver up until the flange is seated against the dash. Secure the louver to the kick panel with (2) #8 x 1/2" pan head screws (See Figure 1, below). **NOTE: In most cases, the louvers will fit as described. However, due to dash and kick panel variances, the presence of aftermarket components or modifications, etc., it may be necessary to trim the louver flange and/or slightly move the parking brake lever for proper fit.**

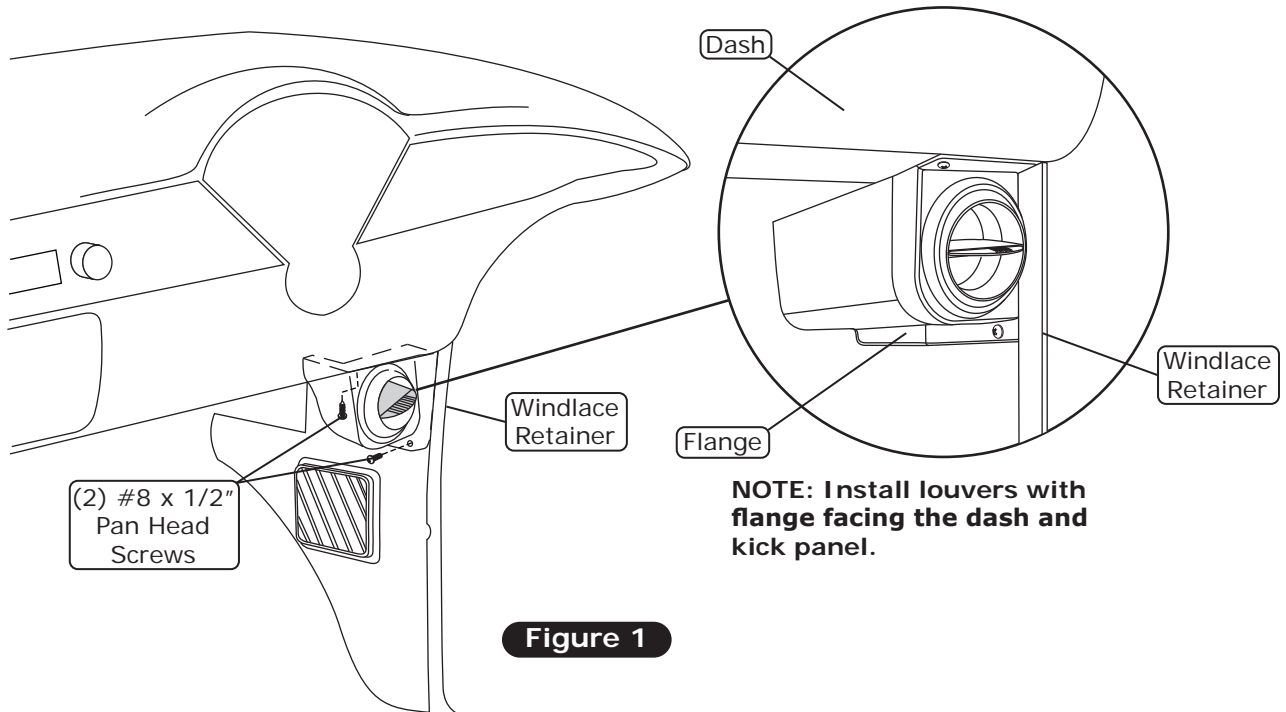


Figure 1

## Heater Hose & Heater Control Valve Installation

**NOTE: When installing the heater control valve, make sure the arrow is facing toward the evaporator module (See Figure 1, below). Measurements given for heater hose lengths in the instructions are recommended but may be modified for different applications.**

1. Cut the upper heater hose at a length of 12" from the firewall. Install the heater control valve using the supplied hose clamp (See Photo 1, below). Take note of the flow direction arrow on the valve.
2. Route the other end of the heater control valve heater hose to the intake coolant port and secure it with the supplied hose clamp (See Photo 2, below).

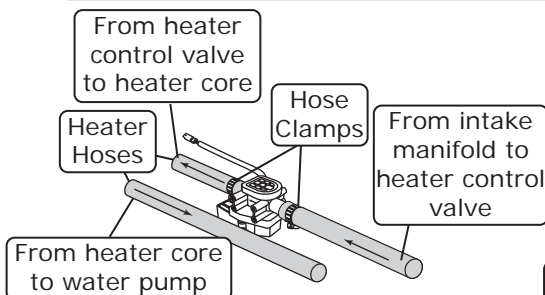
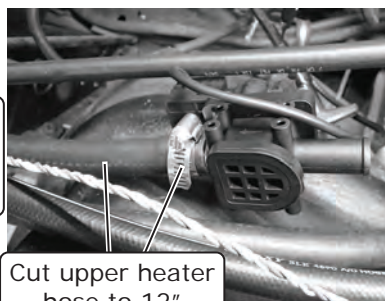


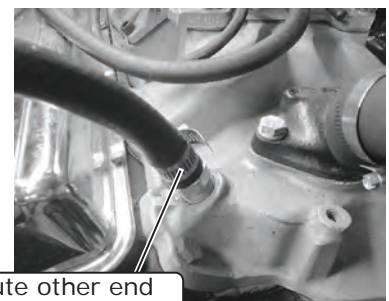
Figure 1

**NOTE: Flow Direction Follows Molded Arrow on Valve.**



Cut upper heater hose to 12" length and install heater control valve using hose clamp

Photo 1



Route other end of heater control valve heater hose to intake coolant port and secure with hose clamp

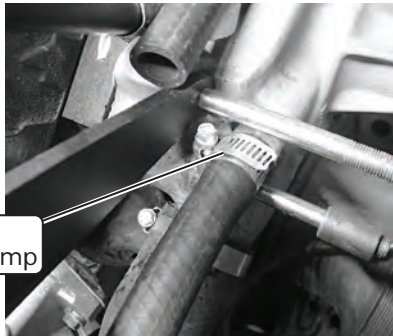
Photo 2



www.vintageair.com

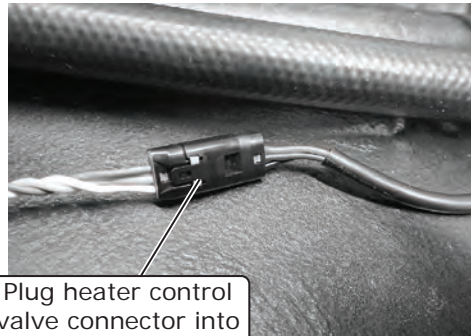
## Heater Hose & Heater Control Valve Installation (Cont.)

3. Route the lower heater hardline heater hose on the evaporator module to the water pump coolant port and secure it using the supplied hose clamp (See Photo 3, below).
4. Plug the heater control valve connector into the main wiring harness (See Photo 4, below).



Secure using supplied hose clamp

Photo 3



Plug heater control valve connector into main wiring harness

Photo 4

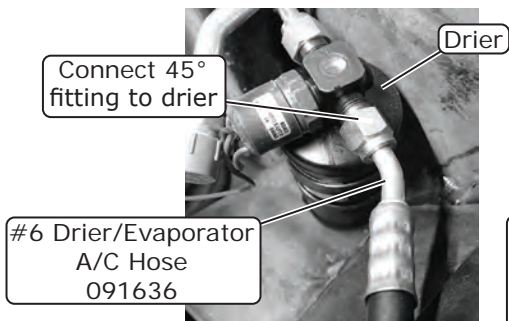
## A/C Hose Installation

### Standard Hose Kit:

1. Locate the #6 drier/evaporator A/C hose. Lubricate a #6 O-ring (See Lubricating O-rings, Page 8), and connect the 45° fitting to the drier (See Photo 1, below).
2. Locate the #8 condenser/compressor A/C hose. Lubricate (2) #8 O-rings (See Lubricating O-rings, Page 8), and connect the 135° fitting with service port to the #8 discharge port on the compressor (See Photo 2, below). Route and connect the straight fitting to the #8 condenser/compressor hardline (See Photo 3, below). Tighten each fitting connection as shown in Lubricating O-rings, Page 8.
3. Locate the #10 compressor/evaporator A/C hose. Lubricate a #10 O-ring (See Lubricating O-rings, Page 8), and connect the 135° fitting with the suction port on the compressor (See Photo 4, below).

### Modified Hose Kit:

1. Refer to separate instructions included with modified hose kit.

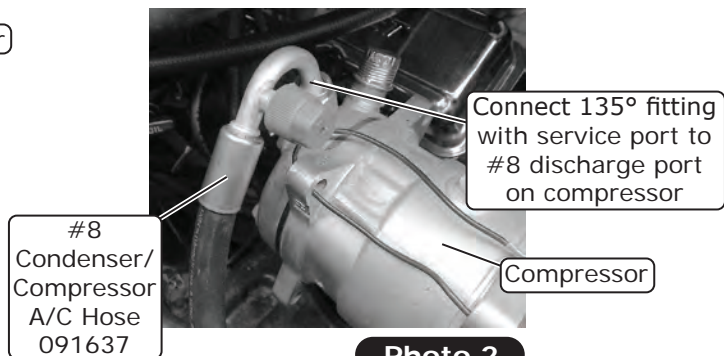


Connect 45° fitting to drier

#6 Drier/Evaporator A/C Hose 091636

Drier

Photo 1

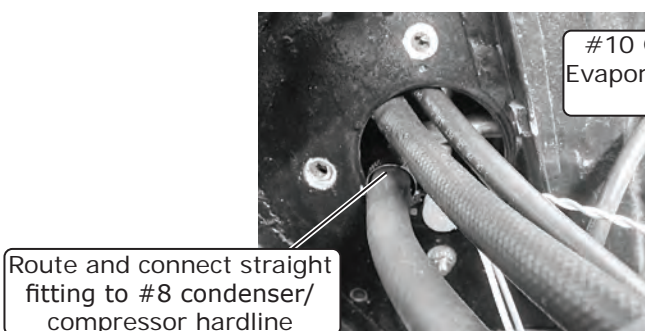


Connect 135° fitting with service port to #8 discharge port on compressor

#8 Condenser/Compressor A/C Hose 091637

Compressor

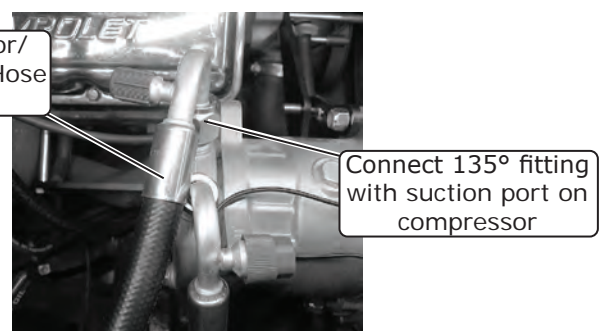
Photo 2



Route and connect straight fitting to #8 condenser/compressor hardline

#10 Compressor/Evaporator A/C Hose 091638

Photo 3



Connect 135° fitting with suction port on compressor

Photo 4





www.vintageair.com

## Engine Compartment Wiring

**NOTE:** The following connections are critical to the performance of the system. Before making connections, refer to the **Quality Crimp Guidelines, Page 26.**

1. Reinstall the battery tray and battery (See Photos 1 and 2, below).
2. Route the blue lead from the main wiring harness along the #6 A/C hose and connect it to the safety switch (See Photo 3, below).
3. Connect the compressor lead bullet connector to compressor lead then route it along the #8 A/C hose and connect it to the safety switch (See Photo 4, below).
4. Route power and ground wires toward the battery (See Photo 5, below).
5. Install the supplied heat shrink over the 12 AWG orange standard fuse holder assembly wire and crimp it to the 12 AWG orange wire from the main wiring harness (See Photo 6, below). Slide the heat shrink over the crimp, then apply heat.
6. Install the supplied heat shrink over the 16 AWG black mini fuse holder assembly wire and crimp it to the 16 AWG red wire from the main wiring harness (See Photo 7, below). Slide the heat shrink over the crimp, then apply heat.



Photo 1

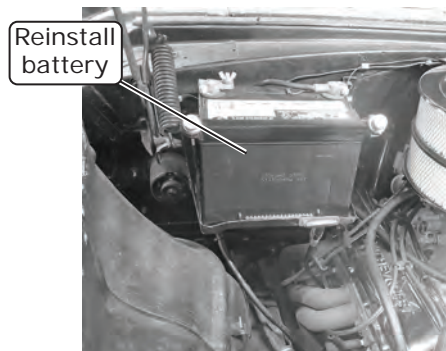


Photo 2

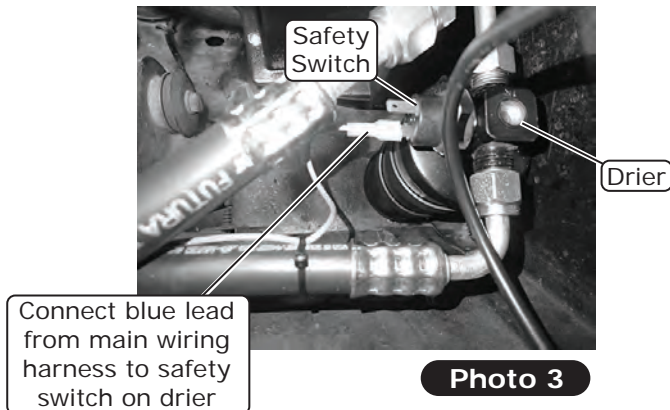


Photo 3

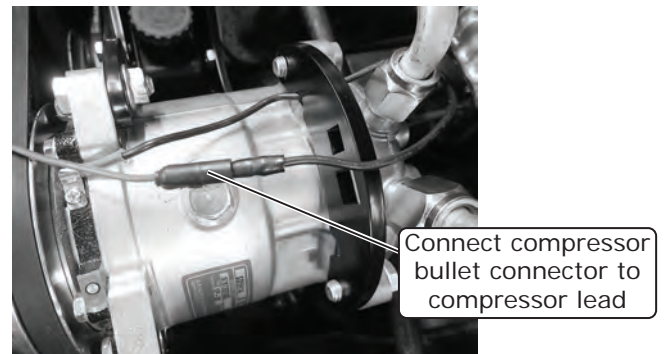


Photo 4

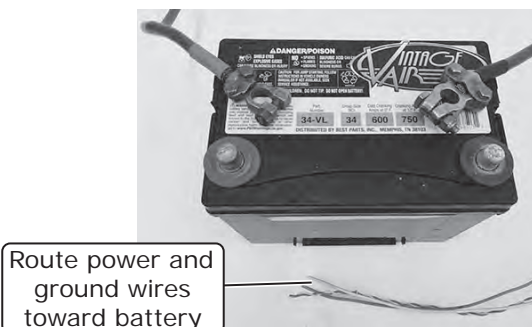


Photo 5

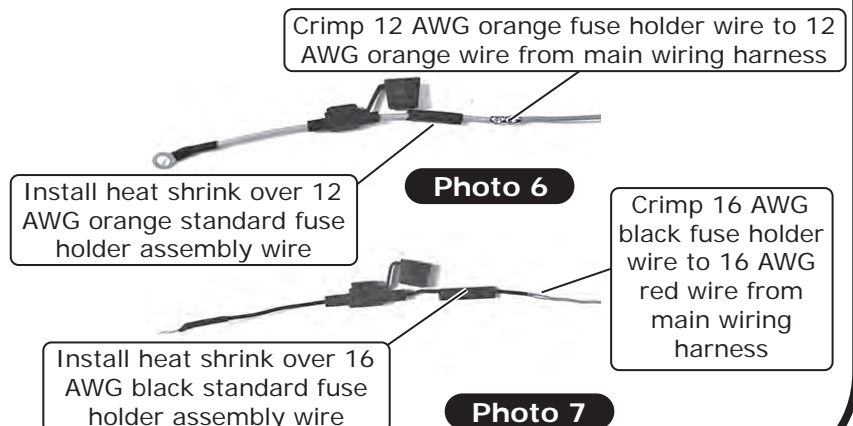


Photo 6

Photo 7



www.vintageair.com

## Engine Compartment Wiring (Cont.)

7. Install the fuses into the holders (See Photos 8 and 9, below).
8. Install the supplied heat shrink over the white ground wires, then crimp on the supplied ring terminals (See Photos 10 and 11, below). Slide the heat shrink over the crimps, then apply heat. **NOTE: Both white wires can be crimped to the larger ring terminal. Install the heat shrink, then strip the wires, twist them together and trim to length. Crimp on the ring terminal, then slide the heat shrink over and apply heat (See Photos 12 and 13, below).**



Photo 8

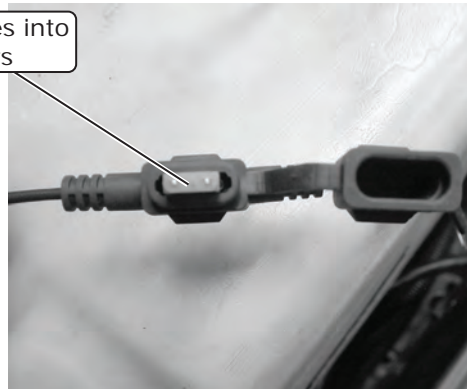


Photo 9

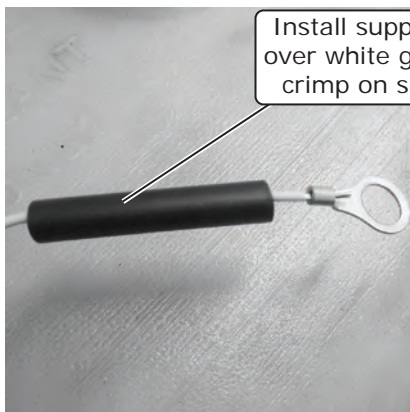


Photo 10

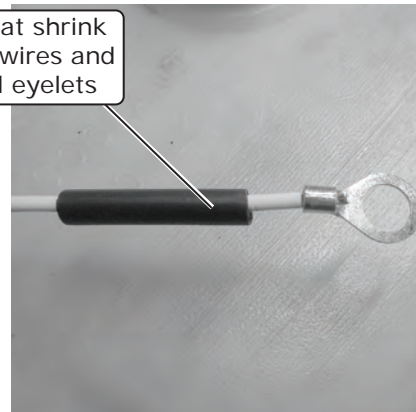


Photo 11

Both white ground wires can be crimped together. Install heat shrink, then strip wires, twist together and trim to length.

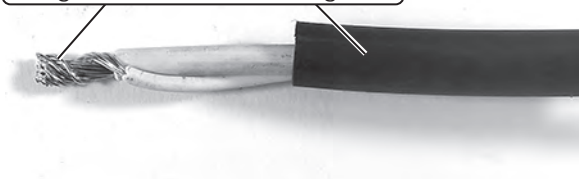


Photo 12

Crimp on ring terminal, then slide heat shrink over and apply heat

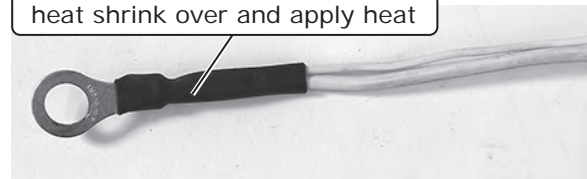


Photo 13



www.vintageair.com

## Engine Compartment Wiring (Final.)

9. Connect the ground wire ring terminals to the negative battery terminal connector (See Photos 14 and 15, below).
10. Connect the positive wire ring terminals to the positive battery terminal connector (See Photos 16 and 17, below). **NOTE: Do not connect power until the installation is completed.**
11. Wiring completed (See Photo 18, below).

Connect ground wire ring terminals to negative battery terminal  
**NOTE: Either connection application can be used.**

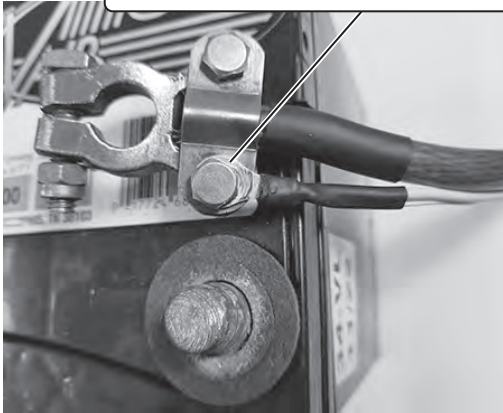


Photo 14

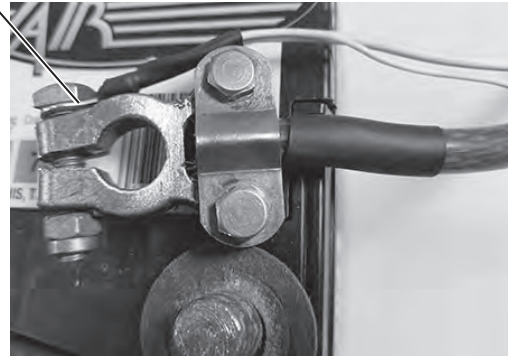


Photo 15

Connect power wire ring terminals to positive battery terminal  
**NOTE: Either connection application can be used.**

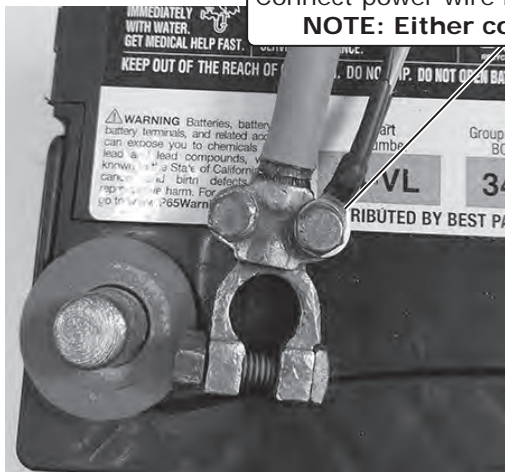
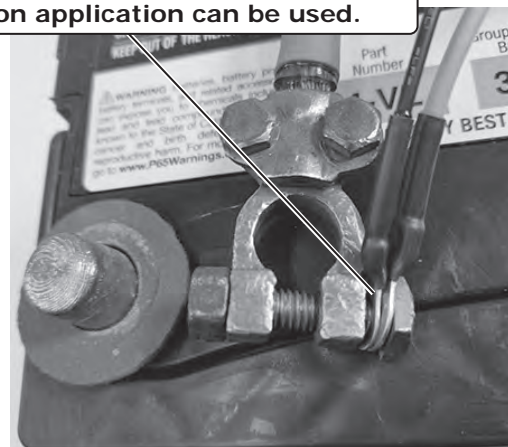


Photo 16



**NOTE: Do not connect power until installation is completed.**

Photo 17



Completed Installation Shown

Photo 18





www.vintageair.com

## Drain Hose Installation

1. Locate the evaporator drain on the bottom of the evaporator sub case.
2. In line with the drain, lightly scribe a mark on the firewall. Measure down 1" and drill a 5/8" hole through the firewall (See Figure 1, below).
3. Insert the drain hose through the previously drilled 5/8" hole, then attach it to the evaporator drain (See Photo 1, below). **NOTE: If the hole is covered by carpet, a 5/8" hole will need to be cut into the carpet as well.**

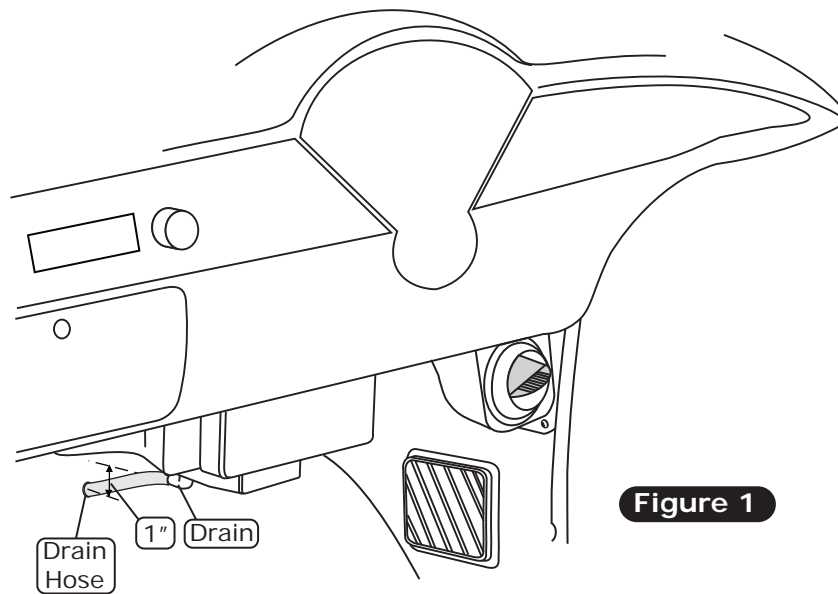


Figure 1

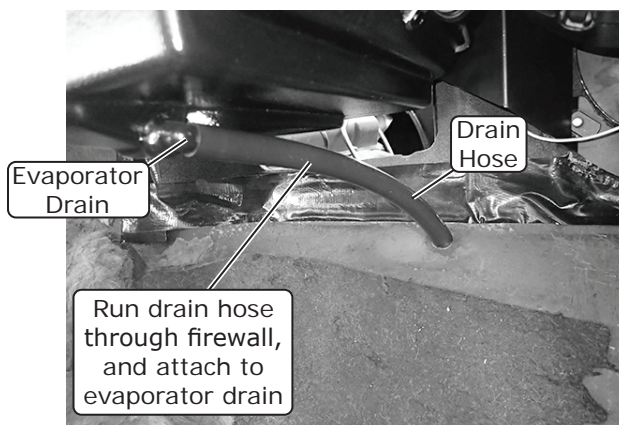


Photo 1



www.vintageair.com

# Final Steps: Installation Check

Installation Check	
ITEM TO CHECK	Procedure
<input type="checkbox"/>	<p>ECU</p> <p>If no blinking is observed after 1 minute of turning the ignition on, go to the next check.</p> <p>If repetitive blinking is observed, go to the <b>Advanced Diagnostics</b> Section to diagnose.</p>
<input type="checkbox"/>	<p>Blower speed control</p> <p>Set the blower speed control to <b>OFF</b>, <u>confirm that the blower is off</u>.</p> <p>Position the blower speed control to <b>LOW</b> then <b>MEDIUM</b> and then <b>HIGH</b>. <u>At each setting confirm that the blower speed increases</u>, do this by feeling for the amount of air coming from the unit and hearing the blower speed increase.</p>
<input type="checkbox"/>	<p>Mode control</p> <p>Set the <b>MODE</b> control to the <b>DASH</b> position. <u>Confirm that air is being blown at the dash vents</u>.</p> <p>Set the <b>MODE</b> control to the <b>FLOOR</b> position. <u>Confirm that air is being blown at the floor vents</u>.</p> <p>Set the <b>MODE</b> control to the <b>DEFROST</b> position. <u>Confirm that all air is being blown from the defrost vents</u></p> <p><b>If heater lines are installed:</b></p> <p>Set the <b>MODE</b> control to the <b>DASH</b> position. Set the <b>TEMP</b> control to the <b>MAX HEAT</b> position. <u>Confirm that HOT air is coming from the dash vents</u>.</p>
<input type="checkbox"/>	<p>Temperature control</p> <p><b>If system is charged:</b></p> <p>Set the <b>TEMP</b> control to the <b>MAX COOL</b> position. <u>Confirm that COLD air is coming from the dash vents</u>.</p> <p>Also <u>confirm that the compressor "clicks" on</u> when adjusting the <b>TEMP</b> control from the <b>MAX HEAT</b> position to the <b>MAX COOL</b> position.</p>
<input type="checkbox"/>	<p>AC Indicator (If applicable)</p> <p>While the <b>MODE</b> control is set to the <b>DASH</b> position, and the <b>TEMP</b> control is set to the <b>MAX COOL/MIN HEAT</b> position, <u>confirm that the blue AC Indicator light is on</u>.</p>
<input type="checkbox"/>	<p>Backlight (If applicable)</p> <p>If your control panel has backlight capabilities and has been wired, turn the dash lamp on and <u>confirm that the AC panel's legend is lit</u>.</p>
<input type="checkbox"/>	<p>Fittings</p> <p>Verify AC and Heater fittings are all tight.</p>

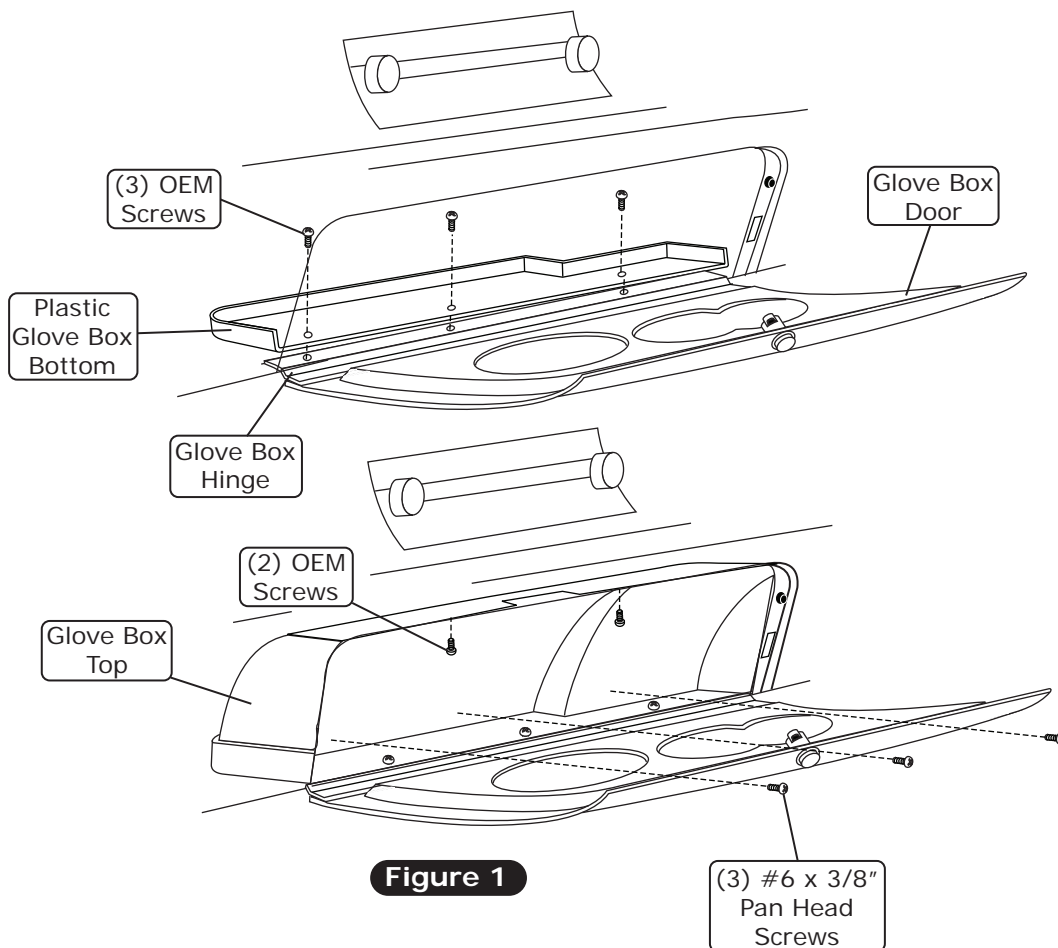




www.vintageair.com

## Glove Box Installation

1. Install the glove box bottom and glove box door. Secure to the dash with (3) OEM screws (See Figure 1, below).
2. With the glove box bottom and door in place, install the glove box top as shown in Figure 1, below. Using (3) #6 x 3/8" pan head screws, attach the glove box top to the glove box bottom as shown in Figure 1, below.
3. Secure the glove box top to the dash using (2) OEM screws (See Figure 1, below).



**Figure 1**

## Final Steps: Completing the Install

1. Reinstall all previously removed items.
2. Fill radiator with at least a 50/50 mixture of approved antifreeze and distilled water. It is the owner's responsibility to keep the freeze protection at the proper level for the climate in which the vehicle is operated. Failure to follow antifreeze recommendations will cause heater core to corrode prematurely and possibly burst in A/C mode and/or freezing weather, voiding your warranty.
3. Double check all fittings, brackets and belts for tightness.
4. Vintage Air recommends that all A/C systems be serviced by a licensed automotive A/C technician.
5. Evacuate the system for a minimum of 45 minutes prior to charging, and perform a leak check prior to servicing.
6. Charge the system to the capacities stated on Page 4 of this instruction manual.



www.vintageair.com

## Duct Hose Routing

**NOTE:** For the system to function optimally, the duct hoses must be routed as directly as possible, taking care to avoid kinks, sharp bends and unnecessary length. Vintage Air supplies duct hoses in continuous lengths that will need to be cut to size depending on application. Before cutting, familiarize yourself with the installation instructions and verify the routing will work with your application. For custom hose routing, additional hose may be needed and can be purchased from Vintage Air.

1. Stretch the duct hose until there is no slack, measure, mark and cut hose to size (See Photo 1, below).

Stretch, measure, mark and cut hose to size



Photo 1

**Disclaimer:** Before cutting duct hose to length, verify the routing will work for your application.

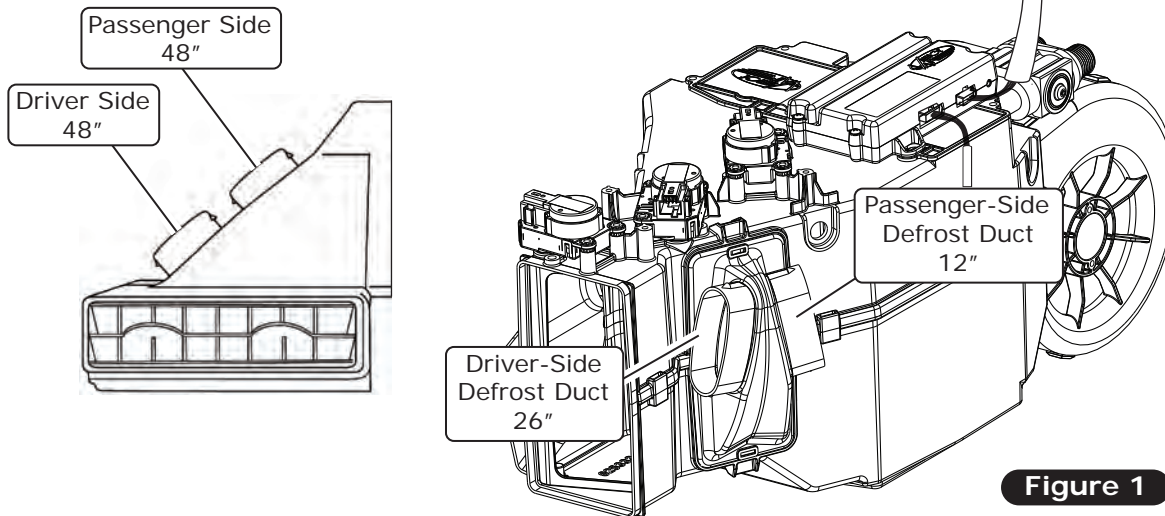


Figure 1



**NOTE:** ECU must be placed away from water and humidity, and also be accessible for servicing. If relocating, connectors must be positioned towards the bottom.

Position connectors towards bottom



www.vintageair.com

# Quality Crimp Guideline

Acceptable strip length  
(Some copper visible)

Crimped area is centered  
on each side of splice

Bad strip length  
(Too much copper visible)  
Visible copper should be  
just enough to ensure  
clearance between splice  
area and wire insulation

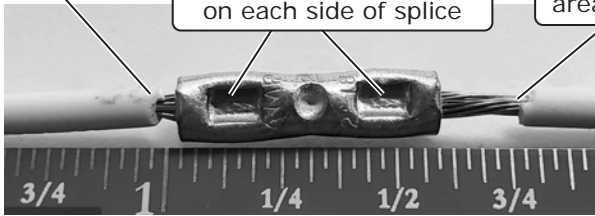


Photo 1

A good crimp requires  
seam of butt splice to be  
opposite of crimp die tooth

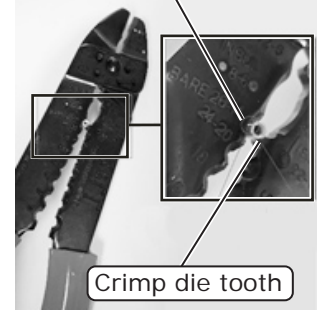


Photo 2

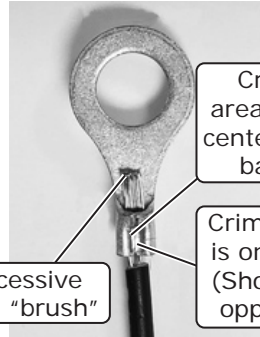
## Good Ring Terminal Crimp    Bad Ring Terminal Crimp



Crimped  
area is  
opposite  
of seam

Photo 3

Crimp  
area is  
centered  
on barrel



Crimp  
area is not  
centered on  
barrel

Excessive  
wire "brush"

Crimp area  
is on seam  
(Should be  
opposite)

Photo 4



Photo 5

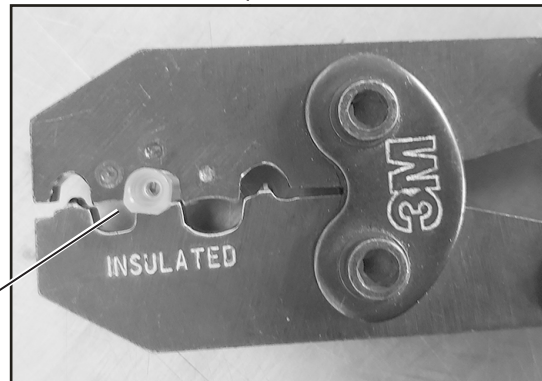


Photo 5a

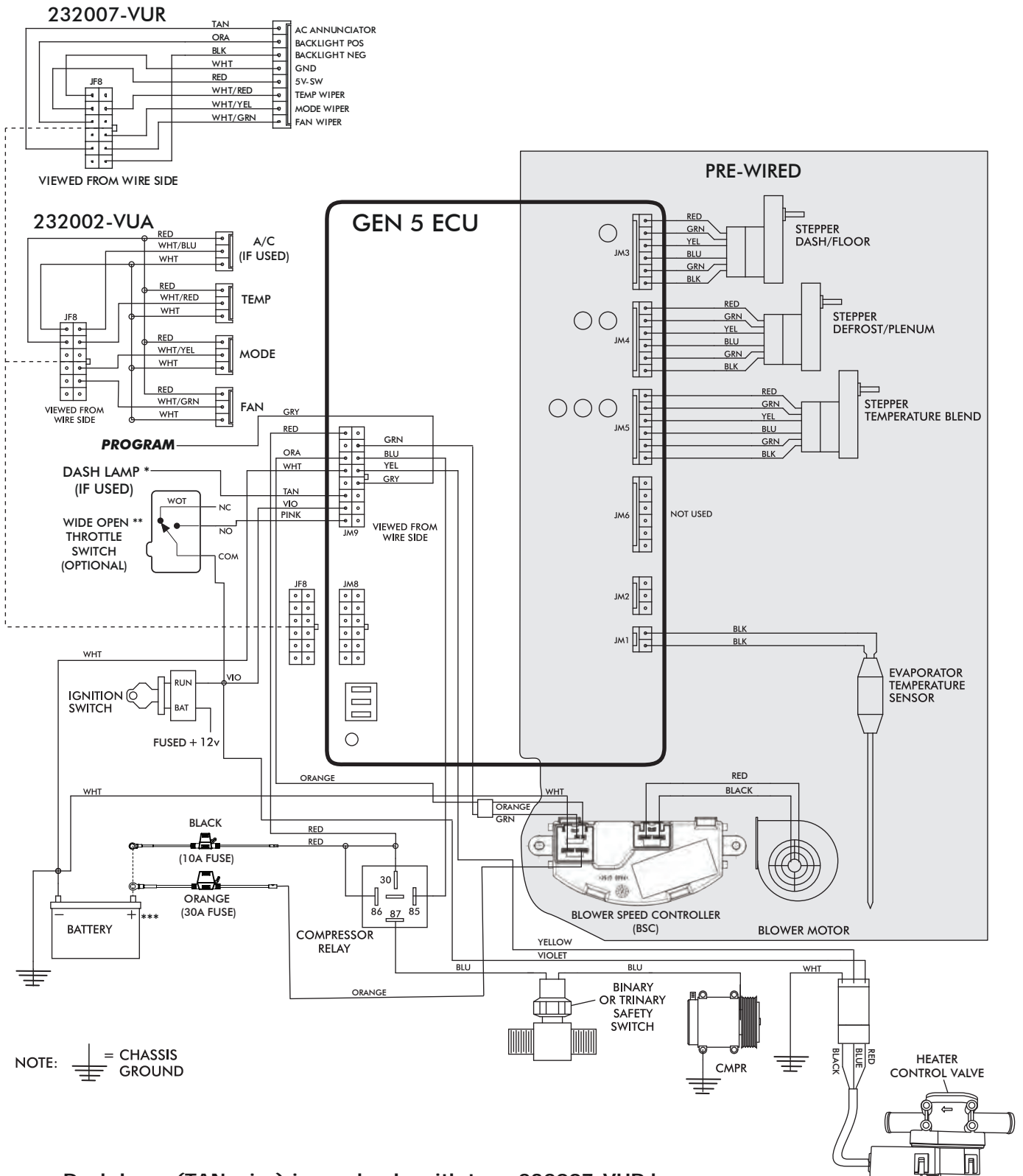
Use a ratcheting crimp tool for insulated barrel terminals when crimping the provided female insulated terminal. Ensure terminal is inserted in appropriate position before crimping.





www.vintageair.com

# Gen 5 Wiring Diagram



NOTE: = CHASSIS GROUND

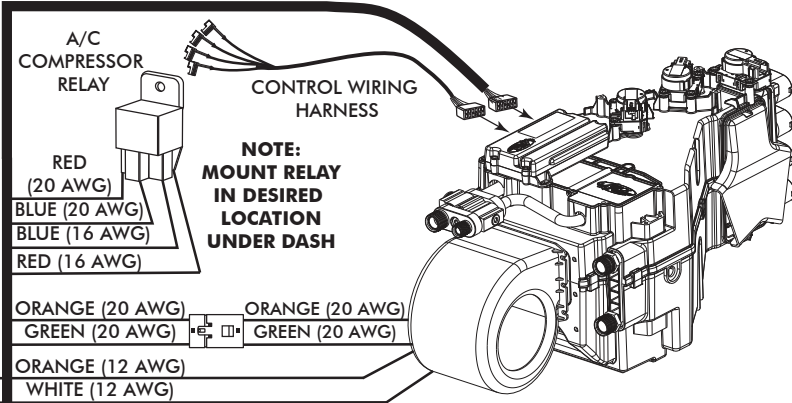
- \* Dash lamp (TAN wire) is used only with type 232007-VUR harness.
- \*\* Wide open throttle switch contacts close only at full throttle, which disables A/C compressor.
- \*\*\* Install fuse assemblies at or as near to the battery as possible.



www.vintageair.com

# Gen 5 Wiring Instructions

WIRING HARNESS (231505) ↓

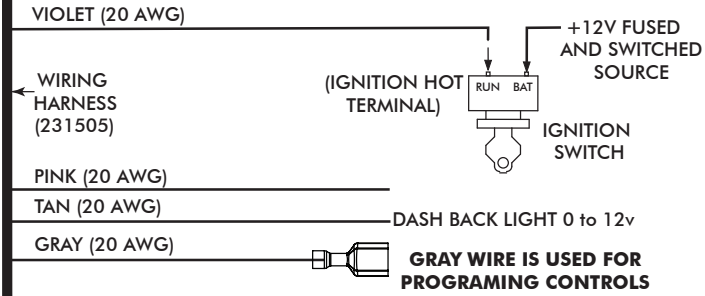


**Ignition Switch:**  
Using provided butt splice (PN 226004), connect the 20 AWG violet wire to a 5A fused and switched 12V source such as Key On.

**Wide Open Throttle Switch (Optional):**  
If a wide open throttle switch is required, connect the 20 AWG pink wire to a normally open switch that, when closed, connects a fused and switched 12V source to the pink wire. See Gen 5 wiring diagram for an example.

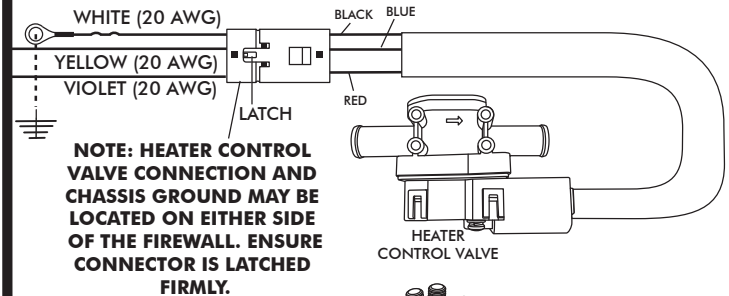
**Dash Light (Optional):**  
If using a Vintage Air control panel with back light, connect the 20 AWG tan wire to the vehicle's dash back light 0-12V using provided butt splice (PN 226004).

WIRING HARNESS (232020) →



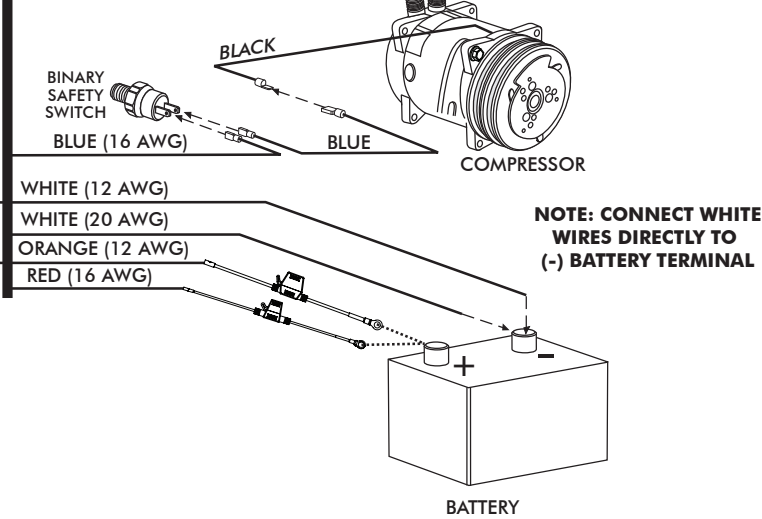
FIREWALL FIREWALL

WIRING HARNESS (232020) →



**Heater Control Valve:**  
Connect the Violet/Yellow/White twisted branch with 3 position connector into the heater control valve connector. Ensure that the mating latch is fully seated.

**Binary/Trinary & Compressor:**  
Binary Switch: Terminate provided insulated female terminal (PN 23172-VUW) to the blue 16 AWG wire. Connect as shown.  
Trinary Switch: Connect according to trinary switch wiring diagram.



**Battery Connections:**  
ECU Ground: Terminate provided ring terminal (PN 226110) to 20 AWG white wire from the 231505 wire assembly and install at battery.  
ECU PWR: Terminate provided fuse assembly with black leads (PN 233012) to the 16 AWG red wire from the 231505 wire assembly. Install provided 10A Red Mini Fuse (PN 226118). Install at battery.  
Blower Speed Controller (BSC) Ground: Terminate provided ring terminal (PN 226111) to 12 AWG white wire from the 232020 wire assembly and install at battery.  
Blower Speed Controller (BSC) PWR: Terminate provided fuse assembly with orange leads (PN 233008) to the 12 AWG orange wire from the 232020 wire assembly. Install provided 30A Green ATO/ATC Fuse (PN 226125). Install at battery.



www.vintageair.com

## Operation of Controls (Standard Control)

On Gen IV or Gen 5 systems with three lever/knob controls, the temperature control toggles between heat and A/C operations. To activate A/C, move the temperature lever/knob all the way to cold and then back it off to the desired vent temperature. For heat operation, move the temperature lever/knob all the way to hot and then adjust to the desired vent temperature. The blower will momentarily change speed, each time you toggle in and out of heat and A/C operations, to indicate the change. **NOTE: For proper control panel function, refer to Control Panel Kit instructions.**

### Blower Speed

This lever/knob controls blower speed, from OFF to HI.

### Mode Control

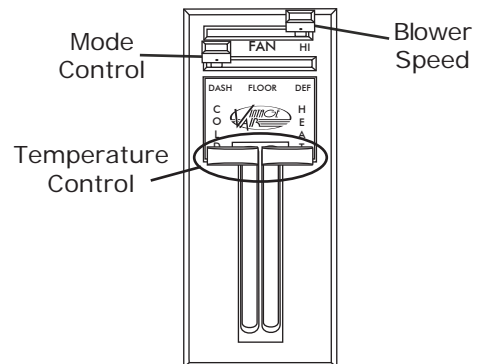
This lever/knob controls the mode positions, from DASH to FLOOR to DEFROST, with a blend in between.

### Temperature Control

This lever/knob controls the temperature, from HOT to COLD.

### \* Inside/Outside Air Control

The inside/outside air control operates the fresh air door. **NOTE: For optimal system performance, use inside air.**



### *A/C Operation*

### Blower Speed

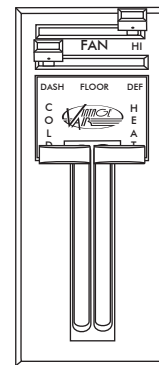
Adjust to desired speed.

### Mode Control

Adjust to desired mode position (DASH position recommended).

### Temperature Control

For A/C operation, adjust to coldest position to engage compressor (Adjust between HOT and COLD to reach desired temperature).



### *Heat Operation*

### Blower Speed

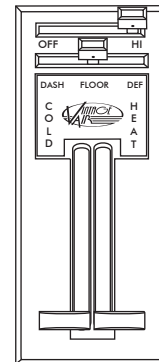
Adjust to desired speed.

### Mode Control

Adjust to desired mode position (FLOOR position recommended).

### Temperature Control

For maximum heating, adjust to hottest position (Adjust between HOT and COLD to reach desired temperature).



### *Defrost/De-fog Operation*

### Blower Speed

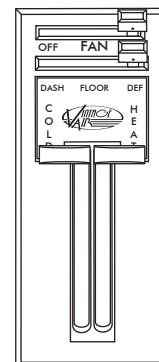
Adjust to desired speed.

### Temperature Control

Adjust to desired temperature.

### Mode Control

Adjust to DEFROST position for maximum defrost, or between FLOOR and DEFROST positions for a bi-level blend (Compressor is automatically engaged).







www.vintageair.com

## Operation of Controls (Deluxe Control)

On Gen IV and Gen 5 systems with three lever/knob controls, the temperature control toggles between heat and A/C operations. To activate A/C, move the temperature lever/knob all the way to cold and then back it off to the desired vent temperature. For heat operation, move the temperature lever/knob all the way to hot and then adjust to the desired vent temperature. The blower will momentarily change speed, each time you toggle in and out of heat and A/C operations, to indicate the change. **NOTE: For proper control panel function, refer to Control Panel kit instruction for calibration procedure.**

### Blower Speed

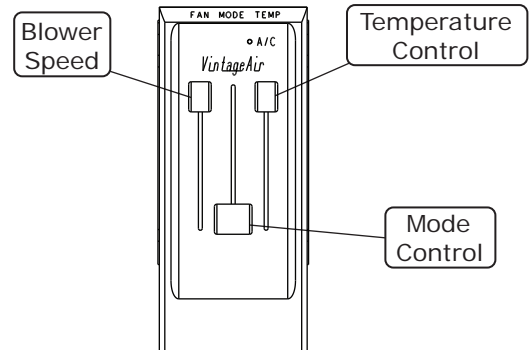
This lever/knob controls blower speed, from OFF to HI.

### Mode Control

This lever/knob controls the mode positions, from DASH to FLOOR to DEFROST, with a blend in between.

### Temperature Control

This lever/knob controls the temperature, from HOT to COLD.



### *A/C Operation*

### Blower Speed

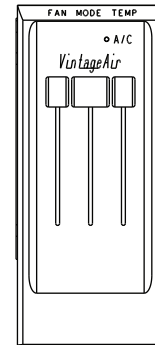
Adjust to desired speed.

### Mode Control

Adjust to desired mode position (DASH position recommended).

### Temperature Control

For A/C operation, adjust to coldest position to engage compressor (Adjust between HOT and COLD to reach desired temperature).



### *Heat Operation*

### Blower Speed

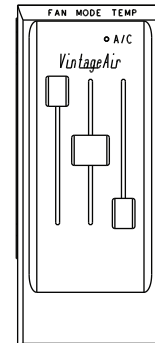
Adjust to desired speed.

### Mode Control

Adjust to desired mode position (FLOOR position recommended).

### Temperature Control

For maximum heating, adjust to hottest position (Adjust between HOT and COLD to reach desired temperature).



### *Defrost/De-fog Operation*

### Blower Speed

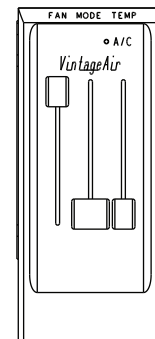
Adjust to desired speed.

### Temperature Control

Adjust to desired temperature.

### Mode Control

Adjust to DEFROST position for maximum defrost, or between FLOOR and DEFROST positions for a bi-level blend (Compressor is automatically engaged).





www.vintageair.com

# Troubleshooting Guide

This printed troubleshooting guide is our basic guide that covers common installation problems. To see our advanced diagnostics and troubleshooting guide, please refer to the following page for instructions on how to download the complete guide.

**WARNING: While troubleshooting the system, never probe connector terminals from the front mating side, only back probe.**

**WARNING: While troubleshooting the system, never use automotive check lights.**

Symptom	Condition	Checks	Actions	Notes
1. Blower stays on high speed with ignition on.	No other functions work.	Check for damaged pins or wires in the control panel wire assembly and mating header at ECU.	If found damaged, replace wire assembly or ECU.	If fuse continues to blow, there is a serious problem in the wiring. Check all wiring and ensure the wire is not damaged and shorting out along its route.
	All other functions work.	Check for a bad ECU GND. Check for damaged pins or wires in the control panel wire assembly and mating header at ECU. Check if Blower power fuse is blown. Check for a bad ECU GND.	If found damaged, replace wire assembly or ECU. Replace fuse. Repair connection.	
2. Compressor will not turn on (All other functions work).	System is not charged.	System must be charged for compressor to engage.	Charge system.	<b>Danger: Never bypass safety switch with engine running. Serious injury can result.</b>
	System is charged.	Check for faulty A/C potentiometer or associated wiring (not applicable to 3-pot controls). Check for disconnected or faulty thermistor.	Check continuity to ground on white control head wire. Check for 5V on red control head wire. Check 2-pin connector at ECU housing.	To check for proper pot function, check voltage at white/red wire. Voltage should be between 0V and 5V, and will vary with pot lever position. Disconnected or faulty thermistor will cause compressor to be disabled.
	Compressor will not turn off (All other functions work).	Check for faulty A/C potentiometer or associated wiring.	Repair or replace pot/control wiring.	Red wire at A/C pot should have approximately 5V with ignition on. White wire will have continuity to chassis ground. White/Red wire should vary between 0V and 5V when lever is moved up or down.
3. Compressor will not turn off (All other functions work).	System is charged.	Check for faulty A/C relay.	Replace relay.	



www.vintageair.com

# Troubleshooting Guide (Cont.)

Symptom	Condition	Checks	Actions	Notes
4. System will not turn on, or runs intermittently.	Works when engine is not running; shuts off when engine is started	Noise interference from either ignition or alternator.	Install capacitors on ignition coil and alternator. Ensure good ground at all points. Relocate coil and associated wiring away from ECU and ECU wiring. Check for burned or loose plug wires.	Ignition noise (radiated or conducted) will cause the system to shut down due to high voltage spikes. If this is suspected, check with a quality oscilloscope. Spikes greater than 16V will shut down the ECU. Install a radio capacitor at the positive post of the ignition coil (see radio capacitor installation bulletin). A faulty alternator or worn out battery can also result in this condition.
	Will not turn on under any conditions.	Verify connections on power lead, ignition lead, and both white ground wires. Verify battery voltage is greater than 10 volts and less than 16 while engine is running.	Check for power at ECU, and confirm ignition is being applied to ECU properly. Verify proper meter function by checking the condition of a known good battery.	
5. Loss of mode door function.	No mode change at all.	Check for damaged mode switch or potentiometer and associated wiring.		
	Blower turns on and off rapidly.	Battery voltage is at least 12V. Battery voltage is less than 12V.	Ensure all system grounds and power connections are clean and tight. Charge battery.	System shuts off blower at 10V. Poor connections or weak battery can cause shutdown at up to 11V.
7. Erratic functions of blower, mode, temp, etc.		Check for damaged switch or pot and associated wiring.	Repair or replace.	

## Advanced Diagnostics and Troubleshooting Guide

If after referencing the Troubleshooting Guide, the issue is not resolved, move to The Advanced Diagnostics and Troubleshooting Guide that covers the following:

- **ECU Diagnostics Codes**
  1. ECU Blink Sequence
  2. Firmware Version Number
  3. ECU Model Number
  4. ECU Start-Up Blink Sequence
  5. Diagnostic Codes
- **Complete Advanced Troubleshooting Guidelines**

Access the latest version of the Advanced Diagnostics and Troubleshooting Guide by scanning the following QR code on your mobile device:



You can also access the guide by typing the following address into your web browser:

[https://www.vintageair.com/instructions\\_pdf/905000.pdf](https://www.vintageair.com/instructions_pdf/905000.pdf)







www.vintageair.com

## Packing List: Evaporator Kit (561550)

No.	Qty.	Part No.	Description
1.	1	765200	Gen 5 Magnum Max Module with 404 ECU
2.	1	781550	Accessory Kit

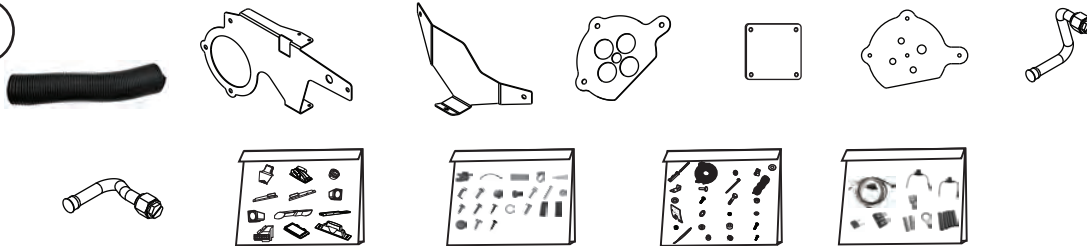
Checked By: \_\_\_\_\_  
Packed By: \_\_\_\_\_  
Date: \_\_\_\_\_

1

Gen 5 Magnum Max  
Module with 404 ECU  
765200



2



Accessory Kit  
781550

NOTE: Images may not depict actual parts and quantities.  
Refer to packing list for actual parts and quantities.

## Packing List: Evaporator Kit (561554)

No.	Qty.	Part No.	Description
1.	1	765200	Gen 5 Magnum Max Module with 404 ECU
2.	1	781554	Accessory Kit

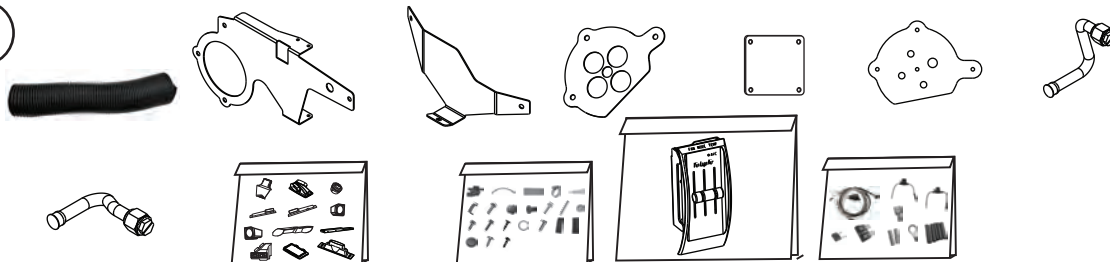
Checked By: \_\_\_\_\_  
Packed By: \_\_\_\_\_  
Date: \_\_\_\_\_

1

Gen 5 Magnum Max  
Module with 404 ECU  
765200



2



Accessory Kit  
781554  
Deluxe

NOTE: Images may not depict actual parts and quantities.  
Refer to packing list for actual parts and quantities.